

Agilent Technologies 8510C Network Analyzer System

Operating and Programming Manual

For use with Firmware Revision C.07.XX with CRT display

For use with Firmware Revision C.08.XX or greater with LCD

Serial Numbers

This manual applies directly to instruments with
this serial prefix number or above: 3031A.



Agilent Technologies

Part Number: 08510-90281

**Printed in USA
May 2001**

Edition 3.0
Supersedes January 31, 1994

© Copyright Agilent Technologies 1989, 1994, 2001

Certification

Agilent Technologies certifies that this product met its published specifications at the time of shipment from the factory. Agilent further certifies that its calibration measurements are traceable to the United States National Institute of Standards and Technology, to the extent allowed by the Institute's calibration facility, and to the calibration facilities of other International Standards Organization members.

Warranty

This Agilent instrument product is warranted against defects in material and workmanship for a period of one year from date of delivery. During the warranty period, Agilent will, at its option, either repair or replace products which prove to be defective.

For warranty service or repair, this product must be returned to a service facility designated by Agilent Technologies. Buyer shall prepay shipping charges to Agilent and Agilent shall pay shipping charges to return the product to Buyer. However, Buyer shall pay all shipping charges, duties, and taxes for products returned to Agilent from another country.

Agilent warrants that its software and firmware designated by Agilent for use with an instrument will execute its programming instructions when properly installed on that instrument. Agilent does not warrant that the operation of the instrument, or software, or firmware will be uninterrupted or error free.

Limitation of Warranty

The foregoing warranty shall not apply to defects resulting from improper or inadequate maintenance by Buyer, Buyer-supplied software or interfacing, unauthorized modification or misuse, operation outside of the environmental specifications for the product, or improper site preparation or maintenance.

NO OTHER WARRANTY IS EXPRESSED OR IMPLIED. AGILENT SPECIFICALLY DISCLAIMS THE IMPLIED WARRANTIES OF MERCHANTABILITY AND FITNESS FOR A PARTICULAR PURPOSE.

EXCLUSIVE REMEDIES

THE REMEDIES PROVIDED HEREIN ARE BUYER'S SOLE AND EXCLUSIVE REMEDIES. Agilent SHALL NOT BE LIABLE FOR ANY DIRECT, INDIRECT, SPECIAL, INCIDENTAL, OR CONSEQUENTIAL DAMAGES, WHETHER BASED ON CONTRACT, TORT, OR ANY OTHER LEGAL THEORY.

Safety and Regulatory Information

Review this product and related documentation to familiarize yourself with safety markings and instructions before you operate this instrument.

This product has been designed and tested in accordance with the standards listed on the Manufacturer's Declaration of Conformity, and has been supplied in a safe condition. The documentation contains information and warnings that must be followed by the user to ensure safe operation and to maintain the product in a safe condition.

Caution The CAUTION notice denotes a hazard. It calls attention to a procedure which, if not correctly performed or adhered to, could result in damage to or destruction of the instrument. Do not proceed beyond a *caution* sign until the indicated conditions are fully understood and met.

Warning The WARNING notice denotes a hazard. It calls attention to a procedure which, if not correctly performed or adhered to, could result in injury or loss of life. Do not proceed beyond a WARNING sign until the indicated conditions are fully understood and met.



When you see this symbol on your instrument, you should refer to the instrument's instruction manual for important information.



The CSA mark is the Canadian Standards Association safety mark.



The CE mark is a registered trademark of the European Community. If it is accompanied by a year, it indicates the year the design was proven.



This symbol indicates that the instrument requires alternating current (ac) input.



This symbol is used to mark the STANDBY/OFF position of the power line switch.



This symbol is used to mark the ON position of the power line switch.

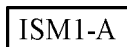

This text indicates that the instrument is an industrial Scientific and Medical Group 1 Class A product (CISPER 11, Clause 4).



The C-tick mark is a registered trademark of the Spectrum Management Agency of Australia. This signifies compliance with the Australian EMC Framework regulations under the terms of Radio communications Act of 1992.

General Safety Considerations

- Warning**
- **This is a Safety Class 1 Product (provided with a protective earthing ground incorporated in the power cord). The mains plug shall only be inserted in a socket outlet provided with a protective earth contact. Any interruption of the protective conductor inside or outside of the product is likely to make the product dangerous. Intentional interruption is prohibited.**
 - **Before applying power, verify that the product is configured to match the available main power source as described in the input power configuration instructions. If this product is to be powered by autotransformer, make sure the common terminal is connected to the neutral (grounded) side of the ac power supply.**
 - **If this product is not used as specified, the protection provided by the equipment could be impaired. This product must be used in a normal condition (in which all means for protection are intact) only.**
-

- Caution**
- Always use the three-prong AC power cord supplied with this product. Failure to ensure adequate earth grounding by not using this cord may cause product damage.
 - Ventilation Requirements: When installing the product in a cabinet, the convection into and out of the product must not be restricted. The ambient temperature (outside the cabinet) must not be restricted. The ambient temperature (outside the cabinet) must be less than the maximum operating temperature of the product by 4° for every 100 watts dissipated in the cabinet. If the total power dissipated in the cabinet is greater than 800 watts forced convection must be used.
 - This product is designed for use in Installation Category II and Pollution Degree 2 per IEC 1010 and 664 respectively.
-

Acoustic Noise Emissions Declaration

This is to declare that this instrument is in conformance with the German Regulation on Noise Declaration for Machines (Laermangabe nach der Maschinenlaermrerordnung –3. GSGV Deutschland).

Acoustic Noise Emission/Geraeuschemission	
LpA < 70 dB	LpA < 70 dB
Operator position	am Arbeitsplatz
normal operation	normaler Betrieb
Per ISO 7779	nach DIN 45635 t. 19

By internet, phone, or fax, get assistance with all your test & measurement needs.

Table 0-1. Contacting Agilent

Online Assistance: www.agilent.com/find/assist

United States

(tel) 1 800 452 4844

Japan

(tel) (81) 426 56 7832

(fax) (81) 426 56 7840

New Zealand

(tel) 0 800 738 378

(fax) 64 4 495 8950

Canada

(tel) 1 877 894 4414

(fax) (905) 206 4120

Latin America

(tel) (305) 269 7500

(fax) (305) 269 7599

Asia Pacific

(tel) (852) 3197 7777

(fax) (852) 2506 9284

Europe

(tel) (31 20) 547 2323

(fax) (31 20) 547 2390

Australia

(tel) 1 800 629 485

(fax) (61 3) 9210 5947

Introduction

This *8510C Operating and Programming Manual* is designed to provide you with comprehensive tutorial material to help you learn typical applications and operating details of the Agilent 8510 network analyzer system.

A companion volume, the *8510 Keyword Dictionary* provides a complete alphabetical list of 8510 front-panel hardkeys, menu softkeys, and programming mnemonics. Each entry also includes information about how to use the function in programmed operation.

-
- Note** The original 8510C incorporated a cathode ray tube (CRT) based display. The current design incorporates a liquid crystal display (LCD). In this manual references to either CRT or LCD apply to both display designs unless noted otherwise.
- Systems with a CRT based display in the 85101C use firmware revision C.07.XX or greater.
 - Systems with an LCD require firmware revision C.08.00 or greater.

Note In this manual, the terms GPIB (General Purpose Interface Bus) and HP-IB (Hewlett-Packard Interface Bus) refer to the same protocol. Instrument softkeys for HP-IB related functions use “HP-IB”, for example, `HP-IB ADDRESSES` or `HP-IB CONFIGURE`.

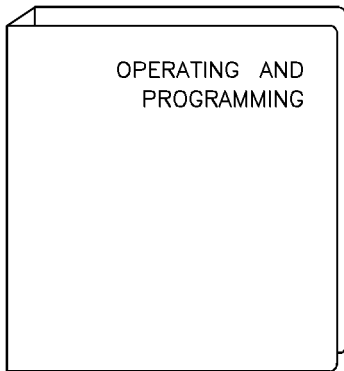

Front Panel Operation.
Remote Operation (Programming).
Operating and Programming Applications and Examples
for Transmission, Reflection, and Time Domain Measurements.
Circuit Modeling Program.
General Applications (Product Notes).

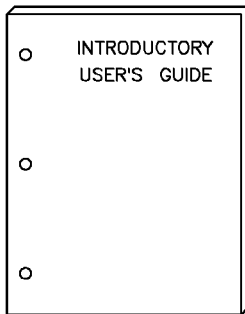

Example Procedures
to illustrate Operating Sequences.

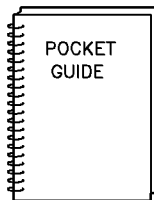

Operating and Programming
Quick Reference.

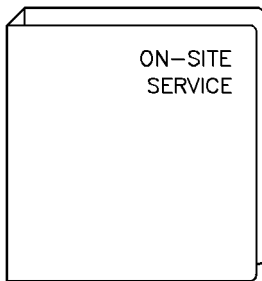

System Installation.
Theory of Operation.
Troubleshooting to the Instrument and Assembly Levels.
Replaceable Parts and Replacement Procedures.
Adjustments.
Specifications and Performance Verification.
Preventive Maintenance.

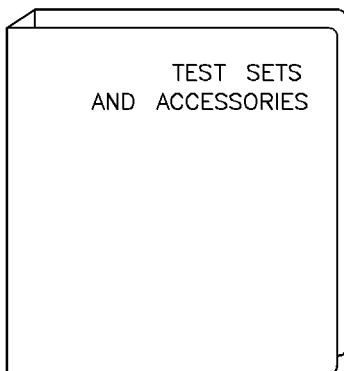

This binder contains tabs only. The following pieces
must be ordered separately:

Test Set Operation, Repair and Replaceable Parts.
Calibration Kit Operation and Repair.
Verification Kit Operation and Repair.
Adapter Set and Adapter Kit Operation and Repair.
Test Port Cables Operation and Repair.
Mounting Rack and Fixtures General Information.

docmap2

Typeface Conventions

The following conventions are used in the *8510C Operating and Programming Manual* and the *Keyword Dictionary*.

Italics

Italic type is used for emphasis, and for titles of manuals and other publications. It is also used to designate a variable entry value.

Computer

Computer type is used for information displayed on the instrument and to designate a programming command or series of commands.

Hardkeys

Instrument keys are represented in “key cap.” You are instructed to *press* a hardkey.

Softkeys

Softkeys are located along side of the display, and their functions depend on the current display. These keys are represented in “softkey.” You are instructed to *select* a softkey.

DECLARATION OF CONFORMITY

According to ISO/IEC Guide 22 and CEN/CENELEC EN 45014

Manufacturer's Name: Agilent Technologies, Inc.

Manufacturer's Address: 1400 Fountaingrove Parkway
Santa Rosa, CA 95403-1799
USA

Declares that the product:

Product Name: Network Analyzer

Model Number: 8510C

Product Options: This declaration covers all options of the above product.

Conforms to the following product specifications:

EMC: IEC 61326-1:1997+A1:1998 / EN 61326-1:1997+A1:1998
CISPR 11:1990 / EN 55011-1991 (Group 1, Class A)
IEC 61000-4-2:1995+A1998 / EN 61000-4-2:1995 (4 kV CD, 8 kV AD)
IEC 61000-4-3:1995 / EN 61000-4-3:1995 (3 V/m, 80 - 1000 MHz)
IEC 61000-4-4:1995 / EN 61000-4-4:1995 (0.5 kV sig. lines, 1 kV power lines)
IEC 61000-4-5:1995 / EN 61000-4-5:1996 (0.5 kV L-L, 1 kV L-G)
IEC 61000-4-6:1996 / EN 61000-4-6:1998 (3 V, 0.15 – 80 MHz)
IEC 61000-4-11:1994 / EN 61000-4-11:1998 (1 cycle, 100%)

Safety: IEC 61010-1:1990 + A1:1992 + A2:1995 / EN 61010-1:1993 +A2:1995
CAN/CSA-C22.2 No. 1010.1-92

Supplementary Information:

The product herewith complies with the requirements of the Low Voltage Directive 73/23/EEC and the EMC Directive 89/336/EEC and carries the CE-marking accordingly.

Santa Rosa, CA, USA 28 February, 2001



Greg Pfeiffer/Quality Engineering Manager

For further information, please contact your local Agilent Technologies sales office, agent or distributor.

Contents

1. Introduction to the 8510C Network Analyzer System	
Introduction	1-1
8510 Network Analyzer System Description	1-1
Front Panel Controls	1-2
Display Modes and Annotation Areas	1-3
Channel/Parameter Identification Area	1-4
Stimulus Values Area	1-4
Active Entry Area	1-5
Knowing When a Function Is Selected	1-5
Recognizing Mutually-Exclusive Functions	1-5
Title Area	1-5
System Messages Area	1-5
Enhancement Annotation Area	1-6
Softkey Menu and Marker List Display Area	1-6
Using ENTRY Block Keys	1-7
Uparrow (▲) and Downarrow (▼) Keys	1-7
Using Numeric Keys	1-7
Using Units Terminator Keys	1-8
Using the Prior Menu Key	1-8
Using the Backspace Key	1-8
Using the MARKER Key	1-8
Using ACTIVE CHANNEL Block Keys	1-9
Coupling Channels	1-9
Coupling Conditions	1-10
Using MENUS Block Keys	1-10
Using STIMULUS, PARAMETER, FORMAT, and RESPONSE Blocks Keys	1-11
Using INSTRUMENT STATE Keys	1-12
Using AUXILIARY MODE Keys	1-12
Using MEASUREMENT Block Key	1-12
Using the Menus, Examples	1-13
To Create, Edit, or Delete a Title	1-13
To Adjust the Date/Time Clock	1-13
The Analyzer Remembers Previous Settings (Limited Instrument State)	1-14
INSTRUMENT STATE Block	1-15
USER PRESET Key	1-15
Saving and Recalling Complete Instrument States	1-15
LOCAL Key	1-16

2. Introductory Measurement Sequence	
Introduction	2-1
Verifying the System Setup	2-1
If some instruments do not respond at power-up	2-2
Turning on system power, the sequence	2-2
Waiting for self-test and initialization	2-3
Measurement Sequence Example 1: Frequency Domain Measurement	2-3
1. Setting Up the Measurement	2-4
Making Connections	2-4
Factory Preset State	2-5
Set Stimulus, Parameter, Format, Response	2-5
2. Performing the Measurement Calibration	2-7
Making a reflection frequency response calibration	2-7
To Identify, Create, and Store S_{11} Measurement Calibration Data	2-7
Reading the displayed response	2-8
Making a transmission frequency response calibration	2-8
To Identify, Create, and Store S_{21} Measurement Calibration Data	2-8
3. Making a Measurement	2-9
To measure return loss (S_{11}) in LOG MAG format (frequency domain measurements)	2-9
To measure the insertion loss (S_{21}) in LOG MAG format	2-10
4. Saving Data and Getting an Output of the Results	2-11
Plotting Advantages	2-11
To set up the plotter	2-11
Plotting the Current Display	2-12
To plot selected areas of the results display	2-12
Measurement Sequence Example 2: Time Domain	2-13
3. Principles of Operation	
Introduction	3-1
Basic Principles of Network Measurements	3-1
System Block Diagram	3-3
Description of the 8510 Network Analyzer	3-3
How the 8510 Makes Measurements	3-4
Test and Measurement Input Channels	3-4
Ratio Measurements and Sampling Details	3-4
Digital Signal Processing	3-5
CPU and Memory Description	3-5
Data Processing Steps	3-5
Button Push Detection	3-6
Test Signal Sources	3-6
Sources in ramp-sweep mode	3-7
Sources in step-sweep mode	3-7
Test Sets	3-7
Coaxial Test Set Information	3-7
Reflection/Transmission Test Sets	3-8
S-Parameter Test Sets	3-9
Customized Test Sets	3-10
Measurement Accessories	3-11
Source Output-to-Test-Set Input Signal Cable	3-11
Test Port Return Cables	3-11

Extension Lines	3-11
Adapters (To Protect Test Ports from Wear)	3-13
Proper Connector Care and Use	3-13
Calibration Kits	3-13
Verification Kits	3-14
Automatic Recall of Instrument Settings	3-15
The Added Benefit of the SAVE/RECALL Feature	3-15
Factory Preset State	3-16
Hardware State	3-17

4. Measurement Controls

Display	4-1
Display Modes	4-2
Dual Channel Display Modes	4-3
Single Channel, Four Parameter Display Modes	4-5
Adjust Display Menu	4-5
Intensity	4-5
Background Intensity (CRT only)	4-6
Modify colors	4-6
Default Colors	4-8
External Video (CRT only)	4-9
External Video (LCD only)	4-10
Limits: Limit Lines and Limit Points Measurements	4-11
Types of Limits	4-11
Limit Testing	4-11
Limit Tables	4-12
Creating a Limit Test	4-12
To Set Up the Measurement	4-12
To Set the Limit Test Values	4-13
To Define the Maximum Limit	4-13
To Define Minimum Limit Lines	4-15
Editing Limits in the Limits Table	4-16
Trace Memory Operations	4-17
Storing Trace Data in Memory	4-17
To Display a Stored Trace	4-17
Settings that can and cannot be changed	4-17
To Display Data and Memory Simultaneously	4-17
Settings that can and cannot be changed	4-17
To Select the Default Memory	4-18
Which memory locations are volatile, which are not	4-20
What is the operational life of non-volatile memory	4-20
Trace Math Operations	4-20
Data from Channel 1 and Data from Channel 2	4-22
Domain	4-23
Automatic Memory of Domain Settings	4-24
Applicable Calibration Types for Each Domain Mode	4-24
Auxiliary Voltage Domain Example	4-24
FORMAT	4-25
Cartesian Formats	4-25
Smith Chart Formats	4-25
Polar Display Formats	4-25

Format Keys Available on the Front Panel	4-25
Markers	4-29
Using the Markers	4-29
Select the Active Marker	4-29
Marker Units	4-30
Continuous and Discrete	4-31
Marker List Displays	4-31
Delta Mode Markers	4-33
Marker Search Modes	4-34
Search Right and Search Left	4-35
Delta Mode Operation	4-36
Marker Familiarization Sequence	4-36
Parameter	4-38
Basic Parameters	4-38
S-Parameter Definitions and Conventions	4-38
Parameter Menu	4-39
User Parameters	4-40
Redefine Parameter	4-41
Redefine Basic Parameters	4-42
Redefine User Parameters	4-44
Measuring Power (dBm)	4-44
Dynamic Range Considerations	4-46
Response	4-48
Changing Display Scale and Reference	4-48
Setting Scale and Reference Values Automatically	4-48
Changing Display Scale Manually	4-48
Changing the Position of the Reference Line Manually	4-48
Changing the Value of the Reference Line Manually	4-49
Automatic Recall of Previous Display Settings	4-49
Hierarchy of the Automatic Memory	4-49
The automatic memory does not include Stimulus settings	4-50
Other options for control of Stimulus settings	4-50
The Effect of Factory Preset on Display Settings	4-50
Response Menu	4-50
Trace Averaging and Smoothing	4-50
Averaging	4-51
Averaging Details	4-51
Notification when averaging is finished	4-51
Averaging Factor Recommendations	4-51
Smoothing	4-52
Electrical Delay	4-53
Using Electrical Delay	4-53
Delay Features	4-53
Coaxial Delay	4-54
Waveguide Delay	4-54
Table Delay	4-54
Selecting Velocity Factor	4-54
Auto Delay	4-54
Phase Offset	4-54
Magnitude Slope and Magnitude Offset	4-55
Stimulus	4-56

Set Frequency Sweep	4-56
Set Sweep Using Markers	4-57
Set Stimulus Power	4-57
Setting and Monitoring Signal Levels	4-57
Set Source RF Output Level	4-58
Power Slope On/Off	4-59
Attenuator Port: 1 and Attenuator Port: 2	4-59
Setting power for passive devices, or devices with gain	4-59
Source Power and Flatness Correction Calibration	4-60
Selecting the Number of Points to Measure	4-61
Source Sweep Modes	4-62
Speed of Step and Frequency vs. Ramp Modes	4-63
Measurement Hint	4-63
Entering Ramp, Step, and Single Point Stimulus Values	4-63
Sweep Time	4-64
Example: Effects of Sweep Time	4-64
Sweep Execution, Hold/Single/Number of Groups/Continual	4-65
Why Use Number of Groups?	4-66
Coupled/Uncoupled Channels	4-66
How to tell if a function is coupled	4-67
Dual Channel	4-67
Uncoupled Stimulus Settings and Dual Channel Displays	4-67
Trigger Modes	4-68
Creating a Frequency List	4-69
Entering the First Segment	4-69
Add Segments	4-70
Editing the Frequency List	4-70
Changing a Segment	4-70
Deleting a Segment	4-71
Adding a Segment	4-71
To Duplicate Points	4-71
Frequency List Save and Recall	4-71
Selecting All Segments or a Single Segment	4-71
To Exit Frequency List	4-72

5. Using System Functions

Chapter Contents	5-1
System Menus	5-2
Controls that Affect the Network Analyzer	5-3
Phaselock Controls	5-3
Lock Type	5-3
Step Type	5-3
Normal Step	5-4
Quick Step Mode	5-4
Lock Speed	5-4
Warning Beeper	5-5
IF Calibration and Correction	5-5
IF Calibration Controls	5-5
Display Functions	5-5
Creating a Title	5-5
Deleting a Title	5-6

Adjusting the Date/Time Clock	5-6
Using Security Features in the System DISPLAY FUNCTIONS Menu	5-7
Controls that Affect Input/Output	5-8
GPIB Addresses	5-8
GPIB Configure	5-9
Edit Multiple Source	5-9
Power Leveling	5-9
Controlling Multiple Sources	5-11
Using the Multiple Source Menu	5-12
How to Enter the Example Configuration	5-13
Now save the configuration	5-14
Millimeter Wave Mixers	5-15
Uses for the SOURCE 1 and RECEIVER Formulas	5-15
SOURCE 1 Formula Use	5-15
Receiver Formula Use	5-15
Why are these settings used?	5-16
Service Functions	5-18
Test Menu	5-18
Disc Commands	5-19
System Bus Softkeys	5-19
IF Gain	5-20
Why Use Manual Control	5-20
Why the problem occurs	5-20
How to Use Manual IF Gain Controls Properly	5-22
Peek and Poke	5-23
Purpose of Peek and Poke	5-23

6. COPY Printing and Plotting

Chapter Contents	6-1
Installation Considerations	6-2
Supported Interfaces	6-2
Connecting a GPIB Printer or Plotter	6-2
Connecting an RS-232 Printer or Plotter	6-2
Selecting the GPIB (System Bus) or RS-232 Ports	6-2
RS-232 Print/Plot Buffers	6-3
Adding Custom Annotations to the Screen	6-3
Using a Printer	6-4
Printing Features	6-4
What Is Printed?	6-4
Installing a Printer	6-4
Selecting the Output Port	6-4
Printer and the 8510C Configuration	6-5
Using a Laser Printer	6-6
Configuring the Laser Printer	6-6
Using the Standard Configuration	6-6
Using Other Laser Printer Settings	6-6
Configuring the Network Analyzer	6-6
Selecting Printer Resolution	6-6
Using the High Speed Configuration	6-7
Why is it faster?	6-7

My printer has built-in HP-GL. Do I still need the cartridge?	6-7
Ordering the Cartridge	6-7
Having Enough Printer Memory	6-8
Setting the Printer Up	6-8
Using Other Laser Printer Settings	6-8
Configuring the Network Analyzer	6-8
Switching Between Real Plotters and HP-GL-emulating Laser Printers	6-9
Using an HP DeskJet, DeskJet Plus, or DeskJet 500 or 550 Series Printer	6-10
Using Serial Setup	6-10
Setting the Serial DIP Switch	6-10
Preparing the Printer for Use	6-10
Configuring the Network Analyzer	6-10
Selecting Printer Resolution	6-10
Using the HP DeskJet 500C or 550C Additional Steps Required	6-10
Using an HP QuietJet, QuietJet Plus, PaintJet, or PaintJet XL Printer	6-11
Using Serial Setup	6-11
Setting the Serial DIP Switch	6-11
Setting Up GPIB	6-12
Setting the GPIB Address DIP Switch	6-12
Preparing the Printer for Use	6-12
Configuring the Network Analyzer	6-12
Selecting Printer Resolution (HP QuietJet and QuietJet Plus Printers)	6-12
Selecting Printer Resolution (HP PaintJet and PaintJet XL Printers)	6-13
Printing In Color	6-13
Using an HP ThinkJet Printer	6-13
Using Serial Setup	6-13
Setting the Serial DIP Switch	6-13
Setting Up for GPIB	6-13
Setting the GPIB Address DIP Switch	6-13
Preparing the Printer for Use	6-14
Configuring the Network Analyzer	6-14
Selecting Printer Resolution	6-14
Using Non-HP Printers	6-15
Using Serial Setup	6-15
Setting the Serial DIP Switch	6-15
Setting Up for GPIB	6-15
Setting the GPIB Address DIP Switch	6-15
Pre-Printing Check-Out	6-15
Printing	6-16
Printing Orientation: Either Landscape or Portrait	6-16
Printing One Snapshot per Page (Portrait or Landscape)	6-17
Printing Two Snapshots per Page	6-17
Printing Tabular Measurement Data	6-18
Changing the Tabular Data Format	6-19
Printing Instrument Settings and System Configuration	6-20
Using a Plotter	6-22
Plotting Features	6-22
What Is Plotted?	6-22
Installing a Plotter	6-22
Selecting the Output Port	6-22
Connecting the HP 7550, Special Instructions	6-23

Using HP 7550B and HP 7550 Plus Plotters	6-23
Plotting Options	6-23
Selecting Plotter Pen Color	6-23
Plotting with a Single Pen Color	6-24
Plotting	6-25
Plotting One Snapshot per Page	6-26
Plotting Individual Display Components	6-26
Plotting a Selected Quadrant Four Snapshots per Page	6-26
7. Disk Drive Operation	
Features	7-1
Compatible Disk Types, Disk Storage Capacity	7-1
DOS Subdirectories	7-2
Disk Menu	7-2
ASCII and Binary File Types	7-2
Changing between DOS and LIF Discs	7-3
Initializing Discs	7-3
Storing Disk Files	7-4
Loading Disk Files	7-6
Loading a File	7-7
Viewing a Directory of Files	7-7
Deleting Disk Files	7-8
Un-Deleting Disk Files	7-8
Using an External Disk Drive	7-8
Compatible Disk Drives	7-8
Disk Unit Number and Disk Volume	7-8
Connections and Configuration Settings	7-8
Initializing a Hard Disc	7-9
Guide to Saving Data	7-10
Sharing a System	7-11
Saving Everything	7-11
Viewing or Plotting Old Data	7-12
8. Calibrating for System Measurements	
What Is a Measurement Calibration?	8-1
What Is Vector Accuracy Enhancement?	8-1
How the 8510 Corrects Measurement Data	8-2
Calibration Requirements	8-2
Use the Same Stimulus and Parameter Settings in the Measurement	8-2
Settings that should not be changed	8-2
Use the Same Equipment Setup in the Measurement	8-3
Averaging	8-3
Coupled/Uncoupled Channels	8-3
Cal Menu	8-4
Turning On an Existing Cal Set	8-4
Performing a Measurement Calibration	8-5
Calibration Process Synopsis	8-5
Exiting and Resuming a Calibration Procedure	8-5
Time Low Pass Frequencies	8-6
Step 1. Select a Calibration Kit	8-6
What is a “Class” and what is a “Standard?”	8-6

Step 2. Select the Type of Cal You Need	8-6
What a Response Calibration Provides	8-7
What a Response and Isolation Calibration Provides	8-7
What a 1-Port Calibration Provides	8-7
What a Full 2-Port Calibration Provides	8-7
8510 Measurement Specifications and Calibration	8-7
Non-Insertable Devices	8-7
Step 3. Measure all Required Standards	8-9
Connecting Standards	8-9
When You Are Finished Connecting Standards	8-9
If you are using averaging	8-9
Standards Required for a Response Calibration	8-9
Standards Required for a S_{11} 1-Port Calibration	8-10
Standards Required for a Full 2-Port Calibration	8-12
Measurement order is not important	8-12
Standards Required for a TRL 2-Port Calibration	8-14
Step 4. Saving the Cal Set to Memory	8-14
Calibration Save Registers and Storage Capacity	8-14
How to tell if a register already has a Cal Set in it.	8-14
What to do if all registers are full	8-15
Cal Set Limited Instrument State	8-15
S-Parameter Test Set (Two-Path) Calibration Error Models	8-15
Frequency Response Calibrations	8-16
One-Port Device: S_{11} Frequency Response Calibration	8-16
Two-Port Device: S_{11} Frequency Response Calibration	8-17
Two-Port Device: S_{21} Frequency Response Calibration	8-17
Two-Port Device: S_{12} Frequency Response Calibration	8-17
Two-Port Device: S_{22} Frequency Response Calibration	8-18
Response and Isolation Calibration	8-18
1-Port Calibration	8-19
One-Port Device: S_{11} 1-Port Correction	8-19
One-Port Device: S_{22} 1-Port Correction	8-20
Two-Port Device: Combining Error Models	8-20
Full 2-Port Calibration	8-22
TRL 2-Port Calibration	8-24
R/T Test Set (One-Path) Calibration Error Models	8-25
Response and 1-Port	8-25
One-Path 2-Port	8-25
Storing Calibration Data to Disc	8-27
Principles and Care of Calibration Standards	8-27
Calibration Standards Require Careful Handling	8-27
Proper Inspection, Cleaning, and Connection	8-27
Principles of Operation	8-27
Quality of the Standards Affects Accuracy	8-28
Standard Models Differ Depending on Connector Type	8-28
Specifications, Modifying a Cal Kit	8-28
Common Problems	8-28
Verifying Calibration Data	8-29
Adjusting Trim Sweep	8-29
Using Agilent 834x Series Sources	8-30
Using 835x Series Sources	8-30

Modifying a Calibration Kit	8-31
Modifying a Calibration Set	8-32
Reducing the Number of Points After Calibration	8-32
Effects in Step Sweep Mode	8-33
Effects in Ramp Sweep Mode	8-33
Defining a Frequency Subset	8-34
Create and Save the Frequency Subset	8-34
Effects in Ramp Sweep Mode	8-35
Changing the Calibration Type	8-36
Modifying a Cal Set with Connector Compensation	8-36
Using Connector Compensation	8-38

9. Transmission Measurements

Introduction	9-1
Measuring Two-Port Devices	9-1
Using Test Sets	9-2
Setting Up for Transmission Tests	9-3
Transmission Measurement Calibration Choices	9-3
Setting up for Response Calibration	9-4
Response and Isolation Calibration	9-4
One-Path 2-Port Calibration	9-4
Full 2-Port and TRL Calibrations	9-4
Measurement Calibration for Noninsertable Devices	9-4
Making an Adapter Removal Measurement	9-5
Insertion Loss/Gain Measurement	9-6
Measuring 3 dB Frequencies	9-6
Measuring Maximum and Minimum Values	9-7
Making Insertion Phase Measurement	9-8
Measuring S-Parameters	9-9
Making Group Delay Measurements	9-10
Measuring Group Delay Aperture	9-11
Comparing aperture, resolution, and noise	9-12
Measuring aperture and phase slope	9-12
Using aperture and smoothing	9-12
Measuring Deviation from Linear Phase Measurement	9-12

10. Reflection Measurements

Introduction	10-1
Reflection Test Setups	10-1
One-Port Devices	10-1
Two-Port Devices	10-1
Reflection Measurement Calibration Choices	10-1
Response and Response-and-Isolation Calibrations	10-1
1-Port Calibration	10-1
One-Path 2-Port Calibration	10-2
2-Port Calibrations	10-2
Return Loss Measurement	10-3
SWR Measurement	10-3
S-Parameter Measurement	10-4
Impedance Measurement	10-5
Admittance Measurement	10-5

11. Introduction to Time Domain Measurements	
Introduction	11-1
Using Front Panel Controls in Time Domain Mode	11-1
General Theory	11-1
Time Domain Modes	11-3
Reflection Measurements Using Time Band Pass	11-4
Interpreting the Time Band Pass Reflection Response Horizontal Axis	11-5
Interpreting the Time Band Pass Reflection Response Vertical Axis	11-5
Fault Location Measurements Using Time Band Pass	11-5
Transmission Measurements Using Time Band Pass	11-6
Interpreting the Time Band Pass Transmission Response Horizontal Axis	11-7
Interpreting the Time Band Pass Transmission Response Vertical Axis	11-7
Time Domain Low Pass	11-8
Low Pass Mode Requirements	11-8
Setting Frequency Range for Time Low Pass	11-8
Avoiding Noise	11-9
Analyzing Time Low Pass Reflections	11-9
Reflection Measurements using Time Low Pass	11-9
Interpreting the Time Low Pass Reflection Response Horizontal Axis	11-10
Interpreting the Time Low Pass Reflection Response Vertical Axis	11-10
Trace Bounce	11-12
Time Domain Concepts	11-14
Masking	11-14
Windowing	11-15
Range	11-17
Resolution	11-18
Response Resolution	11-18
Range Resolution	11-19
Gating	11-19
Setting the Gate	11-20
Select Gate Shape	11-21
Measurement Recommendations	11-22
Source Considerations	11-23
Test Set Considerations	11-23
12. Power Domain Measurements	
Introduction	12-1
What Is Power Domain?	12-1
What Is Receiver Cal?	12-2
Making a Power Domain Measurement	12-3
Performing a Receiver Calibration	12-4
The Flatness Calibration Must Be Completed	12-4
Swept-Frequency Gain Compression Measurement Exercise	12-6
Swept-Power Gain Compression Measurement Exercise	12-7

13. GPIB Programming

What's in This Chapter	13-1
What You Can Do with Remote Programming	13-2
GPIB Command Information	13-2
Programming Command Sequence	13-2
Syntax Requirements	13-2
Entering Mnemonics	13-2
Using Numeric Entries and Units	13-3
"Next Menu" Commands Are Unnecessary	13-3
Timing Considerations	13-3
Overview of Computer-Controlled Measurements	13-4
Setting Up the System	13-4
Connect the External Computer	13-4
Address Settings	13-4
Set Up the Measurement Using GPIB Commands	13-5
Transferring Data out of the Network Analyzer	13-5
Sending Data to the Computer	13-5
What Types of Data Are Available from the 8510C?	13-5
Data Arrays Read by an External Computer	13-6
Raw Data	13-6
Corrected Data Array	13-6
Formatted Data Array	13-7
Data Always Comes from the Active Channel	13-8
Available Data Transfer Formats	13-8
How Much Data Is Transferred?	13-9
Preparing the Computer to Transmit or Receive Data	13-9
Setting up the I/O Path	13-9
Size of the Preamble, Size Block, and Data Blocks	13-10
Setting Up Variables	13-10
Dynamic Array Allocation	13-10
Performing the Actual Transfer	13-11
An Example of a Data Transfer	13-11
Using the Data	13-13
Preprocessing FORM1 Data	13-13
Using Real/Imaginary Format for Vector Math	13-13
Converting Real/Imaginary Data to Magnitude and Phase Data	13-13
Transferring Data into the Network Analyzer	13-14
Raw, Corrected, Formatted Arrays	13-14
Trace Memories	13-15
FORM4 Input	13-15
Commonly-Used Queries	13-16
Marker Value	13-16
Active Function Value	13-16
Query System State	13-16
System Status	13-16
Where to Find Other Query Commands	13-17
Local Operation	13-17
Program Debugging Aids	13-17
Programming Examples	13-18
Example 1: Syntax Familiarization	13-18
Example 2: Active Function Output	13-19

Example 3: Marker Output	13-20
Example 4: Marker Operations	13-21
Example 5: Single- and Dual-Channel Displays	13-22
Example 6: Trace Data Output/Input	13-22
Example 7: FORM1 Data Conversion	13-22
Example 8: S11 1-Port and S21 Response Cals	13-22
Selecting the Calibration Type	13-22
Select the Standard Class	13-23
Select Calibration Standards in Class	13-24
Save the Cal Set	13-24
Example 9: Modify Cal Kit	13-25
Example 10: Simulated Standard Measurement	13-25
Example 11: Using the Drive Disk	13-25
Using the Internal Disk	13-25
File Name Prefixes	13-26
Printing Your Own Messages on the Network Analyzer Display	13-26
Example 12: Making Plots Using COPY	13-26
Example 13: List Trace Values	13-27
Example 14: Print to Printer on 8510C System Bus	13-27
General Input/Output	13-27
Passing Commands through the Network Analyzer Devices on the System Bus	13-27
How to send pass-through commands	13-27
How pass-through works	13-28
Pass-Through to a Printer	13-29
Output to a Plotter	13-29
User Display Graphics	13-29
Example 15: Plot User Graphics	13-29
Example 16: Plot Using BASIC HP-GL	13-29
Vector Diagrams	13-29
Text	13-30
Select Pen Colors	13-31
Using the Internal Disk to Store the User Display	13-31
Summary of User Graphics Statements	13-31
Summary of User Display Instructions	13-32
Example 17: Redefine Parameter	13-32
Example 18: Read and Output Caution/Tell Message	13-32
Example 19: Read and Output Status Bytes	13-32
Read Status Bytes	13-33
Setting the Service Request Mask	13-33
Example 20: Output Key Code	13-34
Example 21: Triggered Data Acquisition	13-34
Example 22: Wait Required	13-34
Example 23: Wait Not Required	13-34
Example 24: Frequency List	13-34
Example 25: Output/Learn String	13-35
Example 26: Input and Display ASCII Trace	13-35
Example 27: Delay Table Operations	13-36
Example 28: Fast CW Data Acquisition	13-36
Example 29: Test Port Power Flatness Cal	13-36
Example 30: Receiver Power Cal/Power Domain	13-36

Example 31: Disk Store and Load Using Cal Sets	13-37
General GPIB Programming	13-38
Interface Functions	13-38
Response to GPIB Universal Commands	13-39
Response to GPIB Addressed Commands	13-39
Example Program Listing	13-40
Example Programs in EX_8510	13-40

14. Operator's Check and Routine Maintenance

Operator's Check	1
Agilent 8510 Self-Test	1
S-Parameter Test Set Check	2
In Case of Difficulty	2
Routine Maintenance	3
Maintain Proper Air Flow	3
Inspect and Clean Connectors	3
Cleaning the Test Set Rear-Panel Extensions	4
Cleaning the Glass Filter and CRT	4
Cleaning the LCD	5
Deguass (Demagnetize) the Display (CRT Only)	5
Inspect the Error Terms	5

Index

Figures

1-1. Typical 8510 Network Analyzer System	1-2
1-2. 8510C Network Analyzer Front-Panel Key Blocks	1-3
1-3. Annotation Areas for Single Parameter, or Dual Channel Display Mode	1-4
1-4. ENTRY Block Keys	1-7
1-5. Channel 1 and Channel 2 Selection Keys	1-9
1-6. Uncoupled Channels Showing Alternate Frequency Sweep	1-9
1-7. Stimulus, Parameter, Format, and Response Keys	1-11
1-8. Measurement RESTART Key	1-12
1-9. INSTRUMENT STATE Block	1-15
2-1. Network Analyzer System Interconnections	2-2
2-2. Measurement Sequence 1, Test Setup	2-5
2-3. Initial Display Showing a Thru Connection	2-6
2-4. Display with Open Circuit Connected	2-9
2-5. Display with S_{11} Response Calibration ON	2-9
2-6. Display with Thru Connected (S_{21} Calibration)	2-9
2-7. Display with S_{21} Response Calibration ON	2-9
2-8. Return Loss: S_{11} LOG MAG	2-10
2-9. Insertion Loss: S_{21} LOG MAG	2-10
2-10. Time Domain Refl Response Short Circuit: S_{11} TIME BANDPASS	2-13
2-11. Time Domain Reflection Response of an Air Line and Short Circuit	2-14
2-12. Time Domain Reflection Response of a Thru: S_{21}	2-15
2-13. Time Domain Reflection Response of an Air Line: S_{21}	2-15
3-1. Reflection and Transmission Measurements Diagramed	3-2
3-2. Simplified System Block Diagram	3-3
3-3. Digital Signal Processing	3-6
3-4. Reflection/Transmission Test Set Signal Flow	3-8
3-5. S-Parameter Test Set Signal Flow	3-9
3-6. 8511A Frequency Converter Signal Flow	3-10
3-7. Recommended Typical Test Setups	3-12
4-1. Display and Display Mode Menus	4-2
4-2. Annotation Areas for Single Parameter or Dual Channel Display Mode	4-2
4-3. Annotation Areas for Four Parameter Split Display Mode	4-3
4-4. Dual Channel Overlay and Split Displays	4-4
4-5. Adjust Display Menu	4-7
4-6. External Video Menu	4-9
4-7. Example of a Limit Test using Limit Lines	4-12
4-8. Limit Test Example Using Limit Lines and Limit Points	4-16
4-9. Display Menu Showing Trace Memory Locations Menu	4-19
4-10. Trace Math Operations Menu Structure	4-21
4-11. Domain Main Menu Structure	4-23
4-12. Format Function Block and Format Menu	4-26
4-13. Format Selections (1 of 2)	4-27

4-14. Format Selections (2 of 2)	4-28
4-15. MARKER Key and Marker Menus	4-29
4-16. Markers on Trace	4-30
4-17. Marker and Δ Mode Menus	4-33
4-18. Δ Mode Markers on Trace	4-34
4-19. Marker Search Modes	4-35
4-20. Δ Mode Marker to Target	4-36
4-21. Parameter Function Block	4-38
4-22. S-Parameter Flowgraphs	4-39
4-23. Parameter Menu	4-40
4-24. Typical User 1, a_1 Measurement	4-40
4-25. Redefine Parameter Menu Structure	4-43
4-26. Dynamic Range Considerations	4-47
4-27. Response Function Block	4-48
4-28. Response Menu Structure	4-50
4-29. Results of Averaging	4-52
4-30. Smoothing Operation	4-52
4-31. Results of Smoothing	4-53
4-32. STIMULUS Function Block	4-56
4-33. Source Power Menu	4-58
4-34. Number of Points Menu	4-61
4-35. Narrowband Responses	4-62
4-36. Sweep Mode Menu	4-63
4-37. Effects of Sweep Time	4-65
4-38. Hold, Single, Number of Groups, Continual	4-65
4-39. Trigger Mode Menu	4-68
4-40. Frequency List Menu Structure	4-69
4-41. Enter the First Segment	4-70
4-42. Frequency List, Display of Single Segment	4-72
5-1. Main System Menu and Part of the Display Functions Menu	5-2
5-2. System Phaselock Menu	5-3
5-3. Date/Time Functions Menu	5-6
5-4. System Power Leveling Menu	5-10
5-5. Actual LO Frequency Required by a Harmonic Mixer	5-11
5-6. Edit Multiple Source Menu	5-12
5-7. Source 2 Modified for Third Harmonic Mixer System	5-13
5-8. Finished Multi-Source Configuration, LO Source and 3rd Harmonic Mixers	5-14
5-9. Module Testing Example	5-16
5-10. Finished Multiple Source Configuration for Hypothetical Module	5-17
5-11. Service Functions Menu	5-18
5-12. Simplified Block Diagram of the Agilent 8510C Network Analyzer	5-21
5-13. Gain Stages in the IF section	5-22
6-1. Define Print Menu	6-5
6-2. HP QuietJet and PaintJet (Family) Printer Serial Switch Settings	6-11
6-3. HP QuietJet and PaintJet (Family) Printer GPIB Switch Settings	6-12
6-4. HP ThinkJet Printer GPIB Switch Settings	6-14
6-5. Landscape Printer Orientation	6-16
6-6. Portrait Printer Orientation	6-17
6-7. Define List Menu	6-19
6-8. System/Operating Parameters Menu	6-20
6-9. Define Plot and Plot to Plotter Menu Structure	6-25

6-10. Four-Quadrant Plot Example	6-27
7-1. Disk Menu, Data Type Select Menu, Setup Disk Menu, and Initialize Disk Menu	7-2
8-1. Cal and Cal Type Menus	8-4
8-2. Cal Type Selections	8-8
8-3. Response Cal Menu	8-10
8-4. S_{11} 1-Port Cal Menu	8-11
8-5. LOADS Frequency Ranges	8-12
8-6. Full 2-Port Reflection, Transmission, and Isolation Cal Menus	8-13
8-7. TRL 2-Port Cal Menu	8-14
8-8. S-Parameter Test Set Frequency Response Calibrations	8-16
8-9. S-Parameter Test Set 1-Port Calibrations	8-19
8-10. S-Parameter Test Set Full 2-Port Calibration	8-22
8-11. Reflection/Transmission Test Set One-Path 2-Port Calibration	8-26
8-12. Reduced Number of Points After Calibration	8-33
8-13. Modify Cal Set, Frequency Subset Menu	8-34
8-14. Defining a Frequency Subset	8-35
8-15. Connector Compensation Menu Keys	8-37
9-1. Two-Port Device Types	9-1
9-2. Transmission Test Setups	9-3
9-3. Adapter Removal Calibration Sequence	9-5
9-4. Typical Insertion Loss Display	9-6
9-5. Measuring 3 dB Points	9-7
9-6. Measuring Minimum and Maximum Insertion Loss	9-8
9-7. Typical Insertion Phase Display	9-9
9-8. Typical S-Parameter Display	9-9
9-9. Group Delay Definition	9-10
9-10. Group Delay Aperture	9-10
9-11. Typical Group Delay Display	9-11
9-12. Changing the Group Delay Measurement Aperture	9-11
9-13. Group Delay Plots with Different Aperture Selections	9-12
9-14. Typical Group Delay and Deviation from Ideal Phase Displays	9-14
10-1. Typical Measurement Setup	10-2
10-2. Typical Return Loss Display	10-3
10-3. Typical SWR Display	10-4
10-4. Typical S-Parameter Display	10-4
10-5. Typical Impedance Display	10-5
10-6. Typical Admittance Display	10-5
11-1. Frequency Domain and Time Domain Measurements	11-2
11-2. Measurement of a Sliding Load	11-4
11-3. Cable Fault Location Measurement Using Time Band Pass	11-6
11-4. Transmission Measurement in Time Band Pass	11-7
11-5. Time Low Pass Step and Impulse Responses	11-11
11-6. Time Low Pass Step Response of a 25 Ω Airline and Fixed Load	11-12
11-7. Step Response of a 30 cm Airline and Fixed Load	11-13
11-8. Masking Example: 3 dB Pad and Short Circuit	11-14
11-9. Time Domain Window Characteristics	11-16
11-10. Approximate Formulas for Step Rise Time and Impulse Width	11-16
11-11. Effect of Windowing on Time Domain Responses of a Short Circuit	11-17
11-12. Time Domain Measurement Showing Response Repetitions	11-18
11-13. Resolution in Time Domain	11-19

11-14. Typical Gate Shape	11-20
11-15. Reflection Measurement of 7-mm to 3.5-mm Adapter, Airline, and Load . .	11-20
11-16. Gated Responses of the 7-mm to 3.5-mm Adapter	11-21
11-17. Gate Characteristics	11-22
12-1. Domain Menu with Power Domain Function Keys	12-1
12-2. Receiver Calibration Menu	12-2
13-1. Data Processing Stages in the Network Analyzer	13-6
13-2. PA Vector Scaling	13-30
13-3. Text Character Cell	13-31
14-1. Typical Preset State Display	1
14-2. Removing the Glass Filter	4
14-3. Motion for Degaussing the Display	5

Tables

0-1. Contacting Agilent	v
1-1. ENTRY Key Terminator Definitions	1-8
2-1. To Match Pen Colors to Display Default Colors	2-12
2-2. Plot Category Key Choices	2-12
3-1. Factory Preset Conditions for the 8510C	3-16
3-2.	3-17
4-1. Default Settings for Display Elements	4-8
4-2. External Display Cable Connections	4-10
4-3. Marker Units	4-31
4-4. Standard PARAMETER Definitions	4-41
4-5. Measuring Power (dBm) at First Frequency Converter	4-45
4-6. Approximate Insertion Losses in Test Sets (dB)	4-45
4-7. Approximate Insertion Losses in Test Sets (dB)	4-46
4-8. Typical Test Port Power Ranges for Source or Test Set Configurations	4-60
5-1. Test Menu	5-19
6-1. Serial Printer Settings for Other Printers	6-15
6-2. Default Pen Numbers	6-24
7-1. Disk Storage Capacities	7-1
7-2. Information You Can Store to Disc, and How it Is Saved	7-3
7-3. File Types and Prefixes	7-7
11-1. Useful Time Band Pass Formats	11-5
11-2. Maximum Frequency Ranges for Time Low Pass	11-8
11-3. Useful Time Low Pass Formats	11-12
13-1. Marker Units for All display Formats	13-20

Introduction to the 8510C Network Analyzer System

Introduction

Vector network analyzer systems, such as the Agilent 8510, measure the magnitude and phase characteristics of networks and of components such as filters, amplifiers, attenuators, and antennas. This chapter describes the system, how to use the front panel controls, and explains the following:

- system components
- display and its annotations
- various front panel keys (hardkeys)
- menus and related softkeys used in the 8510 network analyzer system

8510 Network Analyzer System Description

The 8510 Network Analyzer is a fully integrated vector network analyzer system. The minimum configuration consists of a source, a test set, and the network analyzer. Shown in Figure 1-1 are the three major instruments of the basic system:

Source	The source provides the RF signal. An Agilent 8360 Series synthesized sweeper, or an 834x Series synthesized sweeper, or an 835x-Series sweep oscillator with an appropriate Agilent 835xx Series plug-in, may be used.
Test Set	The test set separates the signal produced by the source into an incident signal, sent to the device-under-test (DUT), and a reference signal against which the transmitted and reflected signals are later compared. The test set also routes the transmitted and reflected signals from the DUT to the receiver (IF/detector). Any 851x Series test set may be used.
Network Analyzer	An 8510C network analyzer, which includes, the Agilent 85101 Display/Processor and the 85102 IF/Detector (Receiver). The receiver, together with the display/processor, processes the signals. Using its integral microprocessor, it performs accuracy enhancement and displays the results in a variety of formats.
Peripherals	Additional system components can include GPIB peripheral devices such as a printer, a plotter, and a disc drive. Measurement results and other kinds of information can be sent to a printer or plotter, or to a disc drive. These system instruments are controlled with network analyzer front panel keys.

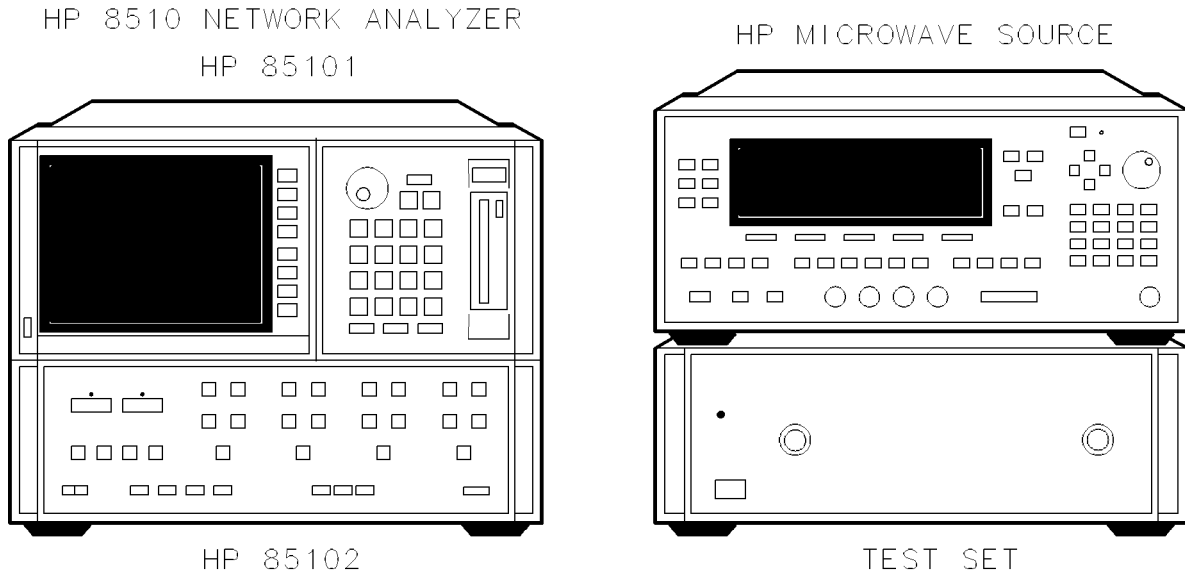

Figure 1-1. Typical 8510 Network Analyzer System

Front Panel Controls

The keys that control the features of the network analyzer system are described in this section. Front panel controls of the 8510 system are grouped in blocks and labeled as shown in Figure 1-2. The only test set front panel control is the line switch, and if a switchable test set is used, there are indicators showing the current signal path selection. The source is controlled by the 8510 system bus, not from its own independent front panel.

Procedures in this section assume that the network analyzer system is installed properly. If the system is not installed, refer to Chapter 9, "System Installation" in the *Agilent 8510C On-Site Service Manual* for instructions.

The section is organized in left to right-hand order, as listed below:

- Display Modes and Annotation Areas
- ENTRY Block
- ACTIVE CHANNEL Block
- MENUS Block
- STIMULUS/PARAMETER/FORMAT/and RESPONSE Blocks
- INSTRUMENT STATE Keys
- AUXILIARY MODE Keys
- MEASUREMENT Key

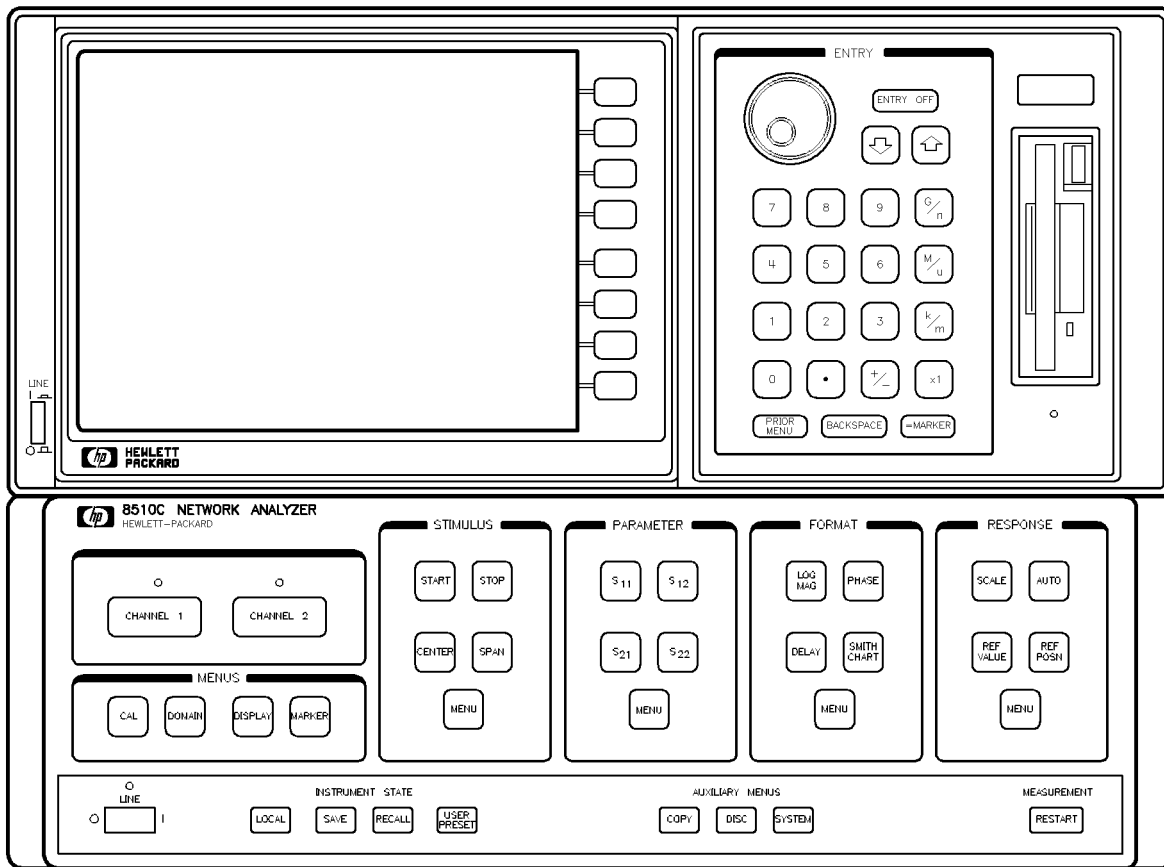

Figure 1-2. 8510C Network Analyzer Front-Panel Key Blocks

Display Modes and Annotation Areas

Note The original 85101C (top box) incorporated a cathode ray tube (CRT) based display. The current design incorporates a liquid crystal display (LCD). In this manual, references to either CRT or LCD apply to both display designs unless noted otherwise.

Information can be displayed in several ways on the network analyzer display and the screen annotation areas are dependent on the display mode. See Figure 1-3 for an example of one display with its annotation areas. The available display modes are listed below:

- single channel, single parameter
- single channel, four parameter overlay or split
- or dual channel overlay or split

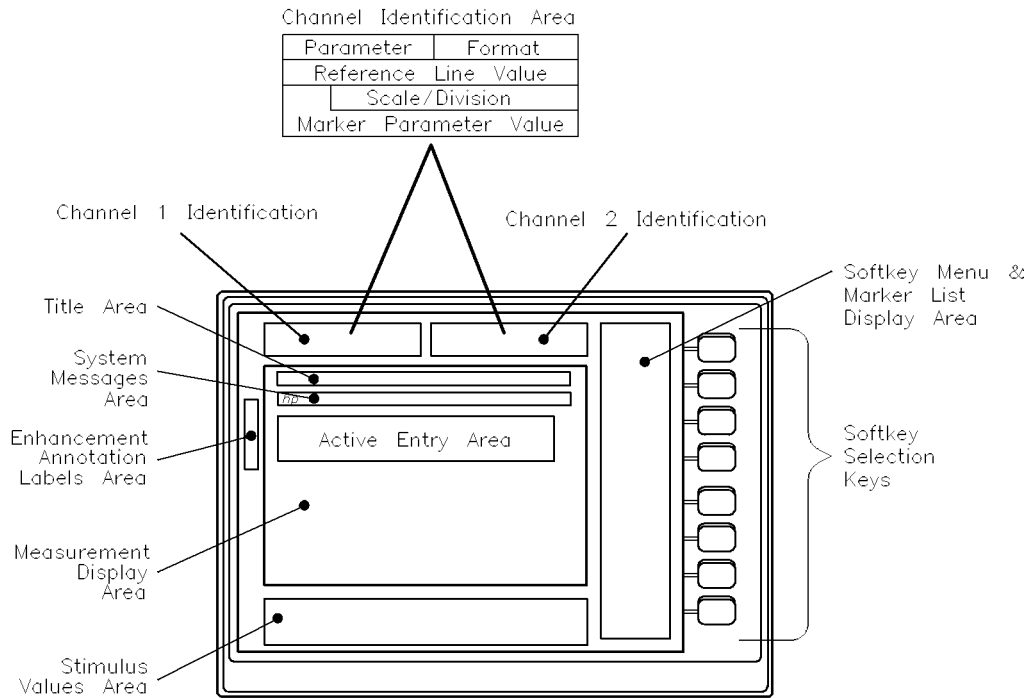

Figure 1-3. Annotation Areas for Single Parameter, or Dual Channel Display Mode

For simplicity, only one type of display mode is discussed here. If you need information about the various display modes, refer to the section titled “Display” in Chapter 4 of this manual.

Channel/Parameter Identification Area

Measurement information appears at the top of the display for this display mode. The parameter information, display format, reference line value(s), and the scale/division are shown. Color matches the identification labels to the trace display. The active parameter is indicated by a “▶” symbol, and the color of the stimulus values (at the bottom of display) match the color of the active parameter.

In the Single Parameter and Dual Channel display modes, Channel 1 information appears on the left and Channel 2 information appears on the right.

Stimulus Values Area

The current start/stop, center/span, or single point stimulus settings appear along the bottom of the display, and match the color of the active channel/parameter to emphasize the channel/parameter you are controlling.

Active Entry Area

The active entry area of the display identifies the current active function for the selected channel/parameter, and matches the color of the active channel/parameter to emphasize the channel/parameter you are controlling. Press **ENTRY OFF** to clear this area.

Knowing When a Function Is Selected

If the function sets a value only, then the current value is displayed in the active entry area when the function is activated. Use the RPG knob, arrow keys, numeric, units, and **MARKER** keys (in the ENTRY block) to enter values. Other functions indicate the value or choice currently selected with an underline.

Recognizing Mutually-Exclusive Functions

Mutually exclusive functions are indicated by vertical lines connecting them. They are individual choices available for one specific operation, as listed below:

```
SWR
|
LINEAR
```

Title Area

The title area provides a space to enter up to 50 characters of information about the measurement. Notice that the location of this area depends on the display mode. An example of how to create a title is given in this chapter in later paragraphs.

System Messages Area

Prompts, error messages, and procedural advisories appear in the system messages area located below the Channel 1 identification labels.

If an error that affects the measurement occurs, a message is displayed and a “beep” may signal you to look at the message. The message remains displayed until:

- It is replaced by another system message.
- You press a function key such as **START** or **USER PRESET**.
- You manually clear the message by pressing **ENTRY OFF** (located above the knob).

Enhancement Annotation Area

Along the left side of the screen, certain one-character labels appear when you select network analyzer functions that affect the accuracy or presentation of the measurement trace. These labels are:

- * = Measurement Incomplete
- C = Correction On
- A = Averaging On
- S = Smoothing On
- G = Time Domain Gating On
- D = Electrical Delay, Phase Offset, Magnitude Offset, or Magnitude Slope On
- H = Hold
- O = IF Overload
- M = Multiple Source On

These symbols are present if the given condition exists on any displayed channel/parameter. That is, for dual channel displays, if either channel has smoothing turned on, the “S” is shown.

In four parameter display modes, unless a full 2-port calibration has been performed and is the active correction, the correction-on symbol “C” is not shown, and a system warning message is displayed.

The measurement incomplete symbol “*” is displayed in several situations. After any *measurement restart*, it signifies that the first sweep has not been completed. When this symbol disappears, you can be certain that all basic data acquisition and error correction functions (except possibly averaging) are complete.

Display annotation for Cartesian displays includes Trace labels (1→ for Channel 1, on the left of the graticule and ←2 for Channel 2, on the right), and Reference Line Position symbols (> for Channel 1 on the left and < for Channel 2 on the right).

Softkey Menu and Marker List Display Area

Softkey menus appear in the area on the right side of the display, and beside them are the eight keys used to make menu selections. Menus and how to make selections are discussed later in this chapter.

The softkey menu display area is also used to display marker values and the internal date/time clock of the analyzer. Markers and the date/time clock can only be displayed when menus are not being displayed. The different types of marker displays and the date/time clock are discussed in the section titled “Display” in later chapters. An example of how to change the date/time clock is given in the paragraph titled “Using the Menus, Examples,” in this chapter.

Using ENTRY Block Keys

The ENTRY block contains the RPG knob, the entry off key, numeric keys, units terminator keys, and the arrow keys. Use these keys to enter and terminate values for the function that is currently active. Use the **ENTRY OFF** key to clear the information displayed in active function area.

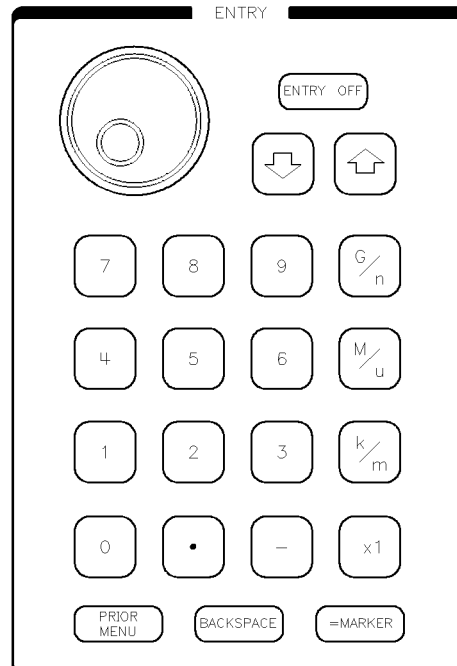

Figure 1-4. ENTRY Block Keys

Uparrow (▲) and Downarrow (▼) Keys

The arrow keys increase or decrease the value of the current active function. The size of the step increment is determined by the current state of the network analyzer and cannot be changed by the operator.

Using Numeric Keys

1. First select the function to change.
2. Press **START**, for example. Its current value is now displayed in the active function area.
3. Rotate the RPG knob to change the value, or press an arrow key to incrementally increase or decrease its value.
4. To enter a specific value, press the numeric keys, **0** through **9**, then one of the units terminator keys to the right of the numbers.
5. The **+/-** (change sign) can be entered before or after the numeric entry.

Using Units Terminator Keys

When a units terminator key is pressed, the instrument state displays the new function value. The value of each terminator key depends on the function that is active. Refer to Table 1-1 for the meaning of each terminator key.

Table 1-1. ENTRY Key Terminator Definitions

Key	Description	Frequency	Time	Power	Power and Magnitude Slope	Voltage
(G/n)	Giga/nano	GHz	ns ¹			
(M/μ)	Mega/micro	MHz	μs			
(k/m)	kilo/milli	KHz	ms			mV
(x1)	basic unit for active function (dB, dBm, Degree, second, Hertz, volt).	Hz	s (second)	dB	dB/GHz	V (volts)

¹ Note that you may enter time in picoseconds by using the decimal point. For example, to enter 10 picoseconds, enter .01 then press **(G/n)**.

Blank entries in Table 1-1 indicate that although the terminator keys for that quantity are defined, the value may not be useful.

Using the Prior Menu Key

Press the front panel key labeled **(PRIOR MENU)** to return to the menu previously displayed. If the menu currently displayed is a main (top-level) menu, pressing **(PRIOR MENU)** clears all key labels from the menu area.

Using the Backspace Key

Use the **(BACKSPACE)** key to correct errors during entry.

Using the **(=MARKER)** Key

Use the **(=MARKER)** key to transfer the current value of a marker to the current active function.

For example, press **(MARKER)** (MENUS block). Use the knob to position the marker to the desired point on the trace. Now press **(REF VALUE)** (RESPONSE block) **(=MARKER)**. Notice that the reference value becomes the marker value and the trace is moved to meet the reference line at the marker point.

Not all active functions can use this feature, only those that are consistent with the marker units.

Using ACTIVE CHANNEL Block Keys

When lit, the LED located above **CHANNEL 1** or **CHANNEL 2** indicates the channel selected. Press either key to choose the channel for measurement control.

The capability of Channel 1 is identical for Channel 2. For most functions, they function completely independently.

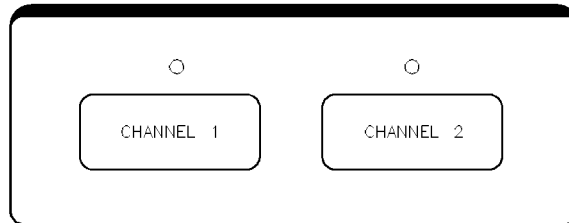

Figure 1-5. Channel 1 and Channel 2 Selection Keys

Coupling Channels

When channels are coupled, the setting for the currently active channel is automatically duplicated into the other channel.

To uncouple the stimulus (and the error correction) functions between the channels, press the STIMULUS block keys: **MENU**, **MORE**, and **UNCOUPLED CHANNELS**.

Now change the STIMULUS controls. Figure 1-6 shows the alternate frequency sweep possible using this feature.

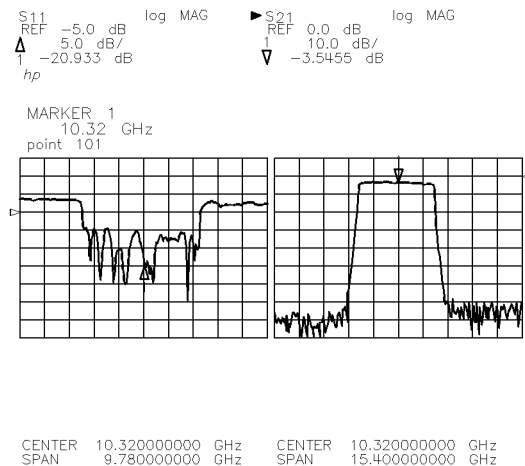

Figure 1-6. Uncoupled Channels Showing Alternate Frequency Sweep

Coupling Conditions

Note Some functions are always the same for each channel, that is, they are *always coupled*. There are also some that are *always uncoupled*; and some that *may be uncoupled*, depending upon your selection of **COUPLED CHANNELS** or **UNCOUPLED CHANNELS**. For more information about coupling, refer Section 4, Stimulus Functions, “Coupled/Uncoupled Channels.”

Using MENUS Block Keys

The 8510 network analyzer system’s extensive series of menus can be selected, modified, and recalled using front panel keys and the eight softkeys (located along the right-hand side of the display).

Refer to the information below for descriptions of the main function block menu keys.

Keys labeled **CAL**, **DOMAIN**, **DISPLAY**, and **MARKER** (located in the MENUS function block) display the sub-menus described below:

CAL Use to remove systematic errors from measurements by calibrating against high-quality reference standards.

DOMAIN Use to select between frequency domain, optional time domain, voltage domain, or power domain measurement modes. In Cartesian formats, the “domain” is in reference to the X-axis value on the display.

- In frequency domain, the X-axis is in frequency units.
- In time domain, the X-axis is time (or distance).
- In voltage domain, the X-axis is in voltage units.
- In power domain, the X-axis is in absolute power units.

DISPLAY Perform dual channel, four parameter, trace memory, limit line operations, and adjust display attributes.

MARKER Perform marker and delta marker functions.

Using STIMULUS, PARAMETER, FORMAT, and RESPONSE Blocks Keys

Keys in these four function blocks control the four basic measurement functions of the 8510 system. A key labeled **MENU** is available in each of the four main function blocks, STIMULUS, PARAMETER, FORMAT, and RESPONSE. Press the respective **MENU** key to display sub-menus for that function.

- | | |
|-----------|---|
| Stimulus | Sets the start and stop frequency in Frequency Domain mode, or start and stop time or length in Time Domain mode. Keys and softkeys in this functional block control the RF source. |
| Parameter | Selects the device under test (DUT) characteristic you wish to observe. Depending on the test set S_{11} , S_{12} , S_{21} , or S_{22} (ratioed measurements) and/or a_1 , a_2 , b_1 , or b_2 (unratioed measurements) can be made. |
| Format | Determines the graphical system is used to display the data. You can choose from many display formats, including Log Mag, Phase, Delay, Polar, Smith Chart Impedance, Admittance, Real, and Imaginary. |
| Response | Primarily sets the display scale and reference points used on the screen. An AUTO function conveniently centers the reference vertically and scales the trace for optimum viewing. |

In general, these controls are independent for channel 1 and channel 2. Each of these front panel “functional blocks” has its own **MENU** key. Press the **MENU** key to display the first-level menu for that functional block.

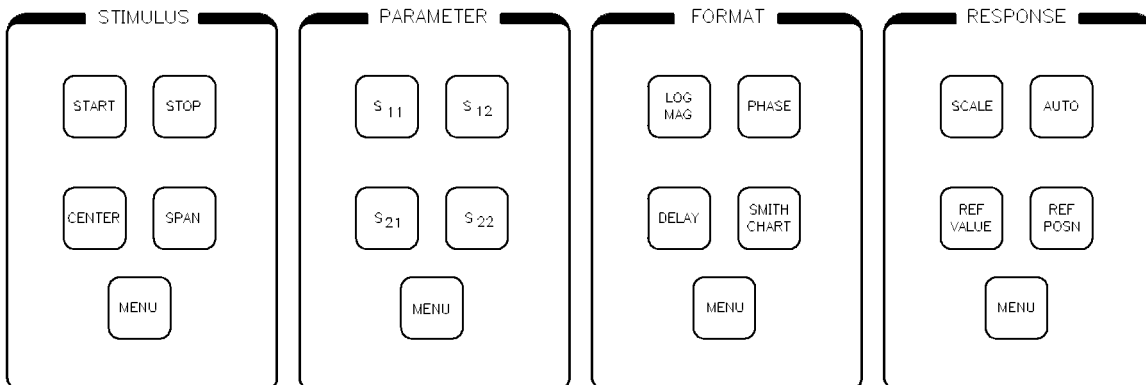

Figure 1-7. Stimulus, Parameter, Format, and Response Keys

In the PARAMETER function block, pressing **S₁₁**, **S₁₂**, **S₂₁**, or **S₂₂** displays the measurement of that parameter. If the network analyzer incorporates an S-parameter test set, the correct signal path for the forward or reverse measurement is automatically selected. Use the FORMAT keys to select the desired grid for display of the measurement. Now use the keys in the RESPONSE block to position the trace on the grid for convenient viewing.

Using INSTRUMENT STATE Keys

Keys labeled **SAVE**, **RECALL**, and **LOCAL** (located in the INSTRUMENT STATE block) display the sub-menus described below:

- SAVE** **RECALL** Save and recall instrument settings (states) and Factory Preset.
- LOCAL** Show all internal and external interface bus addresses.

Using AUXILIARY MODE Keys

Keys labeled **COPY**, **DISC**, and **SYSTEM** (in the front panel area labeled AUXILIARY MENUS) display the sub-menus described below:

- COPY** Printing and plotting functions.
- DISC** Store measurement or calibration data to disc.
- SYSTEM** Perform system-related functions such as defining multiple sources, phase lock reference, and service-related functions.

Using MEASUREMENT Block Key

The MEASUREMENT **RESTART** key (at the bottom-right corner of the front panel) restarts the measurement, including the current group of sweeps, and averaging.

MEASUREMENT

RESTART

Figure 1-8. Measurement RESTART Key

Measurement restart is performed automatically whenever a parameter is changed and in most other instances when the machine state is changed in a way that could affect the measured value, such as turning correction on.

Using the Menus, Examples

You can use the factory preset function to set the system to a known starting point. Refer to the key presses below:

Press **RECALL**.

Press the key next to the **MORE** label displayed on the screen.

Press **FACTORY PRESET**. Notice that all instruments on the System Bus get preset.

To Create, Edit, or Delete a Title

1. To create or change a title, use the keys listed below:
 - a. Press **SYSTEM**, **TITLE** to display the title menu and the current title.
 - b. To enter a character, position the ↑ symbol below the character by rotating the RPG knob.
 - c. Press **SELECT LETTER**. The character appears as the last character in the title area. Repeat this process enter the remainder of the title characters.
 - d. Press **BACK SPACE** to erase the first title character located to the left-hand side of the arrow. When you finish creating or editing the title, select **TITLE DONE**.
2. To completely delete a displayed title, use either of the keys listed below:
 - a. Press the softkey labeled **ERASE TITLE** to completely erase the title.
 - b. Press the ENTRY block **BACKSPACE** key to erase individual title characters.

To Adjust the Date/Time Clock

To adjust the date/time clock annotation, use the keys listed below:

Note You may use the RPG knob, numeric entry keys and a terminator key, or the **▲/▼** arrow keys to select values. Keys used in the following example are for demonstration purposes only. In the same manner, you may adjust the hour and minutes of the date/time clock.

1. Press **SYSTEM**, **DISPLAY FUNCTIONS**, **DATE/TIME FUNCTIONS** to display the adjust main menu.
2. Select **SET YEAR**. The date/time clock appears in the lower right-hand corner of the display. Notice the prompt in the active entry area; adjust the setting by rotating the RPG knob and set the year.
3. Select **SET MONTH**. Press the numeric value corresponding to the number of the month. Press **X1** to terminate the entry. Notice that the month annotation is automatically translated to the three-letter abbreviation of the month.
4. Select **SET DAY**. Use the **▲/▼** arrow keys to set the date.

The Analyzer Remembers Previous Settings (Limited Instrument State)

The analyzer has a system of remembering the settings you use. This allows you to switch between measurements and have the instrument automatically remember all the settings you have previously made. This feature is automatic, in that it does not require you to use a save or recall function.

This ability to remember past settings is called a “limited instrument state,” and works as follows:

Channels 1 and 2 act like separate network analyzers. The analyzer remembers the various settings you make in channel 1. If you change to channel 2, the instrument remembers all the settings (listed below) automatically. When you come back to channel 1, all the settings revert to their original state. Channel 2 works the same way. Each channel remembers all of the settings listed below.

- The selected domain (Frequency Domain, Time Domain or Voltage Domain). In addition, each domain mode remembers all of the following settings.
- The selected measurement parameter (S_{11} , S_{12} , S_{21} , or S_{22}). Each parameter (S_{11} , S_{12} , and so on) also remembers the display format (graph type) and response (scale and reference) settings.

For example, you might want to display S_{11} and S_{22} on a Smith Chart; group delay for S_{21} ; and phase for S_{12} .

To set this up:

1. Press **S11** **SMITH CHART**.
2. Press **S21** **DELAY**.
3. Press **S12** **PHASE**.
4. Press **S22** **SMITH CHART**.

Now, randomly select between S_{11} , S_{12} , S_{21} , and S_{22} . Notice that the analyzer remembers the display format you chose for each one.

As mentioned above, each parameter selection remembers the scale and reference values you last entered.

For example, you can select S_{11} , LOG MAG, at 10 dB/division; and S_{11} , PHASE at 5 degrees/division. Now if you go back and forth between LOG MAG and PHASE display, you can see that the scale switches as well.

For each parameter, the following information is memorized by the analyzer:

1. The last selected format (Log Mag, Phase, Smith Chart, and so on).
2. The last selected response settings (display scale and reference, and so on).
3. Whether calibration was last On or Off for the parameter. This makes it very easy to switch between displays of different parameters without having to specify the format each time.
4. The display color setting.

Factory Preset always establishes a fixed definition for the complete Channel/Domain/Parameter/Format/Response limited instrument state memory.

INSTRUMENT STATE Block

The four keys in the INSTRUMENT STATE block near the bottom of the front panel, save and recall instrument states.

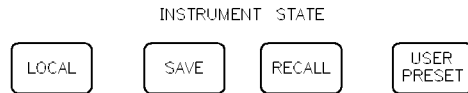

Figure 1-9. INSTRUMENT STATE Block

The instrument state contains virtually all instrument settings, including the controlled functions of the source and the test set. The contents of calibration and trace memories being used are not saved, only the current reference to that memory.

USER PRESET Key

The green **USER PRESET** key can be pressed at any time to return the network analyzer to a predefined state. The preset function performs all necessary internal network analyzer initialization, then recalls instrument state 8. **USER PRESET** does not send an initialization signal to the other instruments on the System Bus. The instrument conditions saved into save/recall register 8 is the defined preset state. Save/Recall keys are discussed later in this chapter.

If a known preset condition is desired, there is another type of initialization that can be done, Factory Preset. This type of preset initializes all instrument state functions to the default conditions (except for frequency range) and initializes all instruments on the System Bus. Because an instrument preset is sent to all instruments on the System Bus, the time required for this operation to complete depends on the instruments connected. Instrument state is defined and a list of default conditions is given at the end of chapter 3, “*Basic Principles of Operation*”. A Factory Preset is demonstrated at the beginning of the example “Using Menus”, later in this chapter.

Saving and Recalling Complete Instrument States

1. Press **SAVE** to bring the instrument state select menu onto the display.
2. Press the **1** **2** **3** **4** **5** **6** **7** or **8** softkey to save the current complete state of the network analyzer in the corresponding storage register (1 through 8).
3. Press **RECALL** **1** through **8** to recall an instrument state that you saved earlier.

LOCAL Key

If the network analyzer system is under external computer control, pressing **LOCAL** returns control of the system to the network analyzer front-panel and displays the address menu. When a Local Lockout command is issued from an external controller, the **LOCAL** key is not effective.

Introductory Measurement Sequence

Introduction

There is no better way to appreciate the speed and accuracy of an 8510C network analyzer system than by performing an actual measurement on a device. Use a device with known characteristics to use this introductory measurement sequence. The sequence suggests a simple test device, but you may measure any appropriate device.

Procedures described in this section assume that the network analyzer system is properly installed, otherwise, refer to Chapter 9, “System Installation” in the *Agilent 8510C On-Site Service Manual*. The procedures also assume that the system is functioning within its operating specifications.

Initially, the system operation needs verification as explained in “Verifying System Setup.” Then begin with the first stage of four stages in the example measurement sequence, as listed below:

- | | |
|---|--|
| 1. Setting Up the Measurement | Learn about making connections and checking the connectors. Then, choose the instrument settings appropriate for the intended measurement. |
| 2. Performing Measurement Calibration | Learn to establish a magnitude and phase reference for the test setup. Then, remove measurement errors to the desired degree. |
| 3. Measuring the Device Under Test | Learn about connecting the device under test (DUT), then measuring it with a network analyzer. |
| 4. Saving and Getting an Output of the Result | Learn about getting the measurement results data to a printer or a plotter, onto a disc, or saved to memory. |

Verifying the System Setup

Verifying the system setup involves checking the system bus addresses.

Press the front panel key labeled **LOCAL** to display the address menu. Check the address of each instrument to verify whether it is the same as the setting shown on the display. For incorrect addresses, those different from the addresses listed below, and shown in the active entry area, use the instrument front-panel entry controls to correct the addresses.

The network analyzer system bus checks for the various system instruments at the following addresses:

Source	Address 19 for any of the compatible sources
Test Set	Address 20 for any of the compatible test sets
Printer	GPIB address 1 for printers
Plotter	GPIB address 5 for plotters
Network Analyzer (8510)	Address 16 for the network analyzer

If some instruments do not respond at power-up

After system power is turned ON, instruments addressed differently from the expected value cannot respond to the network analyzer. Messages indicating possible causes are displayed. After power-up, for instruments that do not respond but are connected properly, check the instrument address assignments.

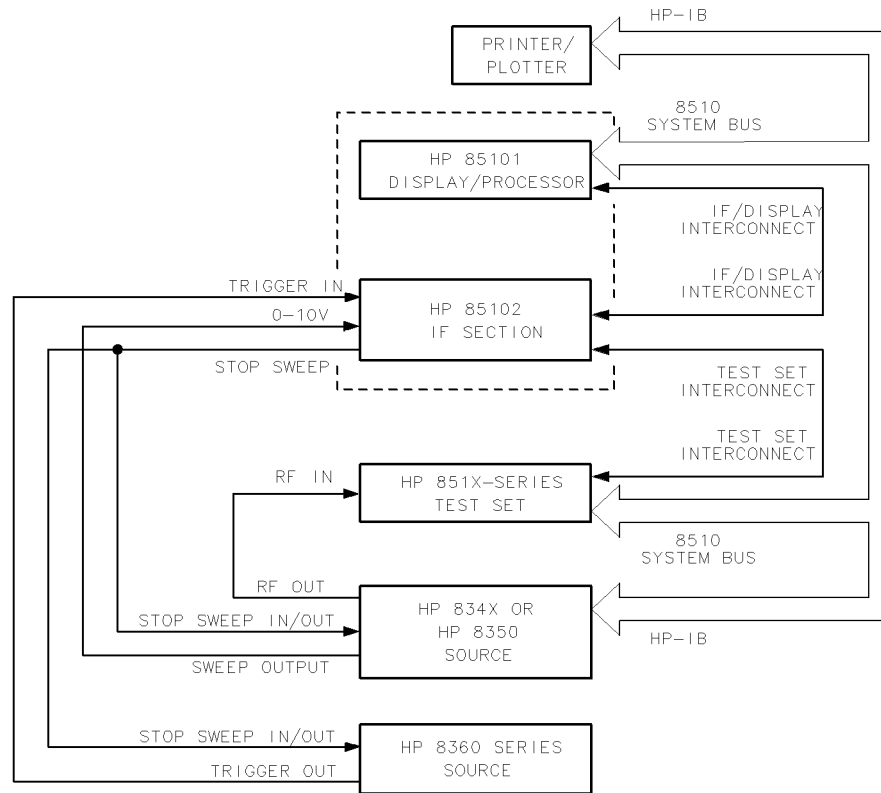

Figure 2-1. Network Analyzer System Interconnections

If you need more information about system connections, refer to Chapter 9, “System Installation” in the *Agilent 8510C On-Site Service Manual*.

Turning on system power, the sequence

Do not use an external controller during this procedure if you have an external computer-controller in the network analyzer system.

Note **Turn on the network analyzer last.** It is turned on after all other instruments in the system are turned on so that the network analyzer can gain control of instruments connected to the System Bus.

For individual instruments, set the line switch of each instrument in the network analyzer system to ON, turning on the *network analyzer last*. If your instruments are mounted in the Agilent 85043C system rack, set the main power switch to ON.

Allow each instrument to complete its initialization routine. A measurement trace appears on the system display when the system is ready to make a measurement.

2-2 Introductory Measurement Sequence

If the network analyzer fails to turn on, be sure the rear panel LINE switch is set for the proper line voltage. Make sure the corresponding red switch is set to “SYSTEM CONTROLLED.”

Waiting for self-test and initialization

The network analyzer self-test and initialization sequence automatically begins at power-up or when the recessed TEST button on the analyzer’s front panel is pressed. This sequence tests the various buses and circuits in the network analyzer, including operational checks of the system instruments connected to it. Only the source and test set are checked; system peripherals such as a plotter are not checked until its use is requested by the network analyzer. If the system passes all of the tests in sequence, the measurement operating system is activated, recall register 8 (Instrument State 8) is recalled, and measurements can begin.

The analyzer displays the following information as it performs the self-test and initialization routine called on power-up.

1. The word **TESTING** appears briefly on the LCD/CRT. This indicates that the display is operating correctly.
2. The message **LOADING OPERATING SYSTEM** is displayed to indicate that the analyzer passed self-test and the firmware operating system is being loaded from non-volatile memory to active volatile memory.
3. **SYSTEM INITIALIZATION IN PROGRESS** is displayed in the upper left-hand corner. This indicates that the system has completed the self-test sequence successfully.
4. **RECALLING INSTRUMENT STATE** appears below the system initialization message and Instrument State 8 is recalled.

When self-test and initialization are complete, the LCD/CRT displays a graticule and a trace. If not, or if a caution or a warning message appears on the analyzer LCD/CRT, refer to Chapter 9, “System Installation,” in the *Agilent 8510C On-Site Service Manual*. Also, refer to the section labeled “Operator’s Check and Routine Maintenance” at the end of this manual for information about the TEST (recessed front panel button). Use this section to check the system further if you suspect there is a problem.

Measurement Sequence Example 1: Frequency Domain Measurement

The illustrations in this sequence indicate making a typical Frequency Domain measurement. The sequence includes an example of a measurement calibration for reflection and transmission measurements. The figures illustrate typical displays of the following:

- Return Loss (S_{11}) in LOG MAG format
- Insertion Loss (S_{21}) in LOG MAG format

In this example, measure a bandpass filter or a simple transmission line with 3.5-mm or 7-mm connectors, or connectors that correspond with the test port connectors on the network analyzer test set. If another connector type is needed, then install converting adapters for 3.5 mm or 7 mm operation. Consider the adapters as part of the test device. In addition, you need a 3.5-mm or 7-mm calibration kit for the system.

1. Setting Up the Measurement

Refer to Figure 2-2 for the instrument setup used in this example. For S-parameter test sets, the calibration and device measurements use a matched set of test port return cables.

For reflection and transmission test sets, the calibration and DUT measurements are performed at Port 1, with an attenuator pad and a single test port return cable attached to Port 2.

Making Connections

Accuracy and repeatability in microwave measurements require care and skill, especially in making connections. Not only does a bad connection or connector produce bad data, but damage to the equipment is likely, requiring replacement of the parts or time consuming and costly repairs. Moreover, work at Agilent on connector repeatability has shown clearly that it is essential to inspect and clean all connectors before every use, if accurate measurements are to be made. Dirt and contamination on connectors are the most important single source of measurement problems, causing poor accuracy and poor repeatability.

Caution

AVOID STATIC DISCHARGE

When making a connection to the test set, be sure to wear a grounded wrist strap and group the equipment before touching connectors. Avoid touching the center conductor of a connector.

Wear a grounded wrist strap and grasp the outer shell of the test port briefly before touching the connector. This prevents electrostatic discharge (ESD) that can severely damage the sensitive sampler circuit diodes in the test set.

Make connection inspection part of your routine. Before performing any calibrations or making measurements, check:

- That all connectors are undamaged and clean.
- That the mechanical dimensions of the connectors, as checked with a connector gage, are within mechanical specifications.
- That all connections are made in a way that assures consistent and repeatable mechanical (and therefore electrical) contact between the connector mating surfaces.

Detailed information on inspecting and cleaning connectors, and on making connections, appears in the calibration kit manuals and the Agilent *Connector Care Manual* and is summarized in the verification kit manuals.

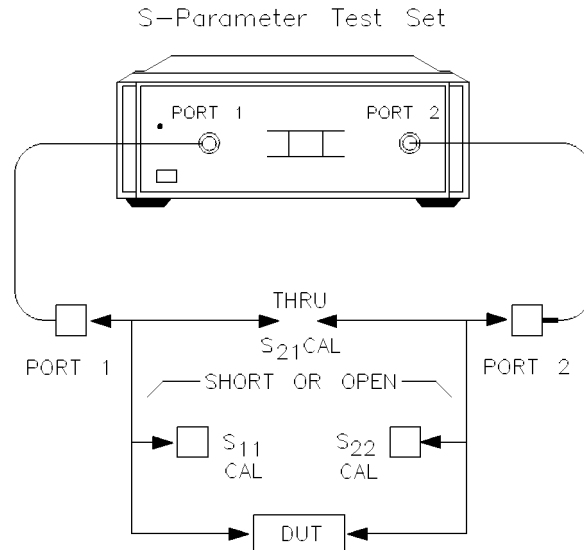

Figure 2-2. Measurement Sequence 1, Test Setup

Factory Preset State

In order to set the instrument to a known state and begin the procedure, press **RECALL** **MORE FACTORY PRESET**. A partial list of the standard Factory Preset state conditions for the analyzer system is given in Chapter 3, Table 3-1. Except for the frequency range, which depends upon the capabilities of the source and test set, these Factory Preset conditions cannot be changed.

Set Stimulus, Parameter, Format, Response

Use the function keys in the **STIMULUS**, **PARAMETER**, **FORMAT**, and **RESPONSE** function blocks together with the **ENTRY** block keys to set the source and choose the type of measurement and display desired. The following settings are used in this example:

Stimulus	Continuous sweep, ramp sweep mode, start frequency = 0.5 GHz, stop frequency = 18 GHz, sweep time = 100 ms/sweep
Parameters	Channel 1 = S_{11} , channel 2 = S_{21}
Format	LOG MAG
Response	Automatic, to let the analyzer choose the scale/division and the reference position.

□ Set **STIMULUS**.

1. To set the start frequency, press the **START** key in the **STIMULUS** function block. For this example, press **START** **0** **.** **5** **G/n**.
2. Now set the desired stop frequency. Press **STOP** **1** **8** **G/n**.

Selections appear below the graticule (grid) and in the active entry area of the display as you make them.

The Factory Preset state selects the continuous, ramp sweep mode and a sweep time of 166 ms/sweep. If distortion appears in the trace, a slower sweep time can be selected.

To change the sweep time:

1. Press the **STIMULUS** block **MENU** key, then the softkey labeled **SWEEP TIME**.

2. Use the ENTRY block controls to set the new sweep time. Enter the value, then press either the **(x1)** key, if the value is in seconds, or the **(k/m)** key if the desired value is in milliseconds.

□ Set PARAMETER.

Use the PARAMETER keys to select the parameter to be measured and displayed. The Factory Preset state initializes channel 1 to measure S_{11} , channel 2 to measure S_{21} , and selects the single channel display mode. Thus, after **FACTORY PRESET**, channel 1 displays S_{11} and pressing **(CHANNEL 2)** displays S_{21} .

The LED indicators above the channel buttons indicate the channel currently selected. Any parameter can be displayed using either channel.

□ Set FORMAT.

Use the FORMAT keys to select the type of graticule (grid) used for display of the measured data. The standard Preset state initializes channel 1 and channel 2 to display power ratio versus frequency using the **LOG MAG** graticule.

Any format can be selected for the display of any parameter.

□ Set RESPONSE.

Use the RESPONSE keys, **(SCALE)**, **(REF VALUE)**, and **(REF POSN)** to position the trace on the LCD/CRT for viewing. Select the channel and parameter, press the key representing the value you wish to change, then use the knob, step keys, or the numeric and **(x1)** unit keys to change the value.

Press the **(AUTO)** key to automatically select a scale/division value (Scale) and reference position to display the entire trace. **(AUTO)** works best when the reference position is set near the center horizontal graticule line.

See Figure 2-3 for a typical thru-response display.

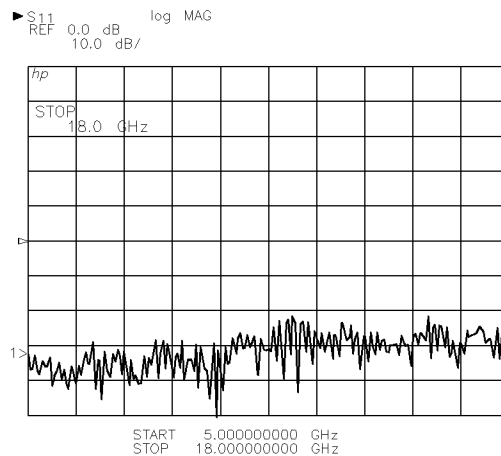

Figure 2-3. Initial Display Showing a Thru Connection

2. Performing the Measurement Calibration

The different types of measurement calibrations offer a different degree of accuracy. For comprehensive information about measurement calibration, refer to Chapter 8, “Measurement Calibration.”

In this example, two types of calibrations are used: 1) Reflection and 2) Transmission Frequency Response Calibrations.

Making a reflection frequency response calibration

A reflection frequency response calibration removes systematic errors encountered during reflection measurements. This calibration is identified as an S_{11} response calibration.

To Identify, Create, and Store S_{11} Measurement Calibration Data. To follow this example, use a standard 85052 3.5-mm calibration kit.

1. Press **CHANNEL 1**. In the PARAMETER function block, press **S11**.
2. In the MENUS block, press **CAL** to display the Calibration menu.

The name of each of the current calibration kits available internally are listed as the second line of the **CAL 1** and the **CAL 2** softkey labels.

The name of the calibration kit used for the calibration should match the connector type of the test port connector. If a different calibration kit has been defined and installed, some of the key labels relating to calibration standard selection may be different, but the general sequence is similar.

If a calibration kit appropriate for the test port connections is not listed, another can be loaded inserting the appropriate calibration kit device characteristics data disc supplied with the Agilent calibration kit, then using the **DISC LOAD CAL KIT 1-2 CAL KIT 1 FILE n** softkey sequence.

3. Select **CAL 1 3.5 mm B.x**, where x is the specific issue of the calibration kit. This step identifies the type of calibration kit used and displays the calibration type menu.
4. Select **CALIBRATE: RESPONSE**. This selects the type of calibration and displays the frequency response calibration menu.
5. Notice the prompt on the display. Connect the shielded open supplied in the calibration kit to port 1 of the test set (the same port where the device under test is connected). Channel 1 displays the uncorrected reflection signal path frequency response of the shielded open circuit. See Figure 2-4.
6. When the trace is stable, select **OPEN** to measure the reflection path frequency response. A prompt on the display tells you to wait for the analyzer to take the data. When the analyzer is finished taking data, the **OPEN** key is underlined.
7. When the message **WAIT--MEASURING CAL STANDARD** disappears, press **DONE RESPONSE** to indicate that the frequency response calibration is complete.
8. When the **SELECT CALIBRATION SET** prompt appears on the display, select **CAL SET 1** to store the calibration data. Now the calibration menu is displayed with **CORRECTION 1 ON** underlined.
9. Press **LOG MAG** and **PHASE** to observe the magnitude and phase response of the calibration standard.

Reading the displayed response. The displayed trace represents the current measurement normalized to the modeled response of the shielded open circuit.

- For the 3.5 mm calibration, this is 0 dB Return Loss with some phase shift due to the electrical delay of the offset and some phase shift due to reactive response.
- For the 7 mm calibration, this is 0 dB Return Loss with some phase shift due to the reactive response of the shielded open circuit.

The measurement calibration process has removed the reflection signal path frequency response errors of the system. The network analyzer can now measure reflection, with the analyzer frequency response corrected to the response of the shielded open circuit, on either channel, in either domain, using any format. The display should look similar to Figure 2-5.

Making a transmission frequency response calibration

A transmission frequency response calibration removes many systematic errors found in transmission measurements. This calibration is identified as an S_{21} response calibration.

To Identify, Create, and Store S_{21} Measurement Calibration Data.

1. Press **CHANNEL 2**, then, in the PARAMETER function block, select **S21**.
2. In the MENUS block, press **CAL**, then press **CAL 1 3.5 mm**. This displays the calibration type menu on the LCD/CRT.
3. Press **CALIBRATE: RESPONSE** to display the frequency response calibration menu.
4. Make a thru connection by connecting the two points where the two-port device will eventually be connected. Channel 2 displays the frequency response of the uncorrected transmission signal path.
5. When the trace is stable, indicating that the thru is properly connected, press **THRU** to measure the transmission signal path frequency response. See the example in Figure 2-6.
6. When the message **WAIT--MEASURING CAL STANDARD** disappears, press **DONE RESPONSE** to indicate that the frequency response calibration is complete.
7. Press **CAL SET 2** to store the calibration data. The calibration menu reappears with **CORRECTION ON** underlined.
8. Press **LOG MAG** and **PHASE** to observe the magnitude and phase response of the calibration standard.

At this point the displayed trace represents the current measurement normalized to the modeled response of the thru (0 dB Insertion Loss, with 0 degrees phase shift). The measurement calibration process has removed the transmission signal path frequency response errors of the system. The network analyzer can now measure transmission characteristics, with the analyzer frequency response corrected to the response of the thru connection, on either channel, in either domain, using any format. The screen will look similar to Figure 2-7.

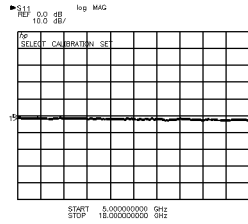

Figure 2-4. Display with Open Circuit Connected

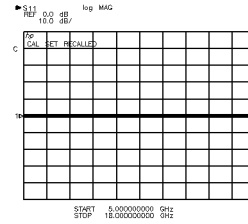

Figure 2-5. Display with S_{11} Response Calibration ON

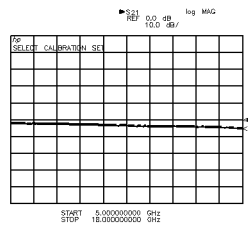

Figure 2-6. Display with Thru Connected (S_{21} Calibration)

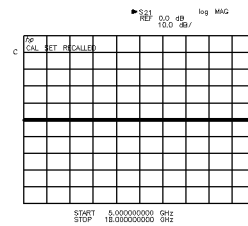

Figure 2-7. Display with S_{21} Response Calibration ON

3. Making a Measurement

In this step, an actual measurement is completed.

To measure return loss (S_{11}) in LOG MAG format (frequency domain measurements)

In the frequency domain mode, the X-axis of the display represents the frequency span. In frequency domain, observe the performance characteristics of your DUT with respect to frequency.

1. Connect the device under test between Port 1 and Port 2 as shown in Figure 2-2.
2. Read the Return Loss of the DUT.
 - a. Press **CHANNEL 1** **S11** **LOG MAG** **MARKER**.
 - b. Use the RPG knob to position the marker at any point on the trace. The measured return loss, magnitude and value at the marker position is displayed above the graticule. The frequency value is displayed in the active function area. See Figure 2-8 for an example of the typical display.
3. To read the measured phase angle, press **PHASE**.
4. To position the trace automatically for viewing, press **AUTO**.

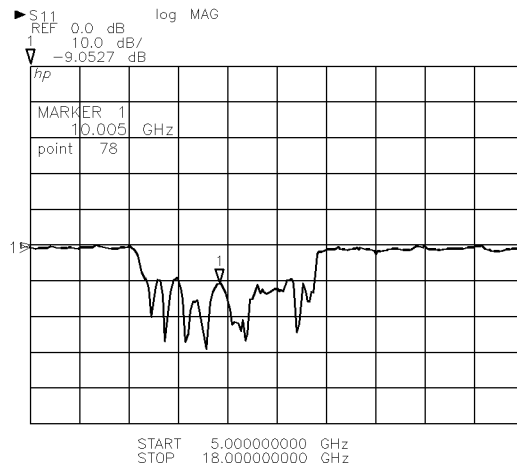

Figure 2-8. Return Loss: S_{11} LOG MAG

To measure the insertion loss (S_{21}) in LOG MAG format

1. Read the Insertion Loss of the DUT.
 - a. Press **CHANNEL 2** **S21** **LOG MAG** **MARKER**.
 - b. Use the RPG knob to position the marker at any point on the trace. The measured Insertion Loss, magnitude value at the marker position, is displayed above the graticule. The frequency value is displayed in the active function area. See Figure 2-9 for an example of a typical display.
2. To read the measured phase angle, press **PHASE**.
3. To position the trace automatically for viewing, press **AUTO**.

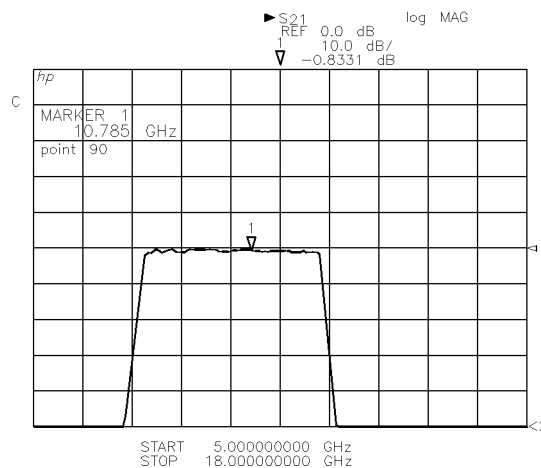

Figure 2-9. Insertion Loss: S_{21} LOG MAG

4. Saving Data and Getting an Output of the Results

You may save the measurement data to the analyzer's internal memory, or save data to the internal or an external disc drive.

To print or plot the results of the measurements, refer to the steps below. For simplicity, this example uses the plotting capability. To learn about the other output formats, refer to Chapter 6, "Copy: Printing and Plotting," and Chapter 7, "Disc Functions" in this manual.

Plotting Advantages

- Plotters have higher resolution than printers.
- Plotters allow portions of the display to be selectively plotted.
- Plot up to four images on a single sheet of paper with the "select quadrant" feature. Refer to Chapter 6, "Copy; Printing and Plotting" for an example of this feature.

To set up the plotter

1. Identify the plotter connection type needed (either GPIB or RS-232).
2. Connect the plotter to the System Bus or to one of the RS-232 ports.
 - If the plotter is GPIB , check its address. Verify that the analyzer address matches the plotter's. Press **LOCAL** **MORE** **ADDRESS of PLOTTER: HP-IB**
 - If the plotter is an RS-232 type, check that the analyzer is set to send information to the RS-232 port where the plotter is connected. Press **LOCAL** **MORE** **ADDRESS of PLOTTER: RS-232 PORT #1** or **ADDRESS of PLOTTER: RS-232 PORT #2**.
3. Choose the type of plot desired, color or monochrome.
4. On the network analyzer press, **COPY** **DEFINE PLOT** **PLOT TYPE: COLOR** or **PLOT TYPE: MONOCHROME** .
5. Load the paper in the plotter.

Check

plotter pens

Monochrome plots require only one pen to execute plots.

Color plots use more than one pen, therefore, you need to select the pens and select associated slot numbers.

1. Press **SET PEN NUMBERS** to display the Select Pen Numbers menu.
2. Change the pen-slot assignments for the different display elements, or place pens in appropriate slots, as indicated on the menu.

Refer to Table 2-1 for ideas about pens and the pen-number slot selections.

Table 2-1. To Match Pen Colors to Display Default Colors

Color	Pen Size	Pen Slot	Plots
Black	3	1	Grid, Markers, Stimulus values
Red	3	2	Warnings
Orange	3	3	S ₁₁ data and memory
Green	3	4	S ₂₂ data and memory
Aqua	3	5	S ₂₁ data and memory
Red-Violet	3	6	S ₁₂ data and memory

Plotting the Current Display

To plot all of the elements of the current display: Press **COPY** **PLOT TO PLOTTER** **PLOT: ALL**. The analyzer freezes the current display and sends it to the plotter. Once the data is transferred to the buffer, the analyzer is available for use while the data is plotting.

To plot selected areas of the results display

Press **COPY** **PLOT TO PLOTTER** **PLOT: xx**, where xx represents a category, as shown on the Plot to Plotter menu. Categories may be plotted independently. The categories of the display are listed in Table 2-2:

Table 2-2. Plot Category Key Choices

Category	Description of What Gets Plotted
Data	the displayed trace or traces
Memory	a measurement trace stored in memory that appears on the display
Graticule	the display graticule
Marker(s)	the display markers and their values
Title	a title created by the operator (refer to Chapter 6 of this manual)
Text	all visible text on the display
Limits	plots the limit display when limits are available (refer to the section titled “Limits” in the DISPLAY menu key descriptions of Chapter 4)

Measurement Sequence Example 2: Time Domain

If your 8510 system is equipped with Option 010, Time Domain, you can perform the following additional steps to display measurement in Time Domain.

In time domain mode, the X-axis of the graticule represents time or physical distance. Time domain allows you to see the performance characteristics of your DUT, with respect to time or distance.

The procedure in this sequence is for making a typical Time Domain measurement. The illustrations display examples of the following results:

- Time Domain measurement of a short circuit
- Time Domain measurement of an air line and short circuit
- Time Domain measurement of a cable (a “thru” connection)
- Time Domain measurement of an air line

To measure time domain reflection response of a short, follow the procedure below:

1. Disconnect the device under test and connect the short circuit device at port 1.
2. Press **CHANNEL 1** **S11** **DOMAIN** to present the Time Domain menu, then press **TIME BAND PASS**. The time band pass mode provides a Time Domain presentation suitable for limited bandwidth test devices.
3. Position the marker on the peak of the response by pressing **MARKER** **MORE** **MARKER** to **MAXIMUM**.

For 7 mm, the measured time value should be near 0 seconds, meaning that the short circuit is connected to port 1 at the same point at which reflection measurement calibration was performed. For 3.5 mm, the peak will be displaced from 0 seconds due to the electrical delay of the offset short circuit. See Figure 2-10 for an example of the display.

4. Remove the short circuit, install an air line (a 20 cm air line is shown in this example) at port 1, and install the short circuit at the end of the air line.

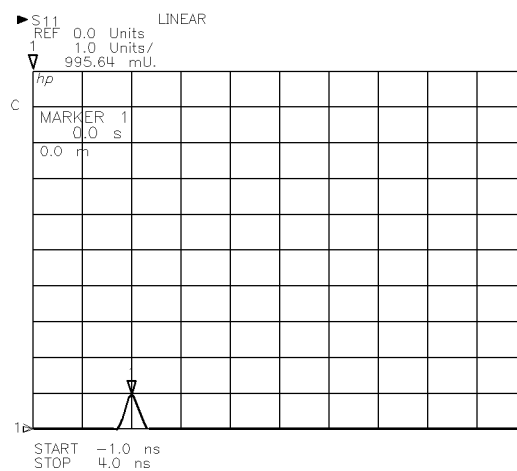

Figure 2-10. Time Domain Refl Response Short Circuit: S_{11} TIME BANDPASS

To measure time domain reflection response of an air line and a short, follow the procedure below:

The peak response moves away from 0 seconds, out to approximately 1.35 nanoseconds. This indicates that the short circuit is displaced that amount from the point at which the reflection measurement calibration was performed.

The peak response value represents twice the actual electrical propagation delay of the air line because the signal travels its length twice: to the short circuit, then back again to the port 1 measurement plane. See Figure 2-11 for an example of the results display.

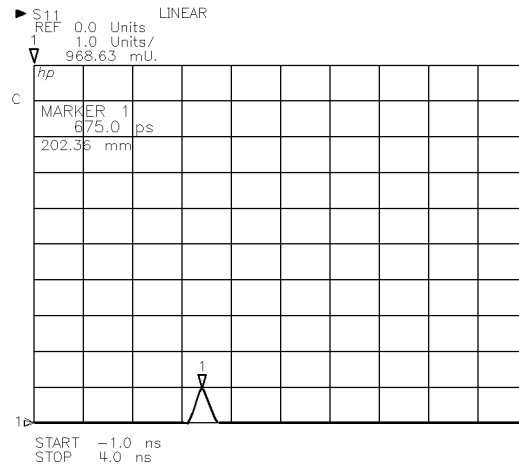

Figure 2-11. Time Domain Reflection Response of an Air Line and Short Circuit

To measure time domain transmission response of a thru, follow the procedure below:

1. Connect a thru to measure.
 - a. Disconnect the short circuit and the air line.
 - b. Press **CHANNEL 2** **S21** **DOMAIN** **TIME BAND PASS**.
2. Position the marker on the peak of the response. The measured time value should be near 0 seconds, indicating that the transmission return cable is connected to the point at which the transmission measurement calibration was performed. See Figure 2-12 for an example display.

Principles of Operation

Introduction

Information in the next 8 chapters of this system manual helps you maximize the capabilities of your 8510 system. The sections describe the network analyzer hardware and explain some of its principles of operation.

The contents of Chapter 3, provide an overview of the sections listed below:

- Basic Principles of Network Measurements
- Digital Signal Processing
- Test Signal Sources
- Test Sets
- Measurement Accessories
- Factory Preset State
- Hardware State

Basic Principles of Network Measurements

Vector network analyzers such as the 8510 network analyzer system measure the magnitude and phase characteristics of electronic networks and components such as filters, amplifiers, attenuators, and antennas. The standard configuration described here measures linear components stimulated by a swept or CW signal. These configurations can make either *reflection measurements* or *transmission measurements*.

An incident signal generated by an RF source controlled by the HP 8510 is applied to the test network and compared with the signal reflected from the test network input or transmitted through it. See Figure 3-1.

Network Analyzer System Description

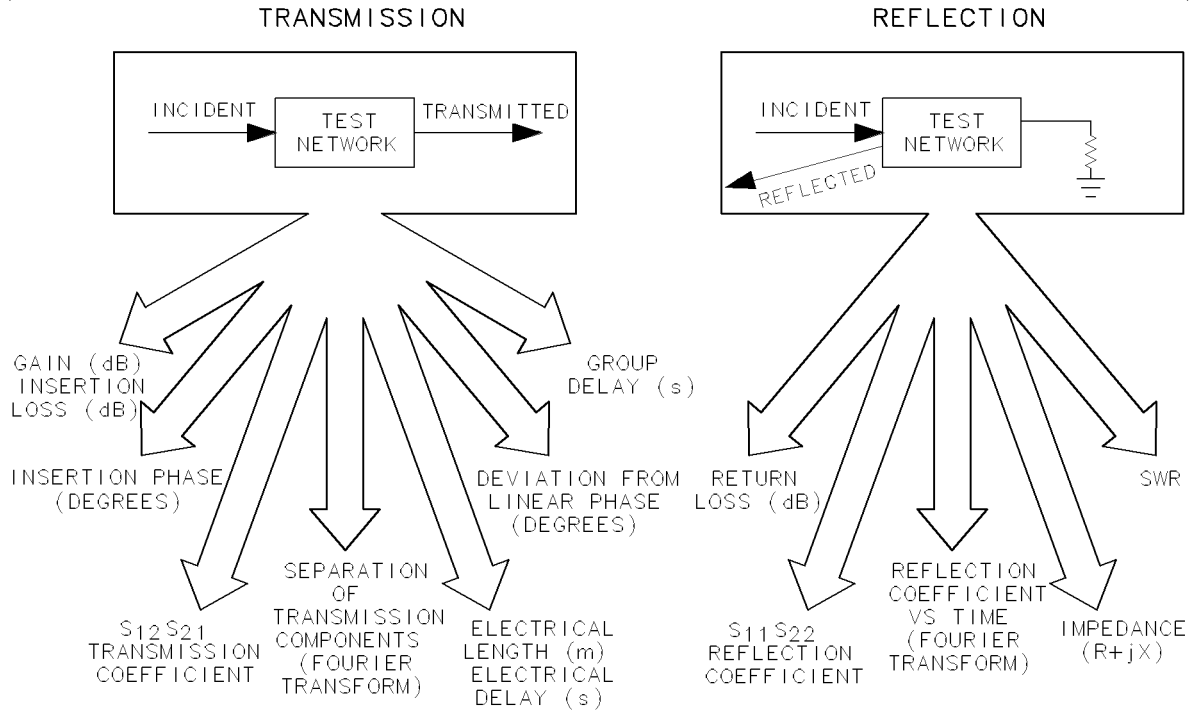

Figure 3-1. Reflection and Transmission Measurements Diagrammed

Reflection measurements These are made by comparing the reflected signal to the incident signal. Measurement data about reflection characteristics of the test network that can be generated and used to examine the test network include the following:

- Return Loss,
- Standing Wave Ratio (SWR),
- Reflection Coefficient, and
- Impedance.

Transmission measurements These are made by comparing the transmitted signal to the incident signal. The measurement data about the transmission characteristics of the network include the following:

- Insertion Loss or Gain,
- Transmission Coefficient,
- Electrical Delay from which Electrical Length can be obtained,
- Deviation from Linear Phase, and
- Group Delay.

By application of the incident signal to the test network output port, the reverse characteristics, output impedance and reverse transmission, can be measured.

Because both magnitude and phase can be measured, precision standards can be used to characterize the main sources of measurement uncertainty for the purpose of enhancing the accuracy of the displayed trace.

Mathematical analysis of the swept reflection response using Fourier Transform principles makes it possible to determine the position and magnitude of impedance changes with respect

3-2 Principles of Operation

to a reference plane. Similarly, analysis of the transmitted response allows you to examine different signal paths.

These measurements and accuracy enhancement techniques are further described in this chapter.

System Block Diagram

Figure 3-2 is a simplified block diagram of the general-purpose 8510 network analyzer system.

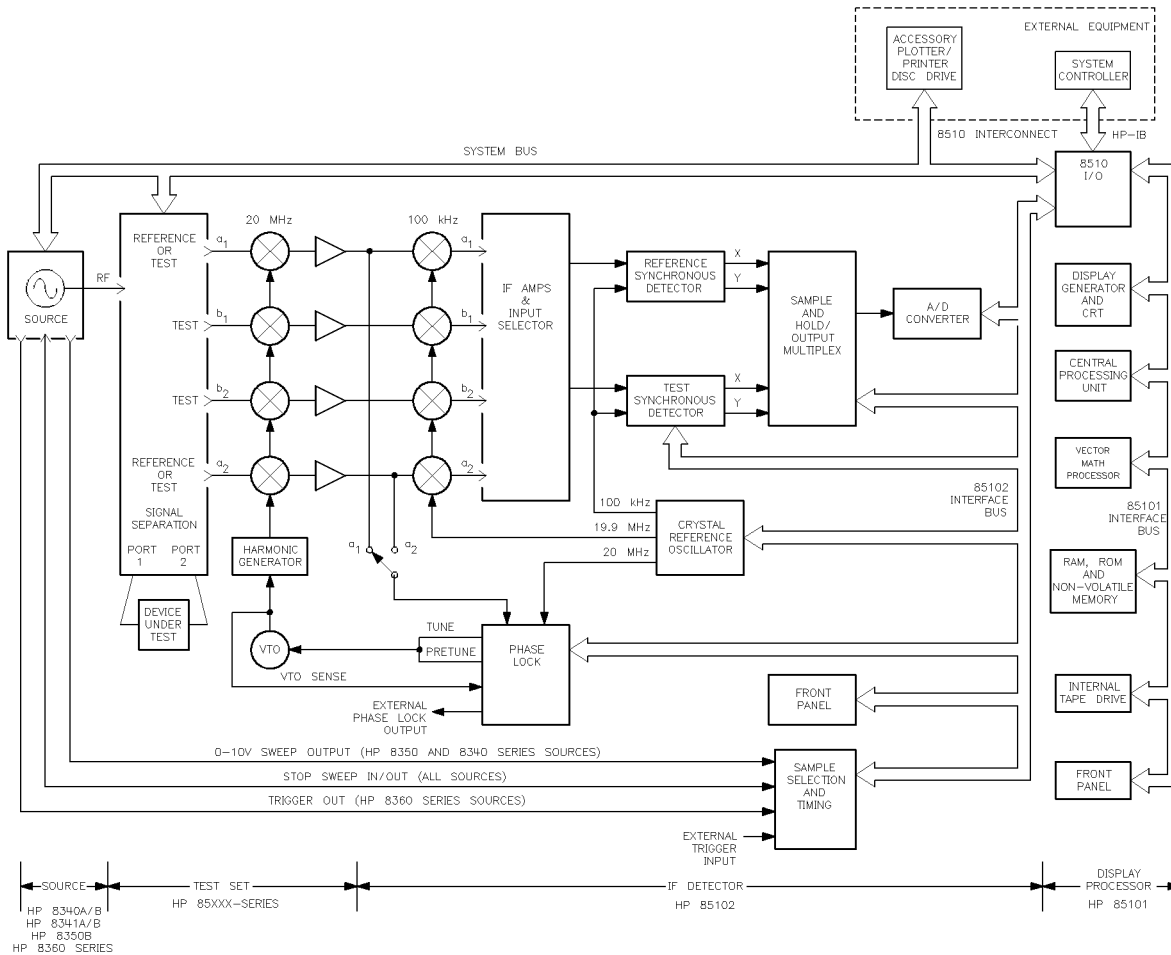

Figure 3-2. Simplified System Block Diagram

Description of the 8510 Network Analyzer

The 8510 is a high performance vector receiver. The instrument has four inputs, two independent measurement channels, and an internal microcomputer to automate measurements, conduct data processing, display results, and manage data input/output operations.

The dedicated system bus provides fast digital communication between individual system instruments, allowing the network analyzer to fully use the source and test set capabilities. The interface also provides direct data transfer to the hardcopy device for permanent records of measurement displays.

Network Analyzer System Description

How the 8510 Makes Measurements

In a typical measurement, the signal source is swept from the lower measurement frequency to the higher measurement frequency using a linear ramp controlled by the 8510. The sweep is called a ramp sweep. Ramp sweep offers the fastest update of the measurement display. In step-sweep mode, the source is phase-locked at each discrete measurement frequency controlled by the 8510.

At the first frequency conversion stage, signal separation components in the test set apply a portion of the incident signal and the responses from the device under test to the first stage. Digital communication between the receiver and the test set pre-tunes the 65 MHz to 300 MHz voltage-tuned local oscillator (VTO) so that one of its harmonics mixes with the stimulus to produce a 1st IF frequency close to 20 MHz.

Fine tuning is accomplished by comparing the IF frequency with the internal 20 MHz crystal reference and sweeping the local oscillator to track the stimulus frequency.

When the local oscillator reaches its upper frequency limit, the sweep is stopped, the local oscillator is tuned again, phase lock is reestablished, and the sweep is continued. Since the first local oscillator frequency is selected algorithmically from a known stimulus frequency, the measurement is free of harmonic skip.

The second frequency conversion produces an IF frequency of 100 kHz for application to the detection and data processing elements of the receiver. Because the frequency conversions are phase-coherent and the IF signal paths are carefully matched, magnitude and phase relationships between the input signals are maintained throughout the frequency conversion and detection stages. Automatic, fully calibrated, autoranging IF gain steps maintain the IF signal at optimum levels for detection over a wide dynamic range.

Test and Measurement Input Channels

Each measurement channel can use either input a_1 or a_2 as the reference signal; b_1 and b_2 are always used for the test signal.

The unused reference channel can be used to measure a third test signal. For example, assume you choose a_1 as the phase-locking reference channel. You can now use a_2 as a third measurement channel.

Ratio Measurements and Sampling Details

Depending upon the test set configuration, the appropriate reference input and test input are ratioed to obtain the measurement.

During a ramp sweep, the selected inputs are sampled up to 801 times, with sample timing accomplished by sensing the 0 to 10 V sweep output from the source. For example, with 401 points selected, at each positive 0.025 V change in the sweep voltage, all selected inputs are sampled and applied to the reference and test synchronous detectors.

In step sweep, the selected inputs are sampled a certain interval after phase lock is established.

Each synchronous detector develops the real (X) and imaginary (Y) values of the reference, or test signal, by comparing the input with an internally generated 100 kHz sine wave. This method practically eliminates measurement uncertainty errors resulting from drift, offsets, and circularity. Each X,Y data pair is sequentially converted to digital values and read by the central processing unit (CPU).

3-4 Principles of Operation

Digital Signal Processing

Digital signal processing (DSP), Figure 3-3, proceeds under control of the 8510 firmware operating system executed by the main CPU (central processing unit).

CPU and Memory Description

The CPU is a 32-bit Motorola 68000 microprocessor equipped with 1 Mbyte of RAM, and 512 Kbytes of EEPROM. The firmware operating system is stored permanently in non-volatile memory, then loaded into active (volatile) memory each time power is applied.

The CPU takes advantage of multi-tasking software architecture, and several distributed processors, to provide a very fast data-acquisition and display-update rate. The CPU accepts the digitized real and imaginary data, corrects for IF gain and quadrature errors before the reference and test pairs are ratioed. If 0 is selected, the data is averaged, then stored in channel 1 or channel 2 raw data array.

The constants used in this IF correction are obtained periodically with an automatic self-calibration operation that is invisible to the operator.

Data Processing Steps

While data acquisition software is continually filling the raw data arrays, the data processing software is processing the data for the two independent display channels.

If error correction is turned on, the raw data and error coefficients from the selected calibration coefficient set are used in appropriate computations by a dedicated vector math processor.

Next, magnitude and phase offsets commanded by the electrical delay, reference plane extensions, magnitude offset, and magnitude slope under the RESPONSE menu structure are added to the data. If time-domain mode is available and selected, the corrected data is converted from the frequency domain to time domain using the inverse Fourier Chirp-Z transform technique. The results are stored into the corrected data arrays.

Memory arrays are filled from the corrected data array, by control of the user, with trace data for use in vector computations with current corrected data. If trace math is selected, vector multiplication, division, addition, or subtraction is performed.

Results are formatted according to the FORMAT selection, point-to-point smoothing is applied, if selected, and stored into the formatted data arrays. Traces are now scaled, then sent to the display memory where the trace data is combined with different display annotation data.

A dedicated display processor asynchronously converts the formatted data and annotations for viewing at a flicker-free rate on the vector-writing display.

Network Analyzer System Description

Button Push Detection

When the operating system detects a front panel button push, it responds with one of the following operations:

- Executes the command immediately (as when a parameter change is made).
- Makes the function just selected become the active function, then waits until input from the RPG knob, numeric pad, or step keys (as when there is a scale/division change) is entered.
- Displays the respective softkey menu.

Note

Certain function selections abort the data processing operation. For example, MEASUREMENT **RESTART** restarts all measurement related functions to the beginning of the data acquisition group. These groups are **FACTORY PRESET** or **USER PRESET**. These selections initialize the system to a pre-defined state. In general, changes to the Instrument State of the source are executed after the current sweep is completed.

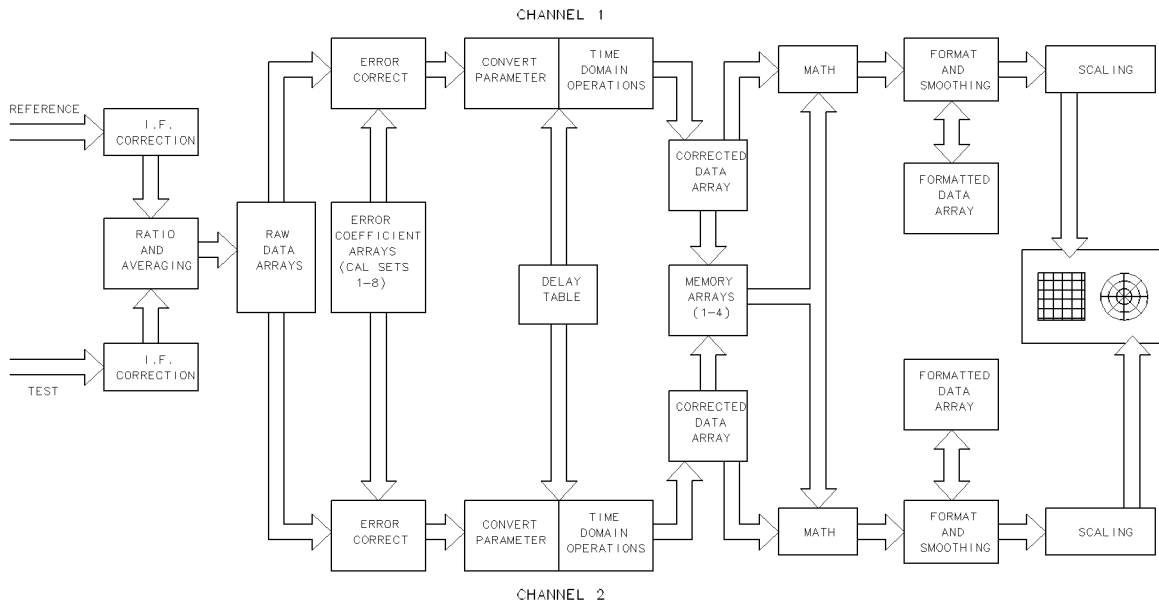

Figure 3-3. Digital Signal Processing

Test Signal Sources

The 8510 network analyzer system accepts any of the following signal sources:

- An 8360 Series Synthesized Sweeper
- An 834x Series Synthesized Sweeper
- An 8350x Series Sweep Oscillator with an 835xx Series plug-in

These sources have the correct analog interface signals and are fully 0 with the 8510 digital system bus. The system bus allows the network analyzer to serve as the system controller by managing the source using standard GPIB protocol.

3-6 Principles of Operation

Sources in ramp-sweep mode

All of the of sources can operate in ramp sweep mode. In this mode, the network analyzer directs the source to sweep in a linear ramp over the selected frequency range.

Synthesized sweepers use the “Lock-and-Roll” tuning technique. With this technique, the first frequency of the sweep is set with synthesizer accuracy and a linear analog sweep increases to the stop frequency.

For narrow frequency sweeps (the width depends upon the frequency range), fully locked synthesizer performance is obtained over the entire sweep. The sweep oscillator uses an open-loop YIG-tuned source. Refer to the source specifications for frequency accuracy and resolution details.

Sources in step-sweep mode

Synthesized sweepers can also operate in the step sweep mode. In this mode, synthesizer-class frequency accuracy and repeatability is obtained by phaselocking the source at each frequency step over the selected frequency range. This mode provides the highest accuracy, although at reduced measurement speed.

Test Sets

Agilent produces many different test sets. The configuration needed depends on the frequency range and measurement capabilities desired. The two most commonly used test set types are the Reflection/Transmission test set and the S-parameter test set. Each test set provides the following:

- Input and output ports for connecting the device to test
- Signal separation for sampling the reference signal and test signals
- Test signal frequency to 20 MHz conversion

Coaxial Test Set Information

The following information applies to coaxial test sets for measurements up to 26.5 GHz. Test sets for other frequency ranges are described in their appropriate documentation.

With standard coaxial test sets, the frequency converter is fully integrated into the signal separation path, and provides optimum performance. Parameter selection is controlled from the network analyzer front panel.

Network Analyzer System Description

Reflection/Transmission Test Sets

Several models of the reflection/transmission test set are available. See Figure 3-4 for a signal flow diagram of a typical Reflection/Transmission test set. The test sets provide automatic selection of S_{11} or S_{21} .

If parameter S_{21} or S_{22} is selected, it is assumed that the operator has manually reversed the device under test. Fully error-corrected measurements for one-port devices can be made using the 1-port calibration procedure.

The one-path 2-port calibration procedure provides full error correction for two-port devices if the DUT is manually reversed. Note that an attenuator is connected at the device end of the transmission return cable.

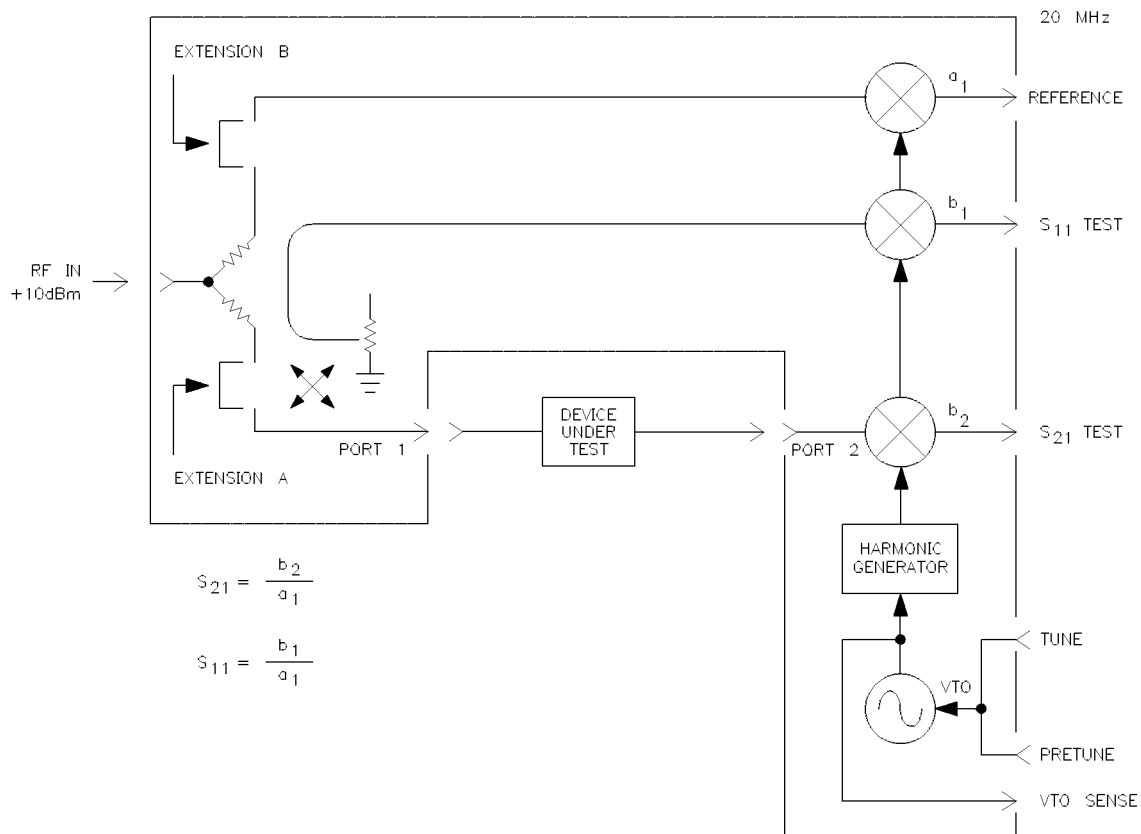

Figure 3-4. Reflection/Transmission Test Set Signal Flow

S-Parameter Test Sets

S-parameter test sets (shown in Figure 3-5) provide automatic selection of S_{11} , S_{21} , S_{12} , and S_{22} . The stimulus is automatically switched for forward and reverse measurements. This capability allows for fully error-corrected measurements on one-port devices and two-port devices without needing to manually reverse the DUT. By taking the ratio after electronic switching, switching path repeatability errors are eliminated.

The bias input and sense connections provided allow the testing of active devices. Internal 10 dB steps attenuators (from 0 dB to 90 dB), are available to control the incident stimulus level at the DUT input, without causing a change in the reference signal level.

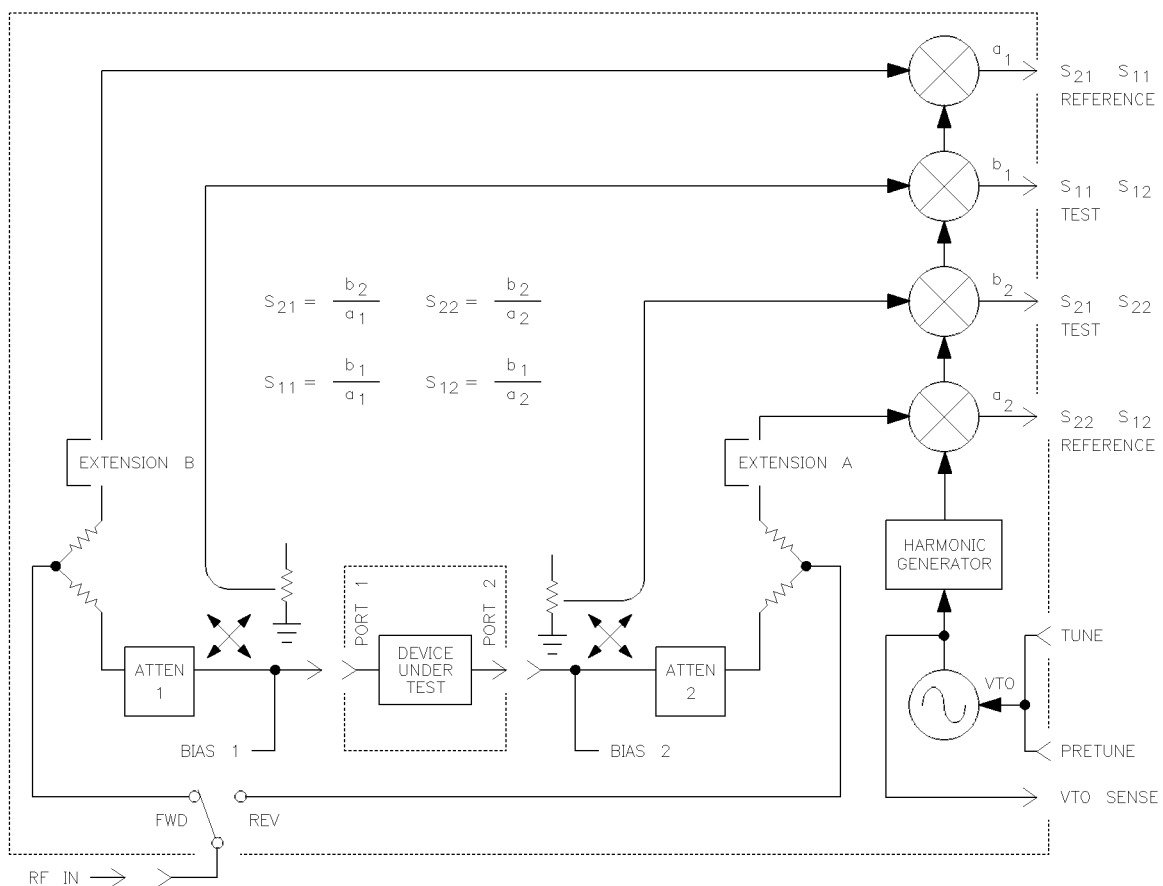

Figure 3-5. S-Parameter Test Set Signal Flow

Network Analyzer System Description

Customized Test Sets

To configure signal separation of your own design, use the 8511A frequency converter (see Figure 3-6). The converter does not include signal separation devices, thus allowing you to construct a test set and connect the reference and test signals to the frequency converter inputs.

If your test setup does not follow the standard conventions of the reflection/transmission or S-parameter test set, use the **REDEFINE PARAMETER** function sequence in the network analyzer system to select appropriate reference and test inputs to use.

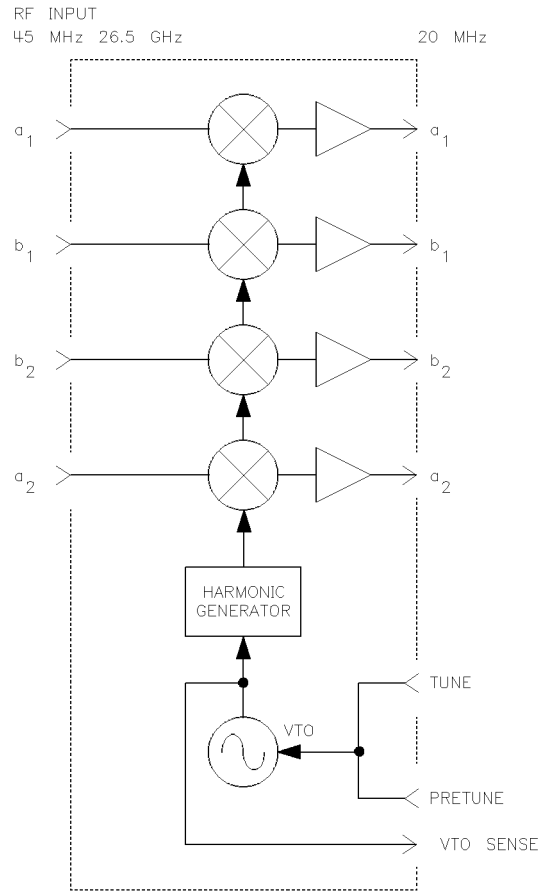

Figure 3-6. 8511A Frequency Converter Signal Flow

Measurement Accessories

Source Output-to-Test-Set Input Signal Cable

Use a high quality source-to-test-set cable set to minimize loss and instability. The preferred source-to-test set cable set is part number 08513-60009. This set has a 3.5-mm male connector on one end and the 3.5-mm female connector on the other. These cables have low loss and are rugged.

Test Port Return Cables

High quality cables, attenuators, and adapters to connect between the test set ports and the device under test are essential to achieve accurate, repeatable measurements. Worn or unstable cables and connectors increase measurement errors due to directivity, mismatch, and frequency response effects. Check cables and connectors regularly and replace them as necessary.

Test port return cables used with the network analyzer system must be durable and stable, and care is required to avoid damaging them. Cables can be destroyed by bending with too tight a radius. Because even with careful use, cables wear out eventually, treat all cables as consumable items to be replaced as often as necessary. The most important characteristic of all cables is minimum magnitude and phase change between movements (flexures) of the cable. Replace a cable when unacceptable magnitude and/or phase changes occur when the cable is moved.

The standard recommended cables, in good condition, must be used for detailed performance verification of the analyzer system. These cable sets have low insertion loss, good electrical match, and high return loss, and they are stable in use. For other applications, any high quality cable set can be used.

Extension Lines

External signal path extension lines connected to the test set rear panel EXTENSION A and EXTENSION B connectors are used to balance the reference and test signal path lengths according to the port 1 and port 2 connections to the test device. Balancing the reference and test signal path lengths can be important when making measurements requiring highest accuracy. Signal path balance is less important when using the synthesized sweeper in the step sweep mode.

The extension lines are provided in two lengths: long, which has several loops, and short. Figure 3-7 shows the recommended configuration of these extension lines for the standard coaxial test sets.

Network Analyzer System Description

S-PARAMETER TEST SET

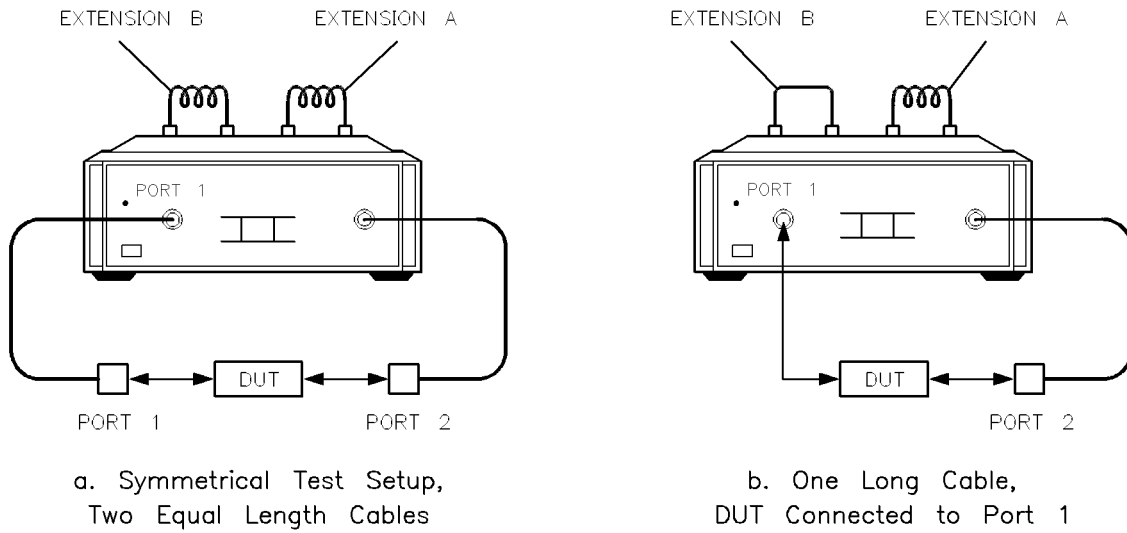

REFLECTION/TRANSMISSION TEST SET

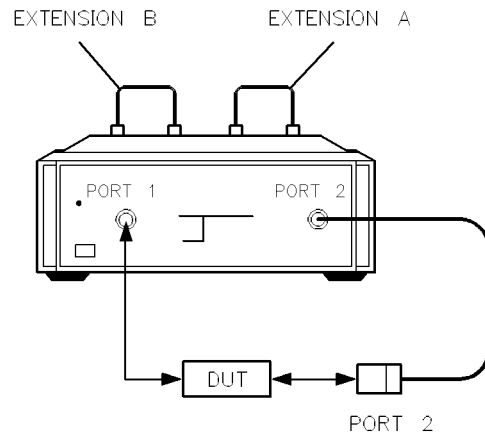

Figure 3-7. Recommended Typical Test Setups

For the reflection/transmission test sets, when connecting the DUT directly to port 1, use the short extension lines. On these test sets, the Extension B line is in the test signal path, making it possible to add bias tees, step or fixed attenuators, amplifiers, isolators, or other signal-conditioning devices.

For the S-parameter test sets, when using a standard test setup with the DUT connected at the ends of the equal length test port extension cables, use the long rear panel extension lines. When connecting the DUT directly at port 1 and using a single transmission return cable, use the short extension line on Extension B.

You may observe the relative signal path length by observing the uncorrected phase response of the short circuit and the thru connections. If non-standard test port extension cables are used, the Extension Lines may be changed to other lengths of high quality cable (low insertion loss, high return loss, stable in use) in order to balance electrical lengths.

Adapters (To Protect Test Ports from Wear)

To preserve the port connectors on the test set, avoid connecting any device under test directly to the test set ports. Always use a high quality adapter or cable as a “connector saver” to avoid damage and wear to the cable connector. Use only high-quality adapters such as those supplied in the Agilent calibration kits. Connect an appropriate cable to the test set port, then connect an adapter that mates to the device under test to the end of this cable.

Proper Connector Care and Use

Keep all connector mating surfaces clean, inspect all connectors visually before every use, and use connector gages to verify that the mating tolerances are within specifications. Always use a calibrated torque wrench, set to the correct torque, when tightening or removing connections.

Calibration Kits

Use only the highest quality calibration standards: devices that have a known response and are stable in use. Only calibration devices that have an accuracy equal to or greater than those in HP calibration kits can provide the calibration and error correction accuracy needed to achieve full, specified measurement accuracy with the 8510 network analyzer system.

Also be aware that calibration standards, like all devices, can become worn and unstable with use. When a calibration device is no longer stable and repeatable, or if it shows signs of connector damage or wear, replace it. Detailed handling and storage instructions appear in the calibration kit operating and service manuals.

A typical calibration kit contains a shielded open circuit, a short circuit, fixed and sliding loads, a connector gage, gage calibration blocks and aligning pins, extra precision 6-slot center collets, a center collet extractor, a connector torque wrench, and a calibration kit definition data cartridge. The calibration kit definition data cartridge contains the nominal characteristics for each of the calibration devices in the kit.

If you use other than a standard Agilent calibration kit, you can define the standard's nominal characteristics from the analyzer front panel using the **MODIFY CAL SET** feature explained “Modifying A Calibration Set,” at the end of Chapter 8. After you define the calibration kit standards, you can store the data on disc and reload the data as required.

Network Analyzer System Description

Verification Kits

Performance verification standards are used to determine that the system can be calibrated and can produce good measurement results. Devices in the verification kits are precision devices that should not be used on a day-to-day basis. These devices have been characterized on a standards-class network analyzer by experienced Agilent personnel. If you use proper calibration and measurement techniques, your measurement results should be comparable to the data supplied with the devices, within the system specifications. The typical Agilent verification kit includes fixed attenuators, a beadless air line, and a beadless, stepped-impedance, two-port air line mismatch standard. Data for the devices includes a device data sheet that lists traceable fully error-corrected data and measurement uncertainty data on all devices in the kit at various specified frequencies. This measurement uncertainty includes both the uncertainty of the Agilent measurement system and the specified uncertainty of the recommended test system.

For detailed system performance verification instructions, refer to Chapter 8, “Specifications and Performance Verification,” in the *Agilent 8510C On-Site Service Manual*.

For information concerning the use and care of the test set, test cables, adapters, calibration kits, and verification kits, refer to their respective manuals. These are supplied with your system.

Automatic Recall of Instrument Settings

The receiver remembers most measurement settings when you switch back and forth between channels, domains, parameters, or display formats. (This feature remembers all measurement settings *except* stimulus settings.) This feature is automatic, and does not require you to use the Save or Recall functions. The feature is called “limited instrument state memory.”

Limited instrument state memory works by assigning a hierarchy to the instrument settings. The hierarchy is as follows:

- Channel (1 or 2)
- Domain (Frequency, Time, or Power)
- Parameter (1, 2, 3, or 4)
- Format (any display format)
- Response (scale and reference line)

Every mode in the above list *remembers* all settings you make that are *lower in the hierarchy*. For example, assume you choose the following measurement settings.

- Channel 1
- Power Domain
- Parameter 3
- Log mag (format)
- Reference –10 dB
- Scale 5 dB/div

Now you go to Channel 2 and make completely different settings.

When you go back to Channel 1, the settings shown above automatically resume. This hierarchical memory applies to all the controls in the above list.

The Added Benefit of the SAVE/RECALL Feature

Stimulus settings are not part of the limited instrument state memory explained above. To save stimulus settings along with all the other settings, you must use the SAVE/RECALL feature. Two other advantages of the Save/Recall feature are:

- Saved instrument states can be stored to disc.
- Instrument states saved to Save/Recall register 8 becomes the default power-ON or User Preset state.

Factory Preset State

Factory Preset State

The Factory Preset State consists of the factory default values selected for various functions. The following table lists the preset state or value associated with a function. If you have a question about a specific function, refer to its individual entry in the *Agilent 8510C Keyword Dictionary*.

Table 3-1. Factory Preset Conditions for the 8510C

CAL	CORRECTION OFF, Z ₀ = 50Ω, PORT EXTENSIONS 1 and 2 = 0 seconds, VELOCITY FACTOR = 1.0, TRIM SWEEP = 0, CAL SETS 1-8 = Not Changed
DOMAIN	FREQUENCY DOMAIN GATE OFF
DISPLAY	SINGLE CHANNEL, DATA Trace Memories 1-8 Not Changed Display Colors Not Changed Date/Time Clock On
MARKER	all OFF, Δ OFF, DISCRETE Marker List On, 1 Marker per Parameter
STIMULUS	Maximum sweep range of source and test set NUMBER OF POINTS = 201, Source Power = depends upon the source Test Set Attenuation = 0 dB, SWEEP TIME = 166 ms, RAMP SWEEP, CONTINUAL, COUPLED CHANNELS
PARAMETER	Channel 1 = S ₁₁ , Channel 2 = S ₂₁
FORMAT	Channel 1 = LOG MAG. Channel 2 = LOG MAG
RESPONSE	SCALE = 10 dB/division, REF VALUE = 0 dB, REF POSN = 5, ELECTRICAL DELAY = 0 seconds, COAXIAL, AVERAGING = OFF, SMOOTHING = OFF, PHASE OFFSET = 0 degrees, MAGNITUDE OFFSET = 0 dB, MAGNITUDE SLOPE = 0 dB/GHz
INSTRUMENT STATE	Selected Channel = 1, No Menu Displayed SAVE/RECALL Instrument States 1-8 Not Changed.
COPY	PLOT ALL = FULL PAGE S ₁₁ Data = Pen 3 S ₂₁ = Pen 5 Plot Type = Color
SYSTEM	GPIB Addresses Not Changed LCD/CRT ON, IF GAIN = AUTO MULTIPLE SOURCE = OFF

Hardware State

In general, the Hardware State functions are those that are required for proper operation at power up and relate more to the hardware configuration of the analyzer. These functions are not affected by pressing either **USER PRESET** or **FACTORY PRESET**. Values or text shown in parenthesis are factory default settings.

Table 3-2.

Hardware State	Setting
GPIB Addresses	ADDRESS of 8510 (16)
	ADDRESS of SYSTEM BUS (17)
	ADDRESS of SOURCE #1 (19)
	ADDRESS of TEST SET (20)
	ADDRESS of PLOTTER (GPIB, 5)
	ADDRESS of PRINTER (GPIB, 1)
	ADDRESS of DISC (0)
	ADDRESS of SOURCE #2 (31)
	ADDRESS of PASS-THRU (31)
	ADDRESS of RF SWITCH (31)
	ADDRESS of POWERMETER (13)
Disc Unit Number (0)	
Disk Volume Number (0)	
System Phaselock Type (Internal)	
System Phaselock Speed (Normal)	
System Phaselock Step Type (Reads Source in System to Determine)	
Multiple Source Values	<ul style="list-style-type: none"> ■ RF Source #1 <ul style="list-style-type: none"> Numerator (1) Denominator (1) Offset (0) ■ LO Source #2 <ul style="list-style-type: none"> Numerator (0) Denominator (1) Offset (0) ■ Receiver <ul style="list-style-type: none"> Numerator (1) Denominator (1) Offset (0)
GPIB Response to PRES; Command (User Preset)	
Warning Beeper (On)	
Power Level RF Source #1 (0 dBm)	
Power Level LO Source #2 (0 dBm)	

Factory Preset State

Table 3-2. (continued)

Hardware State	Setting
LCD/CRT Display Colors	Background Intensity (0%) Softkeys (Bright White) Warnings (Bright Red) S ₁₁ Data (Bright Yellow) S ₂₂ Data (Bright Green) S ₂₁ Data (Bright Cyan) S ₁₂ Data (Bright Salmon) Graticule (Dim Grey) Marker Symbols (White) S ₁₁ Memory (Medium Yellow) S ₂₂ Memory (Medium Green) S ₂₁ Memory (Medium Cyan) S ₁₂ Memory (Medium Salmon) Stimulus Values (Medium White)
External Video Synchronization (Sync on Green, Negative)	
Power Leveling	Source 1 (internal) Source 2 (internal)

Measurement Controls

Measurement controls include the following menu blocks and front-panel keys, which are described in this chapter in the following alphabetical order:

- Display
- Domain
- Marker
- Parameter
- Response
- Stimulus

Display

Press the **DISPLAY** key in the MENUS block to bring the Display menu onto the CRT/LCD.

Note The original 85101 (top box) of 8510 systems incorporated a cathode ray tube (CRT) based display. The current design incorporates a liquid crystal display (LCD). Display references apply to both designs unless noted otherwise.

Choices under the Display menu allow you to choose:

- Single channel, single parameter, or
- Single channel, four parameter, or
- Dual channel displays.
- The color attributes of the CRT/LCD.
- External video interface selections (CRT only).
- Limit lines and limit point measurements.
- Storage (to memory) and display of complete traces.
- Complex trace math using the current data and a trace stored in memory or the current data from either channel.

DISPLAY Functions

Display Modes

The display mode menu is shown in Figure 4-1.

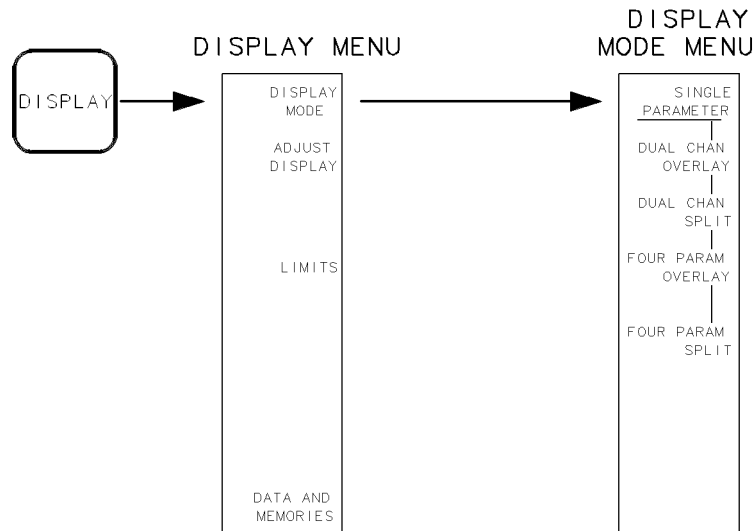

Figure 4-1. Display and Display Mode Menus

Figure 4-2 shows one possible LCD/CRT display and its annotation areas. Figure 4-3 shows the annotation areas for the four parameter split display mode.

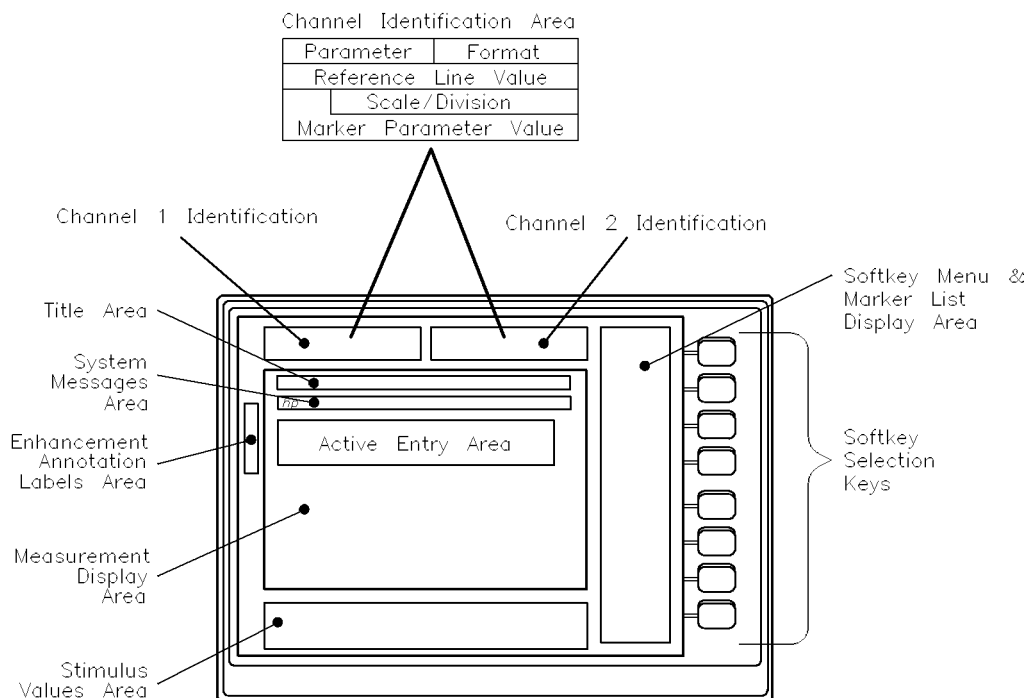

Figure 4-2. Annotation Areas for Single Parameter or Dual Channel Display Mode

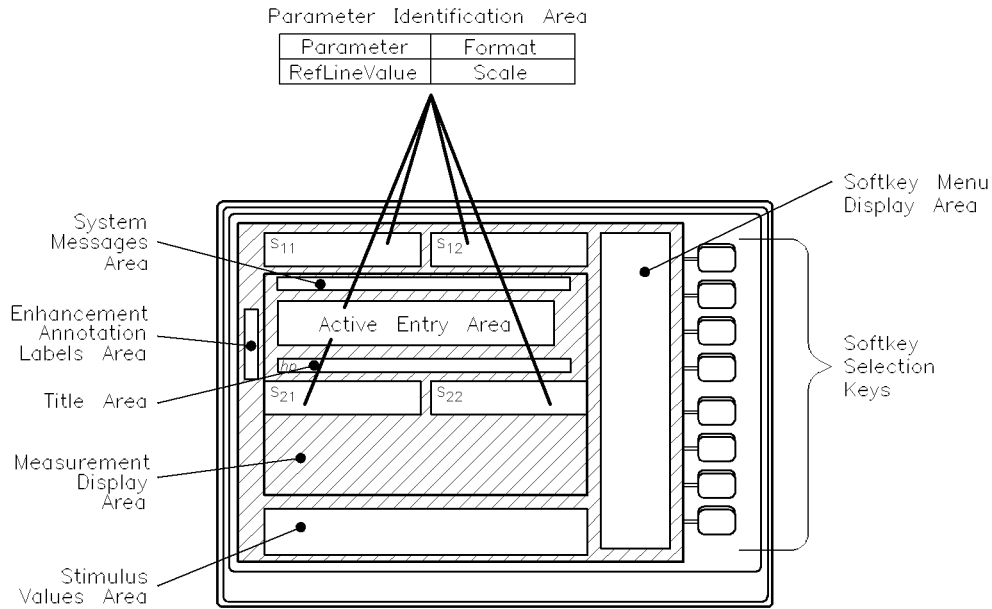

Figure 4-3. Annotation Areas for Four Parameter Split Display Mode

The annotation areas are explained in Chapter 1, “Principles of Operation.” Note that the following annotation areas stay in the same location regardless of the display mode.

- | | |
|------------------------|---------------------|
| Active Entry | System Messages |
| Enhancement Annotation | Stimulus Values |
| Softkey Menu Display | Measurement Display |

SINGLE PARAMETER is the Factory Preset state, with channel 1 displaying S₁₁.

Dual Channel Display Modes

In dual channel operation, the current channel 1 and channel 2 measurements are displayed at the same time.

- **DUAL CHAN OVERLAY** displays both measurements full size on the format selected for each channel. A dual channel overlay trace showing Log Mag for both channels is shown in Figure 4-4, although any parameter, format, and response settings can be selected for either channel. For Cartesian displays, trace labels identify the traces for the two channels: the label 1 (identifying the trace from channel 1) appears on the left of the graticule; the label 2 (channel 2) appears on the right of the graticule.
- **DUAL CHAN SPLIT** displays the measurements on two half-size graticules side by side. Channel 1 measurements are on the left, channel 2 measurements on the right.

DISPLAY Functions

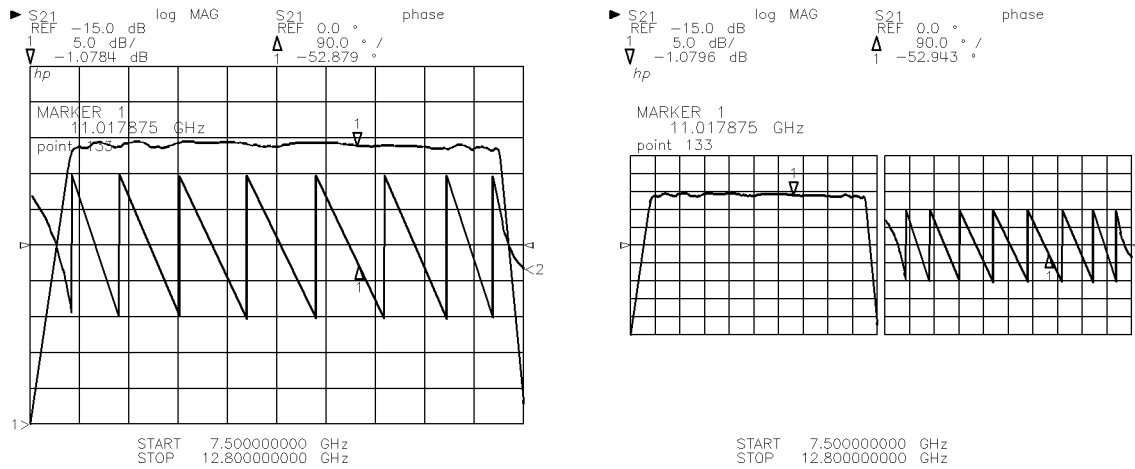

Figure 4-4. Dual Channel Overlay and Split Displays

Operation in dual channel is the same as for single channel. To change the measurement setup, first select the channel, press **CHANNEL 1** or **CHANNEL 2**, then make the control settings. The Parameter, Format, and Response functions are selected independently for each channel. If you want to choose different Stimulus functions for each channel, you must first “uncouple” the channels by pressing **STIMULUS** **MENU** **MORE** **UNCOUPLED CHANNELS** (see Stimulus for details).

To return to a single-channel display, press **DISPLAY**, **DISPLAY MODE** **SINGLE PARAMETER**.

Single Channel, Four Parameter Display Modes

Four parameter display modes are useful for viewing all four S-parameters or a combination of S-parameters with User parameters at the same time.

FOUR PARAM OVERLAY displays all four parameters full size in the format selected for each parameter. In four parameter overlay display mode, information for all four parameters appears at the top of the display in the following format:

S ₁₁	DISPLAY FORMAT	S ₁₂	DISPLAY FORMAT
REFERENCE LINE VALUE	SCALE	REFERENCE LINE VALUE	SCALE
S ₂₁	DISPLAY FORMAT	S ₂₂	DISPLAY FORMAT
REFERENCE LINE VALUE	SCALE	REFERENCE LINE VALUE	SCALE

User parameters are shown in the following locations:

USER 1	DISPLAY FORMAT	USER 3	DISPLAY FORMAT
REFERENCE LINE VALUE	SCALE	REFERENCE LINE VALUE	SCALE
USER 2	DISPLAY FORMAT	USER 4	DISPLAY FORMAT
REFERENCE LINE VALUE	SCALE	REFERENCE LINE VALUE	SCALE

FOUR PARAM SPLIT displays all four parameters in four quarter-sized graticules. In the four parameter split display mode (Figure 4-3), parameter identification information appears directly above the respective trace display.

Adjust Display Menu

In this menu, you can modify the visual characteristics of the display, including its intensity, and colors.

Note The original 85101 (top box) of 8510 systems incorporated a cathode ray tube (CRT) based display. The current design incorporates a liquid crystal display (LCD). Display references apply to both designs unless noted otherwise.

Intensity

To change the overall display intensity press, **DISPLAY MORE ADJUST DISPLAY** and **INTENSITY**. Use the RPG knob or entry keys to enter the intensity value desired. Terminate entries with the **[X1]** key.

- For a CRT display, the factory default setting is set to 83%. This setting maximizes display life.
- For an LCD, the factory default setting is set to 100%. It can be adjusted from 100% to 50%.

DISPLAY Functions

The intensity level cannot be saved/recalled. It remains as set or returns to the factory default.

Background Intensity (CRT only)

Background intensity can be changed to any value from 0 to 100%. The factory set value is zero, to offer the greatest contrast with the intensity level. Background intensity can be saved/recalled.

Modify colors

The displayed colors can be changed to any of sixteen different colors, saved, and recalled. See Figure 4-5 for the adjust display menu.

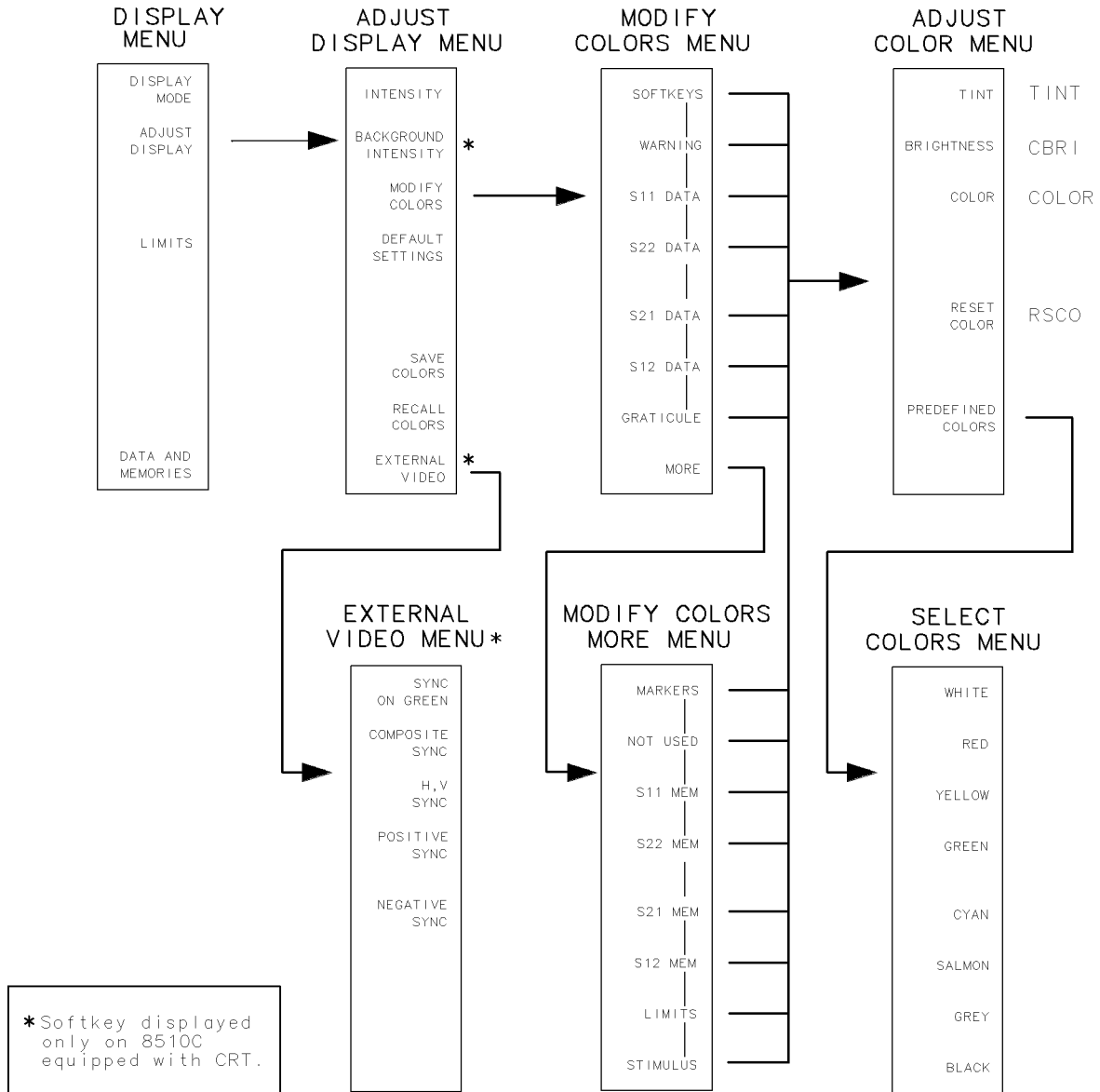

adjdisp

Figure 4-5. Adjust Display Menu

The following sequence of steps demonstrates how to change, save, and recall the colors for the displayed elements.

1. Press **DISPLAY** **ADJUST DISPLAY** **MODIFY COLORS**. This keystroke sequence displays page one of the modify colors menu.
2. Choose one of the various display elements shown on the menu. For example, press **MORE** **STIMULUS**. By selecting the stimulus element, you have actually chosen to modify the color assigned to the stimulus value notation shown on the display. Now you can adjust the tint, brightness, and color saturation for that color. The tint, brightness, and color default settings vary with the display element/color selected.

DISPLAY Functions

- a. Press **BRIGHTNESS**. Use the knob to vary the intensity of the color from very dim (cannot be seen at 0%) to very bright (100%).
- b. Press **COLOR**. Use the knob to vary the color saturation of the the color from white (0%) to all color (100%).
- c. Press **TINT**. Tint is the continuum of hues on the color wheel, ranging from red, through green and blue, and back to red.

The tint setting for the primary colors is as follows:

yellow = 14
 blue (cyan) = 53
 red = 0

3. The **RESET COLOR** softkey returns the display element/color to the default color definition for that color.
4. Press **PREDEFINED COLORS** to display the menu of colors with predefined definitions for tint, brightness, and color.
5. Choose one of the predefined colors, for example **GREEN**. The display element/color turns green and the last active function, tint value in this case, is shown.
6. To save the color modifications you have made, press **PRIOR MENU** as many times as necessary to return to the adjust display menu or press **DISPLAY** **ADJUST DISPLAY**. Now press **SAVE COLORS**.
7. To recall a previously saved color scheme, press **RECALL COLORS**.

Default Colors

The **DEFAULT COLORS** softkey returns the display attributes to their factory set default colors and background intensity. The following is a partial list of the default color definitions.

Table 4-1. Default Settings for Display Elements

Display Element	Color	Tint	Brightness %	Color %
SOFTKEYS	white	0	100	0
WARNING	red	0	100	100
S ₁₁ DATA	yellow	14	100	100
S ₂₂ DATA	green	38	93	100
S ₂₁ DATA	cyan (blue)	53	100	60
S ₁₂ DATA	salmon	0	100	36
GRATICULE	grey	0	49	0
MARKERS	white	0	80	0
S ₁₁ MEM	mustard (yellow)	11	70	85
S ₂₂ MEM	green	41	63	85
S ₂₁ MEM	lt. cyan (blue)	60	70	60
S ₁₂ MEM	lt. red	0	75	55
STIMULUS	white	0	90	0

External Video (CRT only)

The network analyzer is designed to work with external video monitors. Use the controls in the following menu to configure the system for compatibility with a variety of monitors. To evaluate a display for analyzer compatibility, look for a horizontal scan range that includes 25.5 kHz. None of these controls affect the internal CRT.

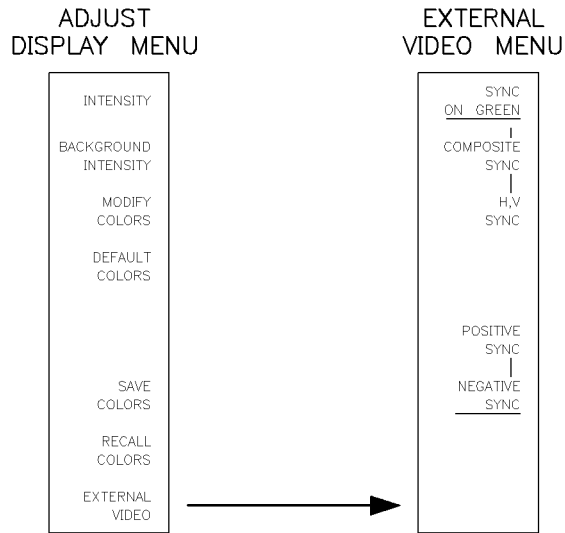

Figure 4-6. External Video Menu

The external video connections are made available through the D1191A external video cable, provided with your analyzer system. Connect the cable to the rear-panel EXTERNAL DISPLAY multi-pin connector. Refer to Table 4-2.

To use the analyzer with an HP 35741 or 35742 external monitor, match and connect the red, green, blue BNC cables and then check the analyzer external video settings for sync-on-green mode. This synchronization method superimposes the combined horizontal and vertical sync signals onto the green (analog) video signal. This is done in a manner similar to EIA standard RS-330 (positive video, negative sync). This is the factory default setting, but once modified, the new settings are retained in EEPROM and are not modified by **FACTORY PRESET** or by recalling an Instrument State.

Use **COMPOSITE SYNC** when the external display device requires a TTL-level composite sync. To some external display devices, the polarity of the synchronization signal is significant. The composite signal may be either positive or negative logic.

Use horizontal, vertical sync when an external display device requires separate TTL-compatible synchronization signals. After selecting **H,V SYNC**, check and set, if necessary, the polarity of the synchronization signal.

Use **NEGATIVE SYNC** when an external display device requires negative logic, TTL-compatible synchronization.

Use **POSITIVE SYNC** when an external display device requires positive logic, TTL-compatible synchronization.

DISPLAY Functions

Table 4-2. External Display Cable Connections

Mode	BNC Cable Signal	
	Red Green Blue	Sync
SYNC ON GREEN	R G B	on green/white BNC
COMPOSITE SYNC	R G B	on black/white BNC
H, V SYNC	R G B	horizontal (H) on black/white BNC vertical (V) on brown/white BNC

External Video (LCD only)

Network analyzers with a liquid crystal display (LCD) installed are designed to work with external VGA video monitors. The external video connections are made available through the rear-panel VGA multi-pin connector.

Limits: Limit Lines and Limit Points Measurements

On the 8510C network analyzer, you can define limits that are displayed on the screen, while the trace is displayed. These limits allow you to visually compare the trace values with the limits that are defined.

In addition to the limits display on the screen, you can select to have the 8510C perform a numeric PASS/FAIL comparison with the defined limits. The comparison will indicate whether the current trace meets the user-defined limits. PASS appears if the trace meets the defined limits, or FAIL appears if the trace exceeds the defined limits.

Types of Limits

There are two limit types:

Limit Lines This type of limit consists of two end points with a line drawn between the end points. The end points of the line are defined by a stimulus value, usually a frequency, and a limit value. The limit line drawn between the two end points may be either flat or sloping, depending upon the end point settings. Make certain that you enter an end-point value that is greater than the begin-point value.

Limit Points This type of limit consists of a single point, having a single stimulus value and limit value. A limit point is drawn on the display as \wedge symbol. The sharp point in the \wedge indicates the position of the limit point.

Limit Testing

For the purpose of limit PASS/FAIL testing, limit lines and points may be defined as being either “upper” (maximum) limits, or “lower” (minimum) limits. When limit PASS/FAIL testing is turned on, the measurement points that are on-screen, and fall within any defined limits, are tested. Either a PASS or FAIL message is displayed relating to the results of the test.

For limit lines, keep in mind that only data points that are *actually measured* are tested against the limits. For example, a limit line could end between two measurement points. If this happens, the end point of the limit line is *not* tested.

Note For limit lines, only the measurement points that fall between the limit line end points are tested.

For limit points, if the limit point does not fall exactly on a measurement point, then the nearest actual measurement point is used for the limit PASS/FAIL test. In addition, any limit point that is not in the measurement range (off the edge of the display), of course, is not tested.

When no limits are defined, turning limit testing ON displays a PASS message. Any limits that are defined, but are not in the current measurement range (they are off the edge of the display), are also not tested.

If desired, limit PASS/FAIL may be turned on without limits being displayed.

DISPLAY Functions

Limit Tables

Each limit table can consist of from 0 to 12 limits, in any combination of limit lines and limit points.

An instrument state in the 8510C can contain eight limit tables. There are four tables for each channel, and one table for each of the four “primary” parameters (one each for S11, S21, S12, and S22, but the same limit table is used for S11 and User 1.) By having multiple limit tables, separate tables of limits may be defined for each parameter while in 4-parameter display mode.

After a limit table has been created for one parameter on one channel, that table may be copied to any other parameter on either of the channels, using the **COPY LIMITS** function.

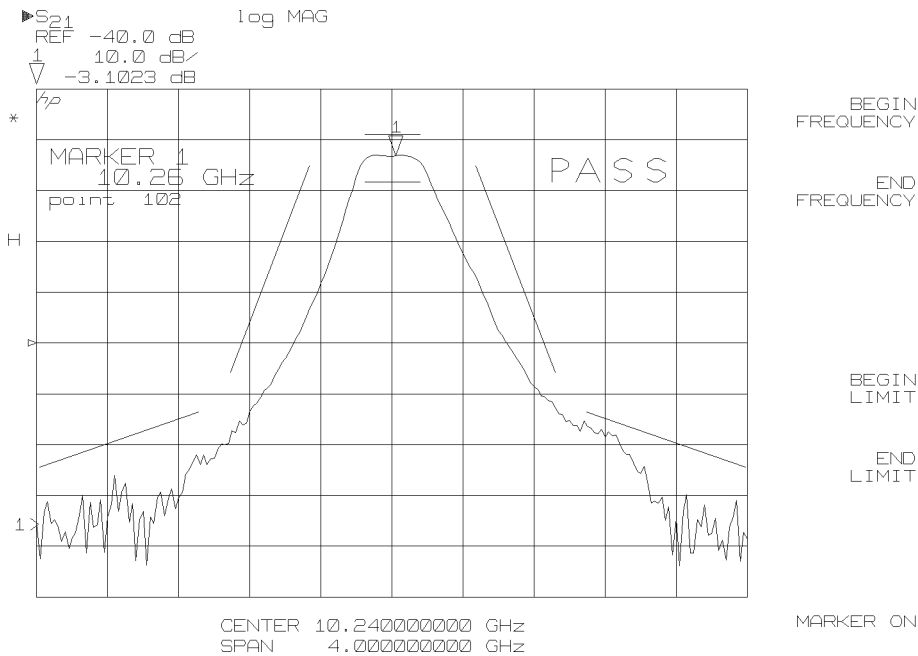

Figure 4-7. Example of a Limit Test using Limit Lines

Creating a Limit Test

Use the following example to set up an example limit test for an RF filter.

Note This procedure assumes a device response is displayed on the network analyzer screen.

To Set Up the Measurement

1. Connect the RF filter between the network analyzer RF OUT and RF IN ports.
2. Press **(PRESET)**, **(FREQ)**, then **(CENTER)**. Enter the center frequency of the RF filter being tested.

For this example, enter 175 MHz for the center frequency.

3. Press **SPAN** and enter a frequency span that simplifies viewing the passband of the RF filter.

Use a 200 MHz span, as an example.

4. Press **SCALE** then **AUTOSCALE** to view the entire measurement trace.

To Set the Limit Test Values

Limits create boundaries between which an active trace must remain for the measurement to pass. To develop the limits, you select an appropriate softkey and adjust its position (value) with the RPG, the step keys, or by entering the numeric value via the key pad.

5. Press **DISPLAY** then **LIMITS**. The network analyzer display splits into two sections. One section displays the limit table and the other shows the selected limits on the display.
6. Press **ADD LIMIT** to display the Add Limit menu.

To Define the Maximum Limit

In the following example, the response of the filter is measured against three maximum limit lines. The values are determined from the displayed trace, then limit parameters are entered for a limit test. The values used for determining the limits are as follows:

Location	Frequency of Interest
The low side of the cut-off frequency portion	125 MHz to 150 MHz
The bandpass portion	155 MHz to 195 MHz
The high-side of the cut-off frequency portion	200 MHz to 225 MHz

There are two ways to define the test limits:

1. Use a marker to determine the frequencies of the trace you plan to limit test:
 - Press **MARKER**.
 - Use the RPG knob to move the marker along the trace, or use the **= MARKER** key to enter values directly.
2. Or, use the softkeys and the RPG, step keys, or numeric keys in any combination to visually adjust the limits in real-time, about the displayed measurement trace.
 - a. Press **ADD MAX LINE** to set a limit above the device's response trace.
 - b. Press **BEGIN STIMULUS**, then enter 125 MHz. This is the beginning frequency value of the first, maximum limit line.

DISPLAY Functions

Note

Correct a mistake by using the following technique:

- If your incorrect value is entered and you have not pressed **MHz**, back space over the error, then enter the correct value.
 - If you have pressed **MHz** for the incorrect value, press **BEGIN STIMULUS** and enter the corrected value.
-

- c. Press **END STIMULUS**. Enter 150 MHz, the ending frequency of the first maximum limit line. A limit line is drawn between the two frequency values you entered, at a zero (0.0) unit level.
 - d. Press **BEGIN LIMIT** and watch the limit segment and measurement trace as you rotate the RPG knob to adjust the beginning of the limit segment.
 - e. Place the beginning of the limit line at -25 dB, which is the device's maximum allowable output power level, for the beginning frequency.
-

Note

Notice that the power level and frequency value appear in the limit-test table. You can iterate between setting the beginning and ending of the limit line position.

- f. Press **END LIMIT**, and watch the traces on the display as you rotate the RPG to adjust the end of the limit segment.
 - g. Place the end of the limit line at 0.0 dB, which is the device's maximum allowable output power level, for the ending frequency.
3. Press **PRIOR MENU**, then **ADD MAX LINE**. Repeat the above steps for the frequencies of the second and third maximum limit lines. For this example:
 - 1) 155 MHz to 195 MHz, and 2) 200 MHz to 225 MHz

To Define Minimum Limit Lines

If desired, use the RPG, step keys, or numeric keypad to define minimum limits. Minimum limits may be at frequencies that are different from the maximum limit frequencies. It is acceptable to enter minimum limits before or after entering maximum limits.

For this example, the frequencies used for maximum and minimum limit lines are slightly different. Refer to the table below:

Location	Frequency of Interest
The low side of the cut-off frequency portion	125 MHz to 150 MHz
The bandpass portion	155 MHz to 195 MHz
The high-side of the cut-off frequency portion	200 MHz to 225 MHz

1. Press **PRIOR MENU**, then **ADD MIN LINE** to set up the limit line for the device's lower level response.
2. Press **BEGIN STIMULUS** and enter 125 MHz, the beginning frequency of the first minimum limit line.

Note Correct a mistake by using the following technique:

- If your incorrect value is entered and you have not pressed **MHz**, back space over the error, then enter the correct value.
- If you have pressed **MHz** for the incorrect value, press **BEGIN STIMULUS** and enter the corrected value.

3. Press **END STIMULUS**. Enter 150 MHz, the ending frequency of the first minimum limit line. A limit line is drawn between the two frequency values you entered, at a zero (0.0) unit level.
4. Press **BEGIN LIMIT** and watch the limit segment and measurement trace as you rotate the RPG knob to adjust the limit segment.
5. Place the beginning of the limit line at -50 dB, which is the device's minimum allowable output power level for the beginning frequency.

Note Notice that the power level and frequency value appear in the limit-test table. You can iterate between setting the beginning and ending of the limit line position.

6. Press **END LIMIT** and rotate the RPG to position the end of the limit line at -10 dB, the device's minimum allowable output power level for the ending frequency.
7. Press **PRIOR MENU**, then **ADD MIN LINE** and repeat the steps above for the second and third minimum limit lines. For this example,
 - 1) 155 MHz to 195 MHz, and 2) 200 MHz to 225 MHz

DISPLAY Functions

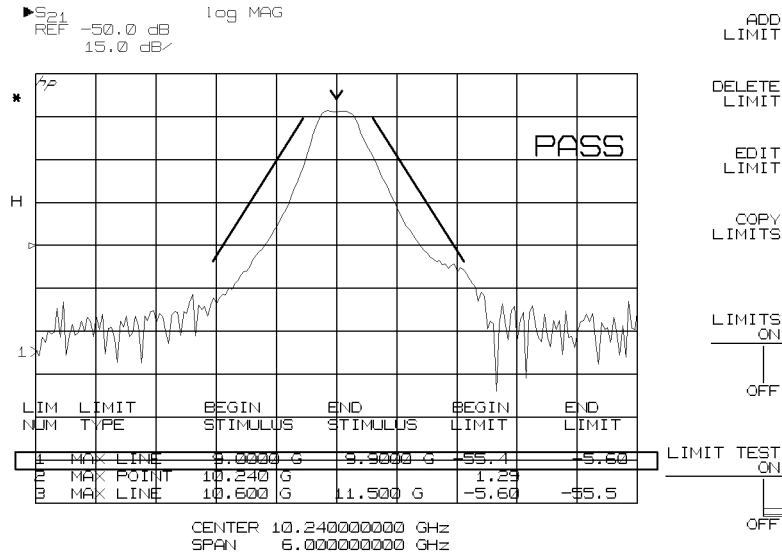

Figure 4-8. Limit Test Example Using Limit Lines and Limit Points

Editing Limits in the Limits Table

You may edit any individual frequency, limit, or limit line after you have created it. Become familiar with the information below about modifying a limit value:

1. Press **DISPLAY**, then **LIMITS**. The display shows the test device response with limit lines and the tabular listing of the limits set. The highlighted box surrounding one segment indicates the currently selected limit for editing.
2. Press the arrow keys or use the RPG to move the highlighted box to the portion of the test parameter to edit.
3. Press **EDIT LIMITS**, then press the keys that correspond to the portions of the limit you want to edit (begin frequency, end frequency, begin limit, or end limit, as an example).
4. Enter new limit values.
5. Press **PRIOR MENU** to return to the limits menu.
6. Press **LIMIT TEST ON** to activate the limit test with the new limits. Test results are displayed on the screen as **PASS** or **FAIL**.

Trace Memory Operations

You can store a response in one of the eight trace memory locations, then compare the data with the current measurement trace, in any format. The Display menu provides softkeys so you can show the data and memory traces individually, or simultaneously. The **DATA AND MEMORIES** softkey displays the menu to use.

In both single- and dual-channel modes, the display data, memory, and trace math operations are always uncoupled. You may select memory operations independently for each channel.

Storing Trace Data in Memory

Press the **DISPLAY** key in the MENUS block. The factory preset condition selects **DISPLAY: DATA** for both Channel 1 and Channel 2. This setting displays the trace from the current trace data.

To store the active trace in memory, press **DATA → MEMORY_n** (where *n* represents the memory location number, 1 through 8). After a factory preset, each channel is assigned a separate memory. The current channel selection for the memory is indicated by the number in the softkey label, **DATA → MEMORY n**.

To Display a Stored Trace

To display the stored (memory) trace only, press **DISPLAY: MEMORY**. Notice that when the memory trace is displayed, the numeric trace indicator for the Cartesian display (a 1 for channel 1 or a 2 for channel 2) disappears. In addition, the sweep is stopped. The parameter label located in the channel identification area changes to indicate which memory register is being displayed.

Settings that can and cannot be changed. You may select any format and response setting to display the stored trace. The STIMULUS menu **START** and **STOP** key functions are not active. The marker can be used to read the power and frequency values of the memory trace.

To Display Data and Memory Simultaneously

Press **DATA AND MEMORIES**, then press the **DATA and MEMORY** key. The two traces are displayed in the same grid. The two traces use the same scale per division, reference line value, and reference line position that was used for the selected data trace. The parameter label in the channel identification area changes to name the parameter and the memory that is displayed.

Notice the current data trace is annotated with either a 1 or a 2 at the end of the trace. The memory trace, however is not annotated. The marker reads only the current data trace.

Settings that can and cannot be changed. The stored trace must be viewed in the same domain (frequency, time, voltage, or power) as which the data was stored. Changing the instrument domain before retrieving the data cannot change the data's domain. The same number of frequency points must also be used. If the domain or number of points is changed prior to retrieving the data, the current memory operation is automatically turned OFF, and **DISPLAY: DATA** is selected.

DISPLAY Functions

Most other display details, however, can be the ones chosen for the currently displayed trace because of the following methodology:

- Data is transferred to memory after error correction is performed.
- Data is transferred to memory after electrical delay is applied.
- Data is transferred to memory after time domain conversion is completed.
- Data is transferred to memory prior to trace-math operations.

Refer to Figure 3-3, “Digital Signal Processing” diagram, for a better look at which operations are a part of the stored trace data.

To Select the Default Memory

Refer to Figure 4-9. On the far, left-hand side is the Display menu. Press the **DATA AND MEMORIES** key. Use the **SELECT DEFAULTS** key to change the **DATA → MEMORY 1** to be any one of eight memory locations. The number in the softkey reflects the default memory location you choose.

If you are using Channel 2, the softkey changes to **DATA → MEMORY 2**. Again, any of the other eight memory locations may be selected. Figure 4-9 illustrates the menus available for the memory operations.

The default settings after a factory preset are as follows:

- Data for Channel 1 is saved in memory register 1.
- Data for Channel 2 is saved in memory register 2.

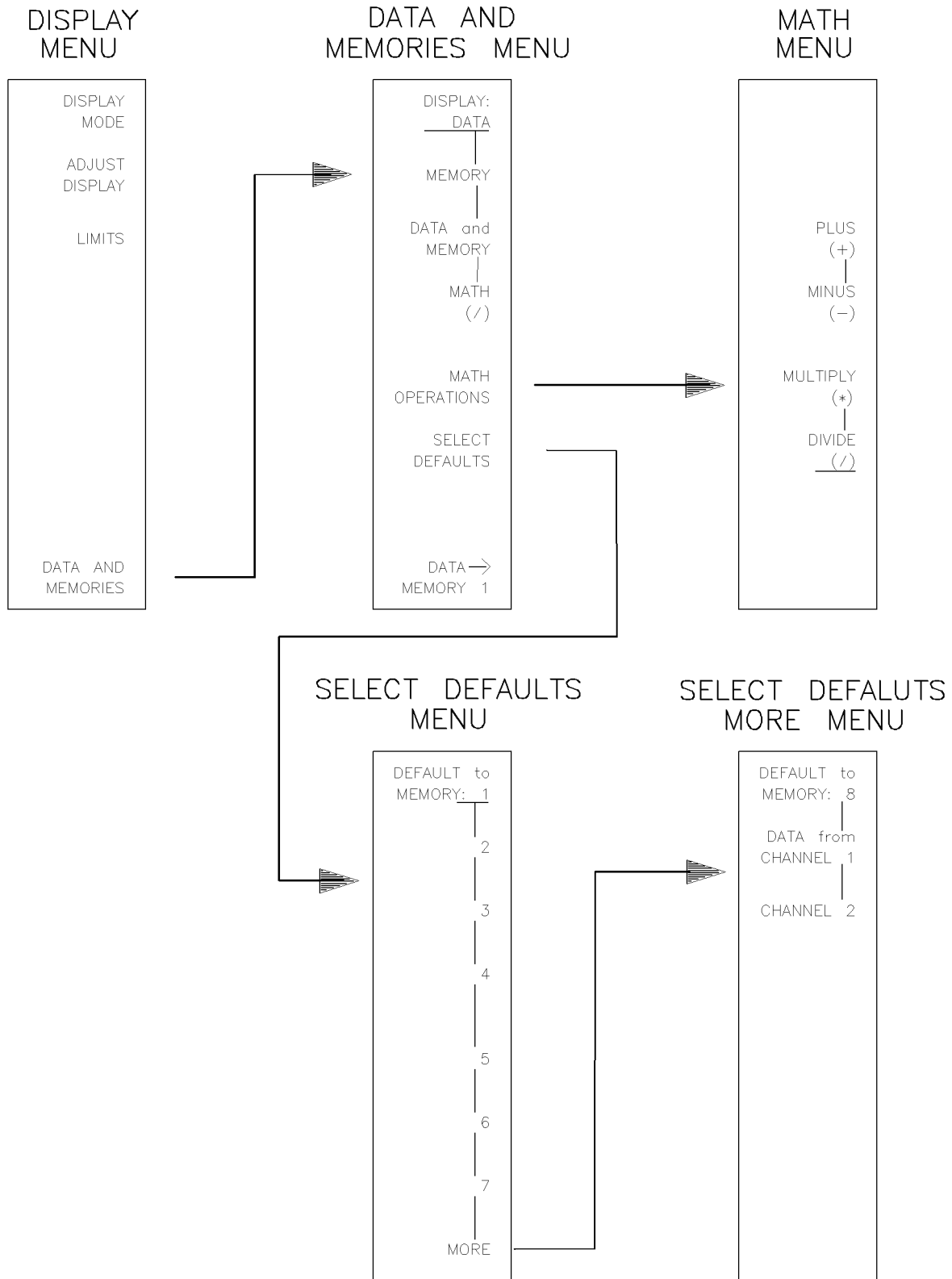

Figure 4-9. Display Menu Showing Trace Memory Locations Menu

DISPLAY Functions

Refer to the following steps to select a memory location:

1. Select either **CHANNEL 1** or **CHANNEL 2**.
2. Press **DISPLAY**, then press **DATA AND MEMORIES**.
3. Press **SELECT DEFAULTS**. Notice that the currently selected memory register is underlined.
4. Press the key beside the memory register (**1** through **7**, then **MORE** for **8**) to underline a different default memory register.
5. To leave the setting unchanged, press **PRIOR MENU**.

Which memory locations are volatile, which are not. The Display menu reappears after pressing a **DEFAULT to MEMORY n** (where n represents a number 1 through 8). Memory locations 1, 2, 3, or 4 are non-volatile memory locations. Therefore, the contents are retained after an instrument power cycle.

If memory locations 5, 6, 7, or 8 are displayed, these are volatile registers. The contents of these registers are purged after an instrument power cycle.

What is the operational life of non-volatile memory. In addition, memory locations 1, 2, 3, and 4 use a solid-state memory type that can fail after a number of **DATA → MEMORY** operations are used. The quantity is more than 10,000 operations, however. In view of this factor, use memory registers 5, 6, 7, and 8 rather than 1, 2, 3, and 4 for repetitive memory operations.

Trace Math Operations

The trace math operations provide functionality for complicated mathematical calculations such as:

- Vector addition
- Vector subtraction
- Vector multiplication
- Vector division

You can use these functions on the data trace, using a selected memory, or in dual channel operation, from the opposite channel. Following a factory preset sequence, the default math operation for both channels is **MATH (/)**. This function provides a display showing the ratio between the current trace and the stored trace. Notice that the parameter label in the channel identification area changes to show the math operation is being performed. The equivalent equation for this display is as shown:

$$\frac{\text{current trace (DATA)}}{\text{stored trace (MEMORY)}}$$

If the current trace and the stored trace are identical, the complex ration between them is one, and a Cartesian display of the result would be a flat line at 0 dB°, or seconds.

Complex math operations are performed on real and imaginary data, from the corrected data array for the selected channel. Data is processed by the math function *before* display formatting and therefore, the results may be viewed in any format. Refer to the following steps for an example of changing the default trace-math function:

1. Select either **CHANNEL 1** or **CHANNEL 2**.
2. Press **DISPLAY**, then press **DATA AND MEMORIES**.
3. Press **MATH OPERATIONS** and choose the operation you want to become the default setting.

4. Press **PRIOR MENU** to retain the original setting.

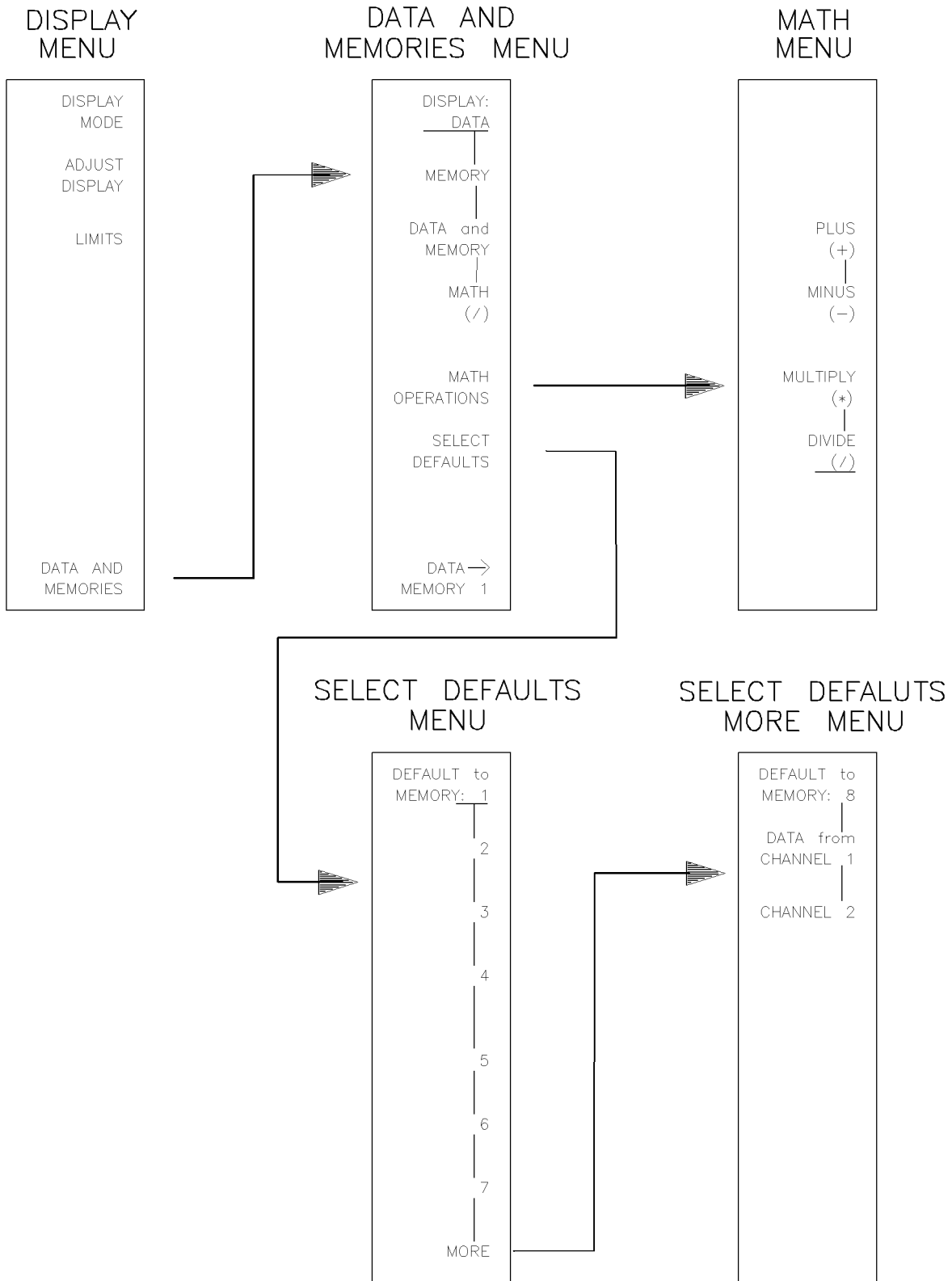

Figure 4-10. Trace Math Operations Menu Structure

DISPLAY Functions

Data from Channel 1 and Data from Channel 2

The **DATA from CHANNEL 1** and **DATA from CHANNEL 2** keys allow comparison of the current data from one channel with current data from the other channel. An example of this procedure follows:

1. Press **CHANNEL 2** and in the Parameters block, press **S11**.
2. Press **DISPLAY**, then press **DISPLAY MODE**.
3. Press **DUAL CHAN SPLIT** to display two graticules side-by-side.
4. Press **CHANNEL 1**, **PRIOR MENU** and from the Display menu, press **DATA AND MEMORIES**.
5. Press **SELECT DEFAULTS**, **MORE**, then **DATA CHANNEL 2**.
6. Press **MATH (/)** to display on Channel 1 the complex ratio of channel 1 current data divided by channel 2 current data.

Note Although the feature was intended for dual-channel operations, if a channel 1, single-channel display, is now selected, the last acquired channel 2 data is used. Be aware, however, that channel 2 must have been selected long enough for a complete sweep to have occurred after selecting **DATA from CHANNEL 2** to have meaningful results.

Domain

The features in the Domain menu (Figure 4-11) are listed and described below:

- | | |
|--------------------------|--|
| Frequency Domain | Frequency Domain is the factory preset state. The device under test response is displayed in relative frequency. Measurements may be made over a ramp, step, or frequency list range, or as a single point frequency. |
| Time Domain | Time Domain is available with an 8510C Option 010 system. Selecting either TIME LOW PASS or TIME BAND PASS selects the time domain mode.

In time domain mode, the system makes a frequency domain measurement, then mathematically converts and displays the device under test response in time or distance. Time domain does not function in the frequency list sweep mode. Time domain operations are more thoroughly explained in the “Time Domain Measurements” chapter of this manual. |
| Auxiliary Voltage Domain | Auxiliary Voltage Domain (AUX. VOLT OUTPUT) selects the mode where frequency sweep is fixed at the current start, or single point, frequency, then the voltage at the instrument’s rear panel AUX OUTPUT is swept from the specified start voltage to the specified stop voltage. The result is a measurement of the device response with respect to the voltage output value. Refer to the procedure that follows for an example of this function. |
| Power Domain | POWER Domain displays the measurement trace in power units. Pressing POWER in the Domain menu selects this mode.

In power domain, the frequency sweep is fixed at the current start or a selected single point frequency, then the power output from the source is swept from the specified start power to the specified stop power. The result is a measurement of the device response with respect to the power value. Power domain operations are explained more thoroughly in the “Power Domain Measurements” chapter of this manual. |

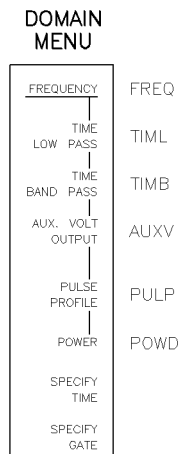

domainmain

Figure 4-11. Domain Main Menu Structure

DOMAIN Functions

Automatic Memory of Domain Settings

A domain selection is always uncoupled. Using any domain may be selected independently for either channel. The control settings used in the selected domain are a part of the Channel/Domain/Parameter/Format/Response-limited instrument state, explained in Chapter 1, “The Analyzer Remembers Previous Settings (Limited Instrument State)” section. As a result, when selecting a channel, the network analyzer remembers the domain you last used, and the parameter, format, and response settings last used for that domain.

Applicable Calibration Types for Each Domain Mode

All measurement calibration types operate with any domain selection. However, a calibration performed in the AUX. VOLT DOMAIN applies only to that domain. Although a calibration performed in Time Domain is valid for the Frequency Domain, and vice-versa, it is faster to calibrate in Frequency Domain.

Auxiliary Voltage Domain Example

A typical application for the auxiliary voltage domain feature might be for a device whose response is controlled by a voltage. Such a device might be a voltage-controlled attenuator, or a bias voltage on an active device. To become familiar with using the Auxiliary Voltage Domain function, try the procedure below:

1. Press **RECALL**, **MORE**, and **FACTORY PRESET**.
2. In the Stimulus block, press **MENU**, **SINGLE POINT**, **CENTER**. Select a frequency value for the measurement.
3. Press **DOMAIN**, then press **AUX. VOLT OUTPUT**. Notice that the stimulus axis for the log mag display is labeled **START -1V** and **STOP 1.0V**. This means that while the frequency output of the source is set to a single frequency, the voltage at the rear panel **AUX OUTPUT** is being swept from -1 volt to 1 volt at a rate selected by the current sweep-time setting.
4. Press **START** and change the start voltage. Press **STOP** and change the stop voltage. *The maximum range is -10 volts to +9.995 volts.*
5. Measure the voltage at the rear panel **AUX OUTPUT** connector with an oscilloscope.

You will discover that the voltage sweep is not a true analog sweep, but changes in discrete steps, as determined by the start- and stop-values and the number of points.

6. As you observe the voltage sweep, change the number of points, the start- and stop-values, and the sweep time. Observe the changes to the voltage output waveform.
7. Change the measurement frequency, as explained below:
 - Press **DOMAIN**, then **FREQUENCY**.
 - Press **CENTER**, and enter the new center-frequency.
 - Press **DOMAIN**, then **AUX. VOLTAGE OUTPUT**.

FORMAT

Format block keys and the associated Format menu, shown in Figure 4-12, allow choices of the format used in displaying the measurement. Any format may be chosen for any parameter.

Cartesian Formats

Seven Cartesian display formats are available:

- Log Magnitude
- Phase
- Delay
- SWR
- Linear Magnitude
- Real
- Imaginary

Smith Chart Formats

Two Smith chart display formats are available:

- Smith chart
- Inverted (admittance) Smith chart

Polar Display Formats

Three polar displays are available, differing in the nature of the trace marker used:

- Linear magnitude and angle
- Logarithmic magnitude and angle
- Real/imaginary

Examples of the available display formats are shown in Figure 4-13 and Figure 4-14.

Format Keys Available on the Front Panel

Four of these display formats are available simply by pressing the labeled front-panel keys: **LOG MAG**, **PHASE**, **DELAY**, and **SMITH CHART**. Press the **FORMAT MENU** key to display the Format menu. Choices on this menu allow choice of any of the other display formats. Press the corresponding softkey. The display immediately changes to the format selected.

Explanations of how to use the various display formats in measurement applications appear later in this manual, under the headings “Reflection Measurements” and “Transmission Measurements.”

FORMAT Functions

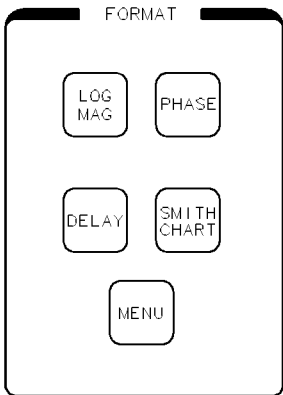

FORMAT MENU

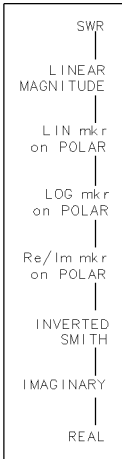

format 1

Figure 4-12. Format Function Block and Format Menu

CARTESIAN DISPLAYS

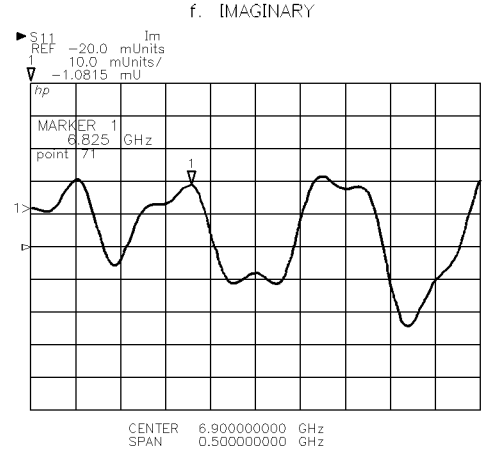
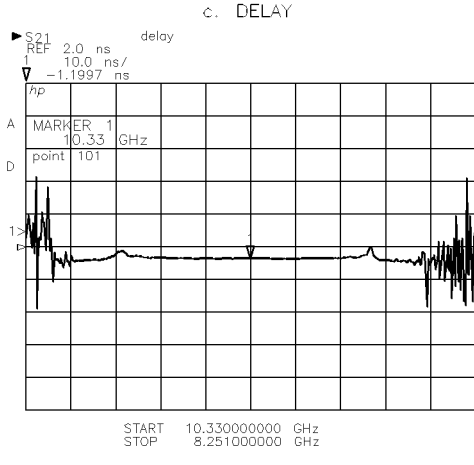
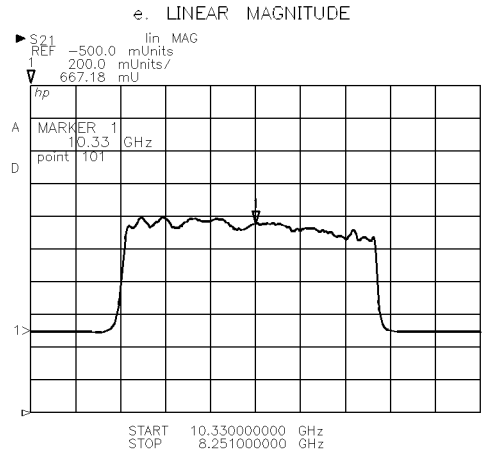
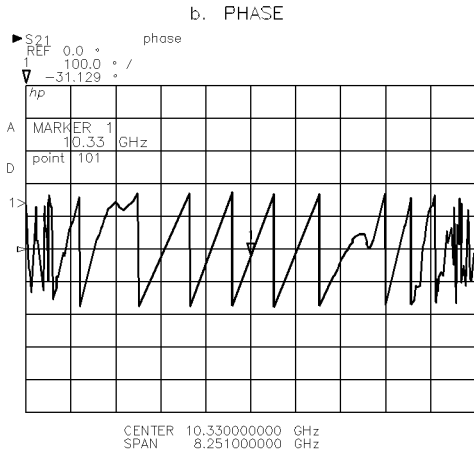
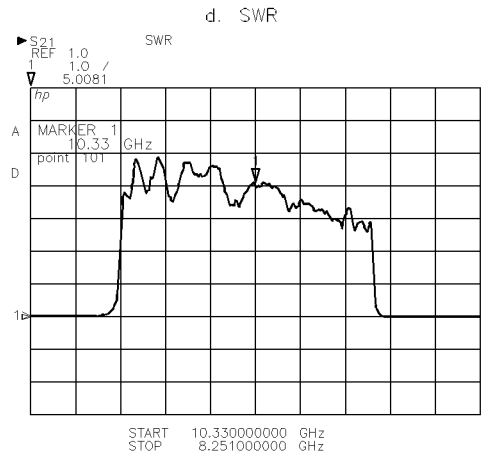
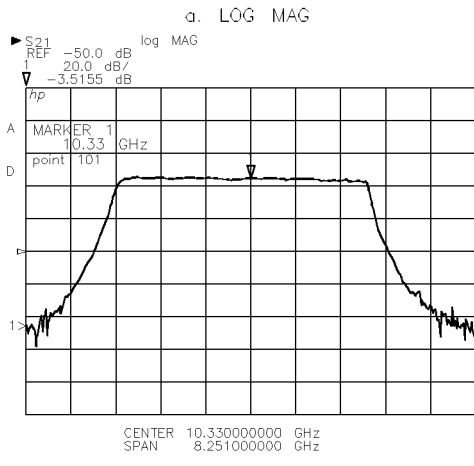
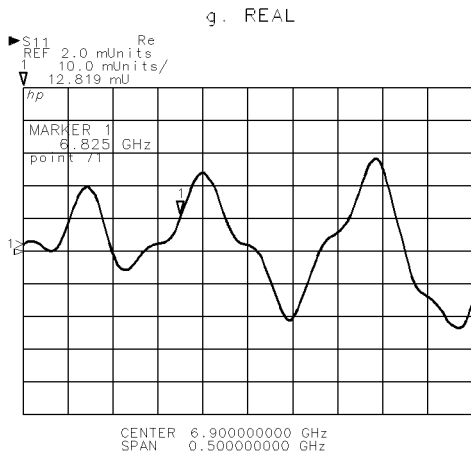

Figure 4-13. Format Selections (1 of 2)

FORMAT Functions

CARTESIAN DISPLAY



POLAR DISPLAYS

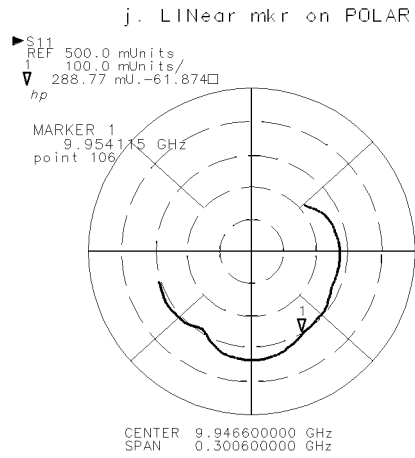

SMITH CHART DISPLAYS

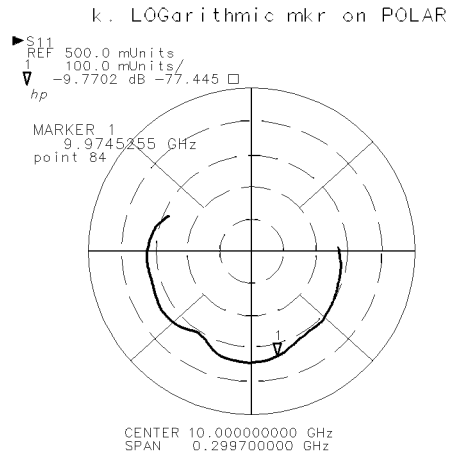
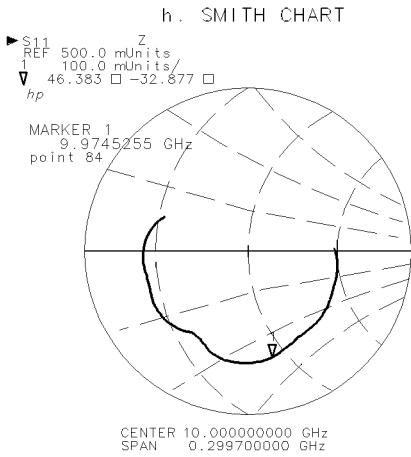

i. INVERTED SMITH CHART

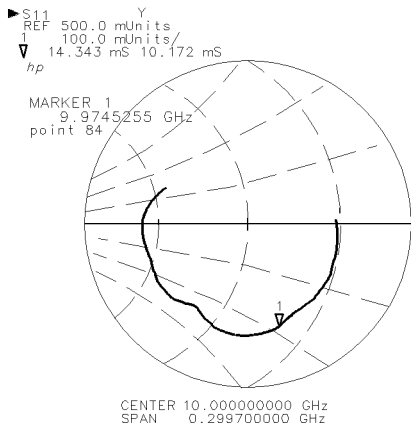

l. Real/Imaginary mkr on POLAR

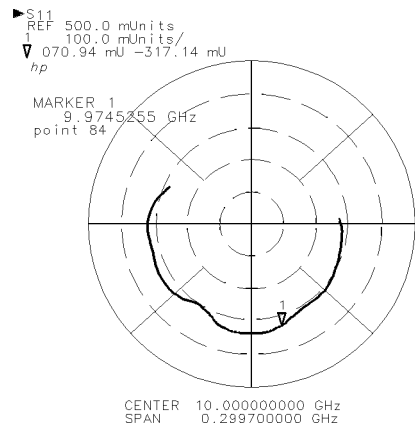

Figure 4-14. Format Selections (2 of 2)

Markers

Marker functions are:

- Simple markers on the display trace
- Δ marker mode
- Marker search modes
- Marker list modes

In addition, you can choose whether markers can move only to measured values or continuously along the trace.

Using the Markers

Markers are most often used to read the trace value at the marker position. The trace value is displayed in the Channel Identification block directly below scale/1. The stimulus value (frequency, time, or voltage depending upon the domain selected) at the marker position is displayed in the Active Function area of the LCD/CRT.

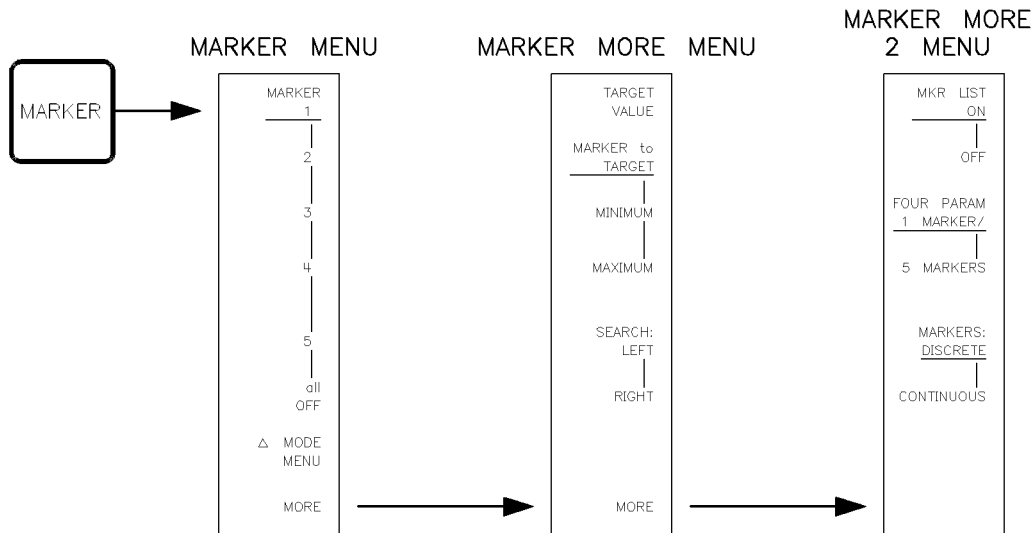

Figure 4-15. MARKER Key and Marker Menus

Select the Active Marker

Markers are made active by pressing the **MARKER** key in the MENUS block and choosing a marker from the Marker menu:

1. Press **MARKER**.

This causes the last selected marker, Marker 1 after Factory Preset, to be displayed on the trace and display the Marker menu. You can now move the selected marker to any position on the trace using the knob, step, or numeric entry keys.

2. Press **MARKER 1**, **2**, **3**, **4**, or **5** softkeys to select another of the five measurement markers as the active marker.
3. Use the knob, step, or numeric keys to position the marker.

Table 4-3. Marker Units

FORMAT	MARKER Basic Units
LOG MAG	dB
PHASE	degrees (°)
DELAY	seconds (s)
SMITH CHART	$R \pm jX$ (Ω)
SWR	(unitless)
LINEAR MAGNITUDE	ρ (unitless) (reflection)
	τ (unitless) (transmission)
LIN mkr on POLAR	$\rho \angle \varphi$ (reflection)
	$\tau \angle \theta$ (transmission)
LOG mkr on POLAR	dB $\angle \varphi$
Re/Im mkr on POLAR	$x \pm jy$ (unitless)
INVERTED SMITH	$G \pm jB$ (Siemens)
REAL	x (unitless)
IMAGINARY	jy (unitless)

For unitless quantities such as Linear Magnitude and Real, the marker value is displayed in units (u=units; mu=milliunits). A reflection coefficient measurement of 0.94 is displayed as 940.00 milliunits.

Continuous and Discrete

Press **MARKER**, then **MORE MORE** to display the third Marker menu. The two choices **MARKERS DISCRETE** and **MARKERS CONTINUOUS** select how the marker moves along the trace. Factory Preset selects **MARKERS DISCRETE** because the measurement is made at discrete frequencies with frequency resolution that depends upon the frequency span and the number of points. When you select **MARKERS CONTINUOUS**, the marker can be moved continuously across the trace with trace values between the actual measured points obtained by the process of linear interpolation.

In Continuous mode, the marker value is obtained by a simple, linear interpolation between adjacent measured points. The accuracy of the marker readout is not specified and the resulting data value must be used with some caution.

Marker List Displays

The third Marker menu also contains the marker list functions:

- **MARKER LIST ON / OFF**
- **FOUR PARAM 1 MARKER/**
- **FOUR PARAM 5 MARKERS**

A marker list can contain the frequency and unit information for all displayed markers for one parameter, or the list can contain the frequency and unit information for one marker for all four parameters.

For example, to illustrate the marker list feature and the operation of discrete markers, set the analyzer to continuously sweep from 2 to 18 GHz (201 points), S_{11} , LOG MAG.

MARKER Functions

1. Press **MARKER**.
2. Select **MARKER 1** **2** **GHz**.
3. **MARKER 2** **4** **GHz**.
4. **MARKER 3** **6** **GHz**.
5. **MARKER 4** **8** **GHz**.
6. **MARKER 5** **1** **3** **.** **5** **GHz**.
7. **MORE MORE**
8. **FOUR PARAM 5 MARKERS**.
9. **MKR LIST ON**

A marker list similar to the one shown below appears in the marker-display area:

MARKER 1
2.02 GHz
-26.461 dB

MARKER 2
3.975 GHz
-20.99 dB

MARKER 3
6.015 GHz
-22.54 dB

MARKER 4
7.97 GH
-21.56 dB

▶MARKER 5
13.495 GHz
42.6 dB

Notice the ▶ symbol next to the marker 5 annotation. This symbol denotes the active marker. If marker list is on (Factory Preset), whenever the softkey menu display area is empty and markers are active, the marker list is displayed. Press **PRIOR MENU** as many times as necessary to display the marker list. It is not required to activate all five markers to display a five marker list.

Note also the frequency values for each of the markers. Even though you entered 2, 4, 6, 8, and 13.5 GHz as the values for the marker frequencies, because discrete markers are selected, the value entered and the value displayed are not exactly the same.

The **FOUR PARAM 1 MARKER/** selection lists the active marker value for each parameter when the display mode is four parameter. The list below is an example.

```

MARKER 3
6.015 GHz

S11
-22.54 dB

S21
1.49 dB

S12
1.54 dB

S22
-24.25 dB
    
```

Marker 3 is the active marker in this case. Note that the color of the marker list matches the data shown for that parameter. Four parameter displays can choose either type of marker list. Single parameter displays or dual channel displays can choose five marker lists only.

Delta Mode Markers

Use the Δ marker mode to read the difference in trace value and stimulus value between any currently selected active marker and another marker designated as the reference marker.

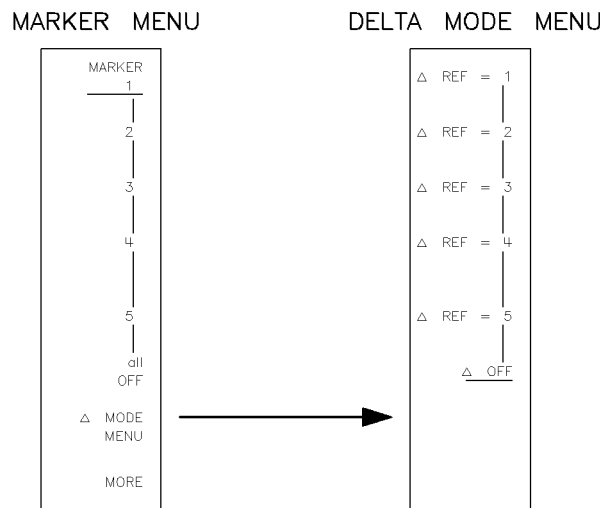

Figure 4-17. Marker and Mode Menus

The Δ Mode sequence uses both the Marker menu and the Δ Mode menu as follows:

1. Press **(MARKER)**. A marker is displayed and the Marker menu appears. Use the knob to position this marker to any desired point on the trace.
2. Press the **Δ MODE MENU** softkey. This displays the Δ Mode menu.

MARKER Functions

3. Choose the reference marker by pressing a softkey (Δ REF = 1, 2, 3, 4, or 5) different from the current active marker. Any marker can be designated as the reference marker, causing the currently selected active marker to read relative to it. The Marker menu reappears on the display with the marker Δ REF = label.
4. Use the knob to position the active marker anywhere on the trace. The stimulus difference between the active marker and the reference marker is displayed as the active entry. The trace value difference between the active marker and the reference marker is displayed in the normal marker readout.

If the current active marker and the reference marker are at the same position, the displayed value is zero.

If the current active marker is also selected as the reference marker, the displayed value is zero at all points on the trace because the marker is reading relative to itself.

To exit the Δ marker mode, press Δ MODE MENU Δ OFF.

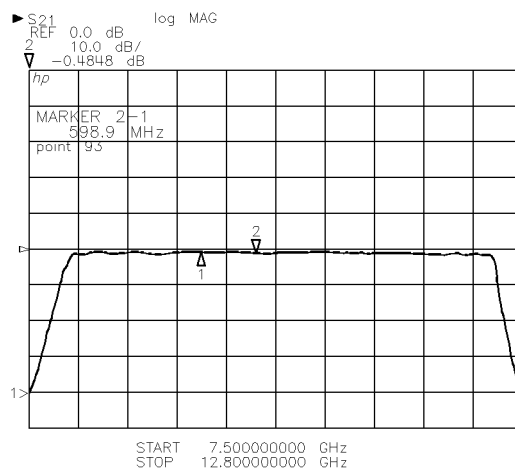

Figure 4-18. Mode Markers on Trace

Marker Search Modes

Select any of three marker search modes by pressing **MARKER**, **MORE**, then **MARKER to MINIMUM**, **MARKER to MAXIMUM**, or **MARKER to TARGET**. When you press one of these softkeys, the mode selection is underlined and the selected search is executed.

MARKER to MINIMUM and **MARKER to MAXIMUM** always find the minimum or maximum data point on the trace, respectively.

MARKER to TARGET begins at the lowest stimulus value (the left side on Cartesian displays), and searches for the target value.

- If in discrete marker movement mode, the search stops at the stimulus point nearest to the target value. The search always stops at the nearest actual measurement point that is below the target value.
- If in continuous marker movement mode, the search stops at the trace value. The active function shows the stimulus value and the actual trace value is shown in the marker readout.

Unsuccessful target searches result in the message **TARGET VALUE NOT FOUND**.

Set the target value by pressing **TARGET VALUE**, then enter the target value for the current Format using the knob, step, or numeric keys. Switch between formats to see that the target value is different for each format selection. Factory Preset selects a certain target value for each format, for example **-3 dB** for **LOG MAG**.

As an example:

1. Move the marker to any position on the trace, then press **TARGET VALUE**, **=MARKER**.
2. Now move the marker to another position on the trace, then press **MARKER to TARGET**. The marker moves to the trace value closest to the target value,

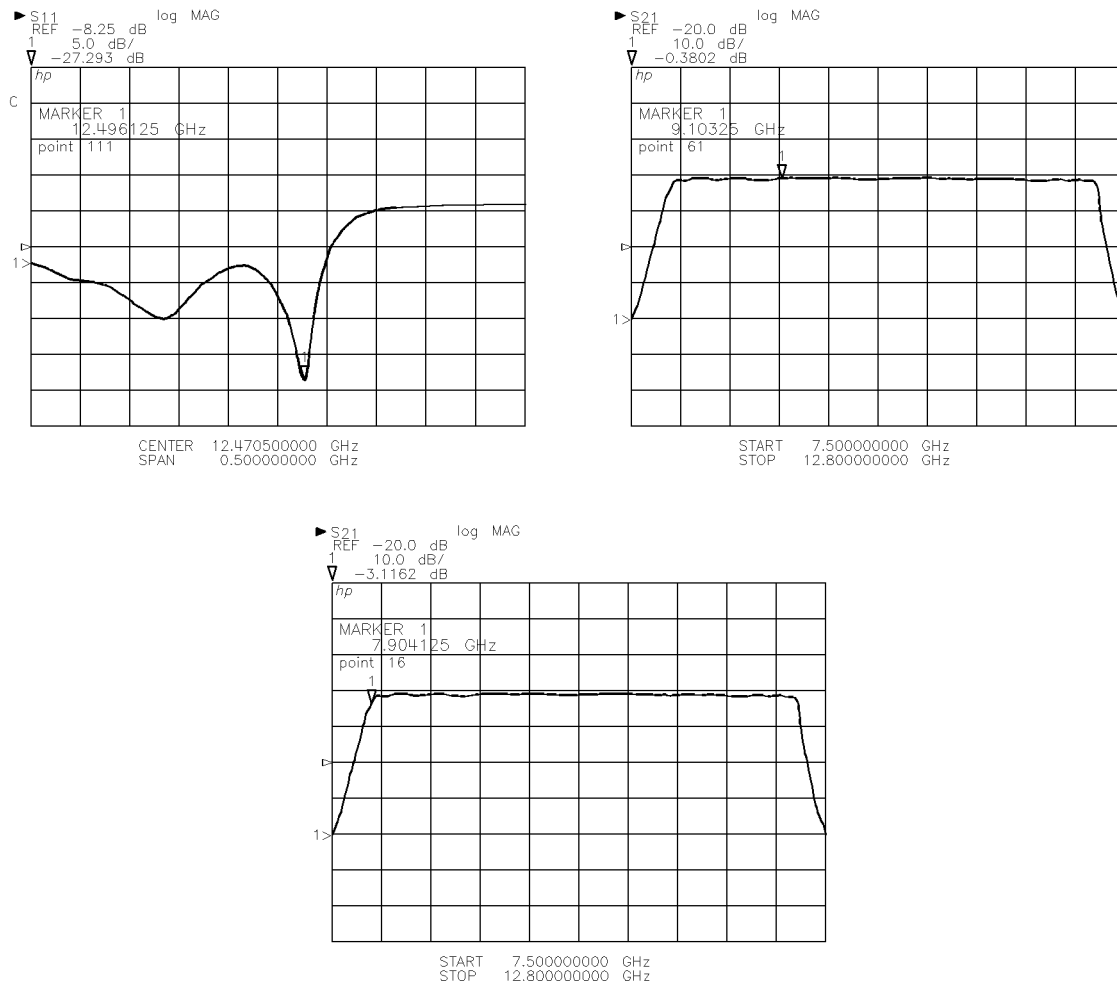

Figure 4-19. Marker Search Modes

Search Right and Search Left

Press **SEARCH RIGHT** or **SEARCH LEFT** to search for the next minimum, maximum, or target value beginning from the present marker position to the right or left on the trace, respectively.

MARKER Functions

Delta Mode Operation

When operating in the delta mode, the target searches begin from the current reference marker instead of the lowest stimulus value. For example, a target search for -3 dB moves the active marker to the next point -3 dB relative to the reference marker, to the right or left of the reference marker, if a point exists.

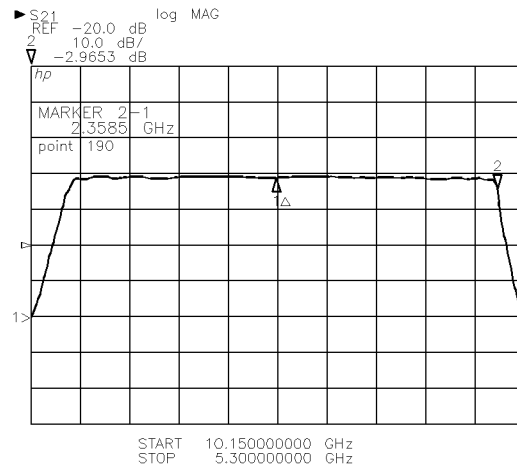

Figure 4-20. Mode Marker to Target

Marker Familiarization Sequence

1. Press **RECALL MORE FACTORY PRESET**, then select a display with several maximums and minimums.
2. Press **MARKER**. Marker 1 is active. The stimulus value and the trace value are displayed, and the Marker menu appears.
3. Position the marker on the trace using the knob, the step keys, or numeric entry.
4. Press **MARKER 2**. Marker 2 is now active. Note the triangle symbol at marker 1 inverts to indicate that it is no longer the active marker. Position marker 2.
5. Press **MARKER 1**. Marker 1 is now active; Marker 2 symbol inverts. Press **Δ MODE MENU**, then press **Δ REF = 2**. The delta symbol appears near marker 2 to indicate that it is the reference marker. The stimulus difference and trace value difference between the active marker and the reference marker (active – reference) is displayed.
6. Use the knob to move marker 1.
7. Press **MARKER 3**. Marker 3 is now the active marker and it reads relative to marker 2.
8. Press **MORE MORE MKR LIST ON**. The marker list appears in the softkey menu display area. Notice that all readings are differences between the reference marker (2) and the other markers. Marker 3 is denoted as the active marker by the ► symbol in the marker list.
9. Press **MARKER Δ REF = 2**. Marker 2 is now active and it reads relative to itself. Use the knob to position marker 2.
10. Press **Δ MODE MENU**, then **Δ OFF**. Marker 2 is active and it reads the trace value.

11. Press **all OFF**. The markers disappear.
12. Press **MARKER**, **MORE**, **MARKER to MINIMUM**. Marker 2 (which was the last active marker) moves to the minimum trace value.
13. Press **SEARCH LEFT**. Marker 2 moves to the next trace minimum between the present marker position and the beginning of the trace.
14. Press **PRIOR MENU**, **MARKER 1**, **MORE**, **MARKER to MAXIMUM**. Marker 1 moves to the maximum trace value.
15. Press **MARKER to TARGET**. Marker 1 begins from the lowest stimulus value and moves to the measurement point that is closest (but less than) the target value. If the message **TARGET VALUE NOT FOUND** appears, press **TARGET VALUE** and enter an appropriate value for the current format, then press **MARKER to TARGET** again.
16. Press **SEARCH RIGHT**. Marker 1 moves to the first target value to the right (increasing stimulus) of its present position, if another target value is found.
17. Press **SEARCH LEFT**. Marker 1 moves to the first target value to the left (decreasing stimulus) of its present position, if found.
18. Press **PRIOR MENU**, **Δ MODE MENU**, then **Δ REF = 2**. Now marker 1 is active and marker 2 is the reference.
19. Press **MORE**, **MARKER to TARGET**. Marker 1 begins from the current reference marker position and moves to the first point closest to the target value, if found.
20. Press **SEARCH RIGHT**. Marker 1 moves to the first target value to the right (increasing stimulus) of the reference marker position, if found. Press **SEARCH LEFT**. Marker 1 moves to the first target value to the left (decreasing stimulus) of the reference marker, if found.
21. Press **PRIOR MENU** **Δ MODE MENU** **Δ OFF** **all OFF**.

Parameter

PARAMETER block keys are used to select the parameter to be measured and displayed. The Parameter menus make it possible to measure the approximate signal levels in the test set, and allow you to and to change parameter definitions in order to use the network analyzer system in special measurement applications.

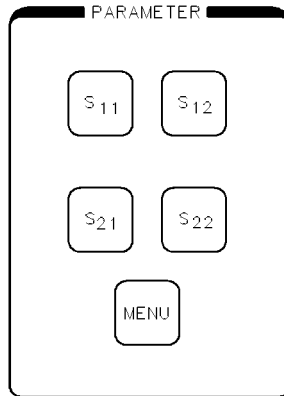

Figure 4-21. Parameter Function Block

Basic Parameters

The **S₁₁**, **S₂₁**, **S₁₂** and **S₂₂** keys are used to select the parameter to be measured and displayed. Notice the label that shows the parameter being displayed in the channel Identification area of the LCD/CRT. These selections correspond to the signal flow diagram on the front panel of the test set. They are called the “basic” parameters. When an S-Parameter test set is used, test set switching is done automatically to choose the correct reference and test signal paths for the selected parameter.

S-Parameter Definitions and Conventions

S-parameters are used predominantly at microwave frequencies because they provide a simple notation with exact data on device performance in achievable environments. The fact that the device under test is embedded in a characteristic impedance (usually, $Z_0 = 50 \Omega$) is fundamental to definitions of S-parameter measurements. S-parameters are easy to measure, and there are analytically convenient methods for predicting the response of the device when combined with other devices for which the S-parameters are known.

The test set front panels use S-parameter flowgraph notation in order to identify the measurement capabilities of the test set. Let us examine S-parameter definitions and conventions in order to understand these symbols.

First, S-parameters are always a ratio of two complex quantities. Complex means that both a magnitude and a phase angle must be used to specify the quantity. S-parameter notation identifies these quantities using numbers. The S-parameter numbering convention is:

$$S_{\text{out in}}$$

where the first number (out) refers to the port where energy is emerging and the second number (in) names the port at which energy is incident. Thus, the S-parameter S_{21} identifies

the measurement as the complex ratio of the energy emerging at port 2 with respect to the energy incident at port 1.

Look at the flow diagram in the left-side of Figure 4-22. This is a flowgraph representation of a two-port device. Each port has two nodes: one representing the entering or “a” wave and one for the emerging “b” wave. Lines that connect nodes are called branches. Each branch has an arrow and value corresponding to an S-parameter. Energy flows only in the direction of an arrow.

This two-port flowgraph is used on the front panel of the S-parameter test set to indicate that the test set can measure any of the four S-parameters by internally switching the incident power to either Port 1 or Port 2 of the device under test. The indicator near a_1 lights to indicate that power is emerging from Port 1 of the test set (S_{11} or S_{21} selected); the indicator near a_2 lights when power is emerging from Port 2 of the test set (S_{22} or S_{12} selected).

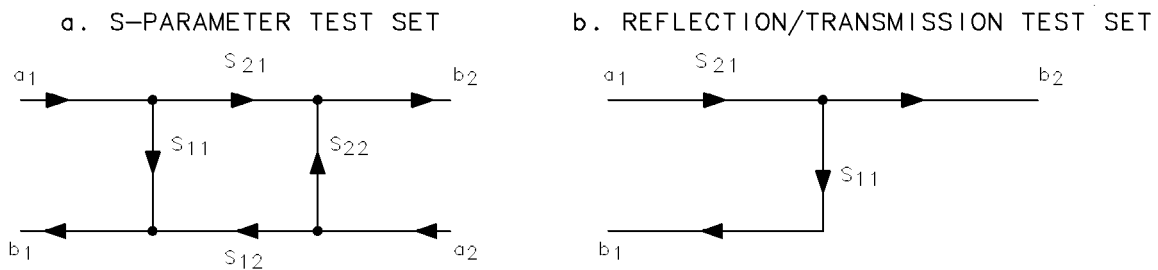

Figure 4-22. S-Parameter Flowgraphs

Now look at the flowgraph on the right-hand side of Figure 4-22. This flowgraph appears on the front panel of reflection/transmission test sets. It shows that energy can only be applied at the a_1 node. To measure the reverse parameters the two-port device must be physically turned around. Note that the user is responsible for choosing the correct parameter to display when using this test set, either the forward parameters, S_{11} and S_{21} , or the reverse parameters, S_{22} and S_{12} .

Parameter Menu

Pressing the PARAMETER **MENU** key summons the top level Parameter menu. This menu and the associated redefine parameter menu can be used to:

- Measure approximate signal levels in the test set.
- Change the definitions of the four basic S-parameters.
- Redefine the four user parameters.

PARAMETER Functions

PARAMETER MENU

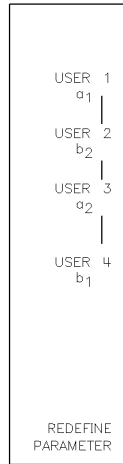

Figure 4-23. Parameter Menu

User Parameters

After Factory Preset, the measurement selections **USER 1 a₁**, **USER 2 b₂**, **USER 3 a₂**, and **USER 4 b₁**, are defined to allow measurement of the unratiod power at the first frequency converter inputs for each of the reference and test signal paths.

For example, press **PARAMETER (MENU)**, then **USER 1 a₁**. Figure 4-24 shows a typical display of this measurement. Refer to the test set signal flow diagrams, Figure 3-4 and Figure 3-5 in Chapter 3 of this manual. This display represents the power incident at the a₁ first frequency converter, which is the reference signal for forward measurements. Now select **USER 2 b₂**, which is the transmitted signal for forward transmission measurements. The ratio of these two measurements is displayed when you select S₂₁.

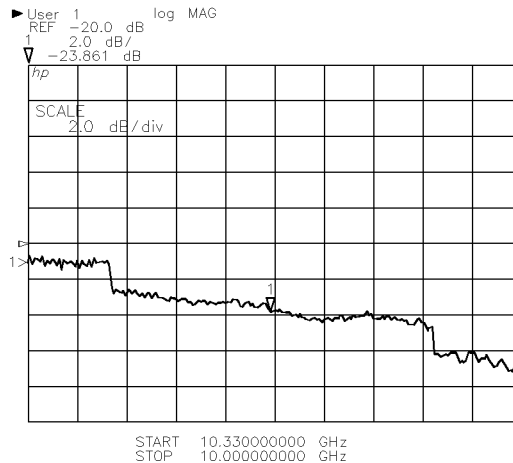

Figure 4-24. Typical User 1, a₁ Measurement

Please be aware that this measurement is not displayed with power meter accuracy, and the frequency response and conversion loss of the frequency converter is not included. However, these User parameters, when properly applied, are of great value in setting up the network analyzer to achieve maximum accuracy and dynamic range. Later in “Dynamic Range Considerations,” you can use these User parameters to measure and set the signal levels in the test set.

Redefine Parameter

Redefining parameters makes it possible to use custom test sets built around the 8511 frequency converter and to use the network analyzer system in special measurement applications.

In frequency response calibrations both basic and user parameter definitions can be used. Because the 1-Port and 2-Port calibration models include automatic parameter selection, only the four basic S-parameters can be used in these calibrations (Figure 4-25).

FACTORY PRESET restores all basic and user parameter definitions to their standard values.

Table 4-4 lists the standard parameter definitions selected when the **FACTORY PRESET** key is pressed and an S-parameter test set responds to that preset.

Table 4-4. Standard PARAMETER Definitions

Function	Parameters							
	Basic				User			
	S ₁₁	S ₂₁	S ₁₂	S ₂₂	a ₁	b ₂	a ₂	b ₁
Drive port	1	1	2	2	1	1	1	1
Phase lock	a ₁	a ₁	a ₂	a ₂	a ₁	a ₁	a ₁	a ₁
Numerator	b ₁	b ₂	b ₁	b ₂	a ₁	b ₂	a ₂	b ₁
Denominator	a ₁	a ₁	a ₂	a ₂	NO RATIO			
Conversion	S	S	S	S	S	S	S	S

Note: For Reflection/Transmission Test Sets, or no test set, the standard definitions are: S₂₂ = S₁₁ and S₁₂ = S₂₁.

Ports and nodes are identified on the front panel of the test set. In all cases the notation used is the same as on the test set block diagrams (Figure 4-4 and 4-5).

PARAMETER Functions

Redefine Basic Parameters

To redefine one of the basic S-parameters (S_{11} , S_{21} , S_{12} , S_{22}):

1. Press PARAMETER **MENU**.
2. Press the front-panel key in the PARAMETER block that corresponds to the parameter to be redefined: **S11**, **S21**, **S12**, or **S22**.
3. Press **REDEFINE PARAMETER**. This displays the Redefine Parameter menu.
4. Use the softkeys to choose the drive port, phase lock, numerator, denominator, and conversion definitions to be used in the new definition of the parameter:

Press the softkey corresponding to the item on the Redefine Parameter menu to be redefined. This displays a menu of the available choices, and the current selection is underlined. Press the softkey corresponding to the new definition.

Changes are executed immediately when the softkey corresponding to the new definition is pressed.

5. When the parameter has been redefined, press **REDEFINE DONE** to save the instrument state that has now been defined. Now each time you select this parameter, your definition is displayed.

Please note that Factory Preset restores the standard S-parameter definitions given in Table 4-4. Redefined basic S-parameters cannot be recalled as part of an instrument state.

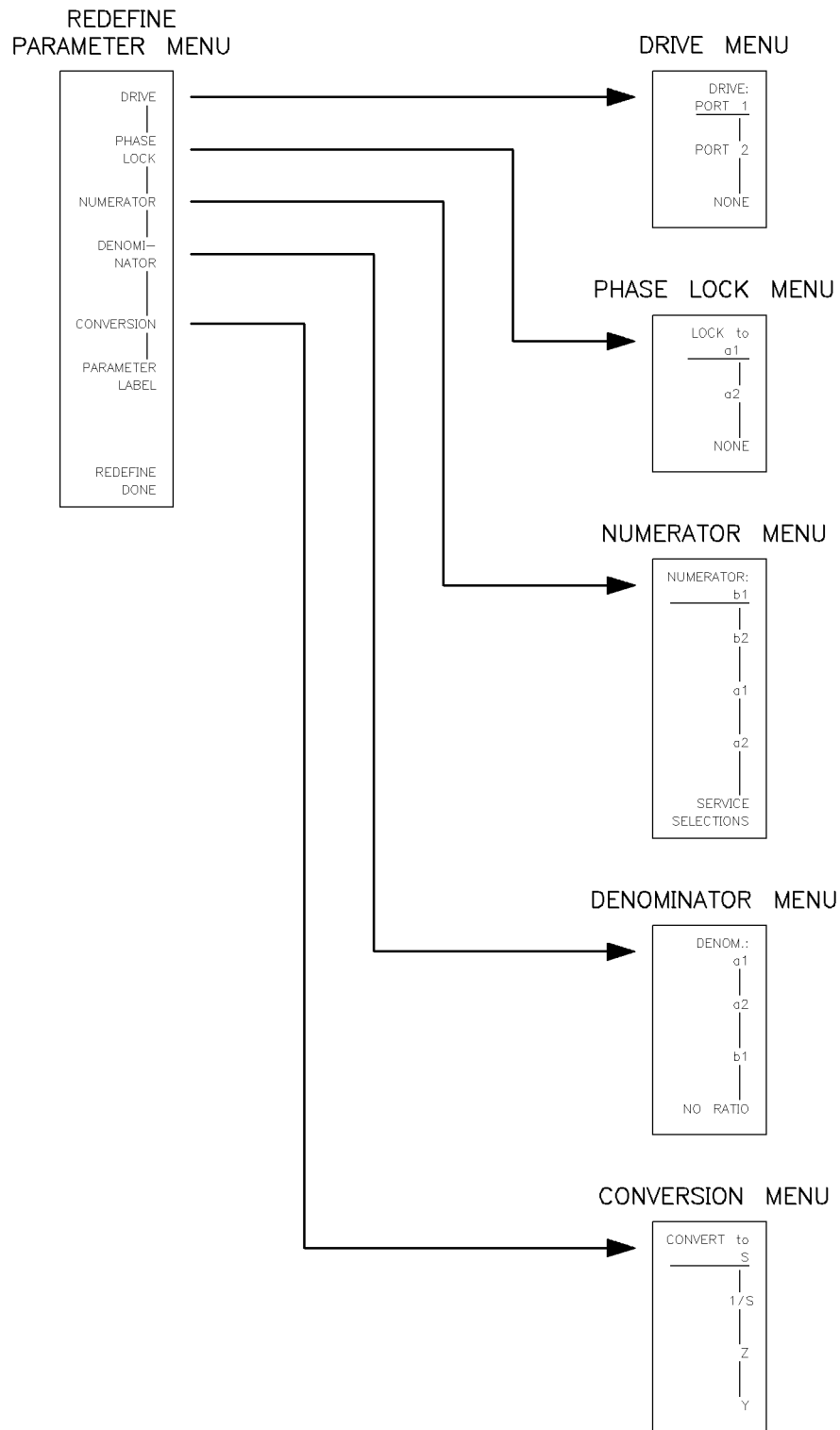

Figure 4-25. Redefine Parameter Menu Structure

PARAMETER Functions

Redefine User Parameters

To define a User parameter:

1. Press PARAMETER (MENU). This displays the Parameter menu.
2. Press the softkey that corresponds to the user parameter you wish to redefine: USER 1, USER 2, USER 3 or USER 4. Your choice will now be underlined.
3. Press REDEFINE PARAMETER. This displays the Redefine Parameter menu.
4. Use the corresponding softkeys to define the drive port, phase lock, numerator, denominator, and conversion definitions for the user parameter.

Changes are executed immediately when the softkey corresponding to the new definition is pressed. The Redefine Parameter menu also reappears on the LCD/CRT, allowing further changes or definitions if desired.

5. To redefine the label of the parameter, press the softkey PARAMETER LABEL. This displays the Title menu and the existing label.

To delete the whole title, press the softkey ERASE TITLE or use the (BACKSPACE) key in the ENTRY block. To enter a character, position the ↑ symbol below the character by turning the knob, then press SELECT LETTER. The character appears in the title area. Repeat this process to write the rest of the new label.

When you have finished entering the new label, press the softkey labeled TITLE DONE. This enters the new label and returns the Redefine Parameter menu to the display. The label appears in the channel identification area of the display when the parameter is selected.

6. When you have finished defining and labeling the parameter, press REDEFINE DONE to save the instrument state that has now been defined.

Any of the four user-defined parameters can be defined in this way. They can be saved and/or recalled as part of an instrument state and used in frequency response calibrations.

(USER PRESET) (or recalling an instrument state) restores the standard basic parameter definitions given in Table 4-4.

Measuring Power (dBm)

Signal levels (in dBm) at the first frequency converter in the test set can be measured by using the standard USER 1 through USER 4 definitions on the Parameter menu. In this way it is possible to determine the approximate dynamic range available for measurements in the actual setup being used. The measurement is approximate because no account is taken of variations in losses in the signal path before detection. To compensate for flatness variations, use the calibrate flatness functions discussed under the STIMULUS controls section.

Signal flow in the various test sets used with the network analyzer system is shown in Figure 4-4, Figure 4-5, and Figure 4-6. Table 4-5 lists the measurements that are displayed using the standard user parameter definitions given in Table 4-4. Use the following procedure to measure power:

1. Press **RECALL MORE FACTORY PRESET**, then press **PARAMETER MENU**. This displays the Parameter menu.
2. Refer to Table 4-5 and press the softkey corresponding to the power level you wish to measure: **USER 1 a₁**, **USER 2 b₂**, **USER 3 a₂**, or **USER 4 b₁**.

Note that since a₂ is defined as phase locking from and driving Port 1, with S-parameter test sets it must be redefined before it can be used directly as an indication of the Port 2 drive power.

3. Press the **MARKER** key in the MENUS block.

The trace now displays the power level in dBm. Use the knob to position the marker on the trace to read the power at the first frequency converter.

Table 4-5. Measuring Power (dBm) at First Frequency Converter

Function	Reflection/Transmission and S-Parameter Test Sets
a ₁	Reference (S ₁₁ and S ₂₁)
b ₂	Transmitted to Port 2. (Connect Thru) or (S-parameter test sets only) Reflected at Port 2. (Connect Short Circuit)
a ₂	Reference (S ₁₂ and S ₂₂) for S-parameter test set. (Not used for reflection/transmission test set.)
b ₁	Reflected at Port 1. (Connect Short Circuit) or (S-parameter test sets only) Transmitted to Port 2. (Connect Thru)

To approximate the power incident at the device under test, for example, connect a short circuit at port 1, and select **b₁** for display. The trace represents the power appearing at the b₁ frequency converter. Since there is loss in the reflection signal path between port 1 and the frequency converter, and because of conversion loss of the frequency converter, the actual power at the port is greater. Table 4-6 and Table 4-7 list approximate losses in the test sets.

To approximate the power appearing at port 2, connect the thru and select **b₂** for display. The difference between the power reading with the thru connected and disconnected is the approximate dynamic range available for the transmission measurement.

Table 4-6. Approximate Insertion Losses in Test Sets (dB)

Test Set	Source to a ₁ or a ₂ ¹	Source to port	Port 1 to b ₁ (S ₁₁)	Port 1 to b ₂ or Port 2 to b ₂ (S ₂₁ , S ₂₂ or S ₁₂)
8512A	-28 dB	-8 dB	-20 dB	0 dB
8513A	-26 dB	-15 dB	-13 dB	-3 dB

¹ -0.35 dB/GHz

PARAMETER Functions

Table 4-7. Approximate Insertion Losses in Test Sets (dB)

Test Set	Source to a ₁ or a ₂ ¹	Source to port	Port 1 to b ₁ or Port 2 to b ₂ (S ₁₁ or S ₂₂)	Port 1 to b ₂ or Port 2 to b ₂ (S ₂₁ or S ₁₂)
8514A/B	-28 dB	-8 dB	-20 dB	-20 dB or
				-7 to -20 w/ Opt 003
8515A	-26 dB	-15 dB	-13 dB	-13 dB
8517B	-15 to -28 dB	-8 dB	-15 to -12 dB	-15 to -12 dB

1 -0.35 dB/GHz

In systems with an S-parameter test set, this method can also be used to see the effects of changing the internal attenuator values. Change the attenuator value using the method described earlier under the heading of “Attenuator Port: 1 and Attenuator Port: 2” under Stimulus.

That is, press STIMULUS (MENU), POWER MENU, ATTENUATOR PORT: 1 or 2, and then use the step keys to change the internal attenuator value. Then measure power using the method described here.

Dynamic Range Considerations

As stated earlier, after Factory Preset, the source power level is appropriate for most measurements on passive devices and for range without overload or excessive measurement uncertainty. The maximum signal that can be applied to port 1 or port 2 of the test set without damage is about +20 dBm. For measurements on passive devices, the incident signal level should be as high as the test device characteristics permit without exceeding -10 dBm into any of the first frequency conversion stages. For gain measurements, set the incident signal level to a value at which the expected test device output does not exceed -10 dBm into any of the first frequency converters.

Figure 4-26 shows these dynamic range considerations. Example 1 shows levels at calibration for a passive device with both reference (R) and test (T) inputs near -10 dBm. When calibrated at these levels, the maximum dynamic range is available for insertion loss measurements.

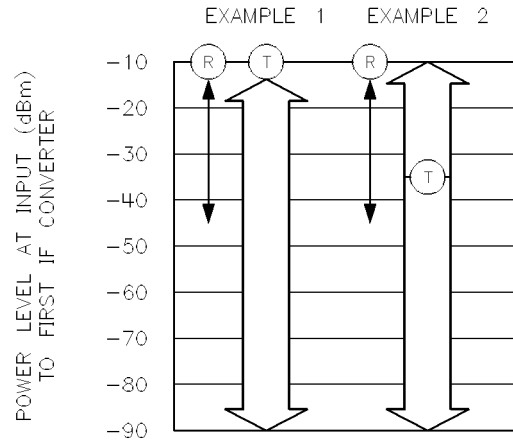

Figure 4-26. Dynamic Range Considerations

Example 2 shows levels at calibration for an active device with an expected 20 dB of gain. The reference input is set near the top of its range and the test signal is set to produce near -30 dBm with the thru connected. With an S-parameter test set, reducing the test signal level is accomplished by setting the internal port 1 attenuator to about 20 dB. At these levels the network analyzer can measure about 20 dB of gain and insertion loss down to the noise floor.

Maximum input to the reference or test first frequency conversion stage without gain compression is -10 dBm up to 18 GHz (-15 dBm, 18 to 26.5 GHz). The reference input requires at least -45 dBm to maintain phase lock.

Response

RESPONSE block function keys provide various options in positioning the trace and the reference line on the display. The associated Response menu structure offers selections for averaging and smoothing of the trace and to add magnitude and phase compensation.

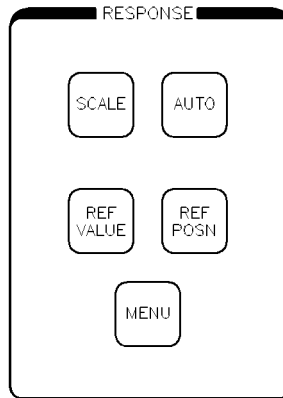

Figure 4-27. Response Function Block

Changing Display Scale and Reference

To set the scale and reference values automatically, or manually, follow the procedure for that operation.

Setting Scale and Reference Values Automatically

Press **AUTO** to automatically select a scale and reference value that results in the display of the entire trace on the LCD/CRT. You can then adjust for the preferred display. For Cartesian displays, **AUTO** usually works best when the reference line is at the center of the grid.

Changing Display Scale Manually

Press **SCALE**, and then use the knob, step, or numeric **x1** keys in the ENTRY block to change the scale/division value. The trace expands or contracts around the reference position line.

Changing the Position of the Reference Line Manually

Press **REF POSN** to move the reference position line on Cartesian displays. For Smith Chart and polar displays, **REF POSN** does not function.

The reference position line for Channel 1 is identified by the > indicator on the left of the graticule; for Channel 2 it is the < indicator on the right side of the graticule.

At Factory Preset, **REF POSN** is set to 5. To move the reference position line, press **REF POSN**, and then use the knob, step, or numeric **x1** keys to change its position. If you use the numeric keys, 0 is the bottom graticule; 10 is the top graticule.

Changing the Value of the Reference Line Manually

Use **REF VALUE** and the knob, step, or numeric and units keys to assign a new value to the Cartesian reference position line or the Smith or polar outer circle. The trace is positioned relative to the reference position so changing the reference value moves the trace, but does not change the marker value. For Smith and polar displays, changing **REF VALUE** is equivalent to changing scale/division.

Automatic Recall of Previous Display Settings

As an operating convenience, the **SCALE**, **REF VALUE**, and **REF POSN** settings are part of the Channel/Domain/Parameter/Format/Response “limited instrument state.” As mentioned in Chapter 1, the network analyzer automatically remembers previous combinations of many instrument settings. In each channel, the analyzer remembers all previous display settings for each Parameter (S_{11} , S_{21} , S_{12} , S_{22}). In addition, a completely different “memory” is automatically engaged depending on which domain or channel you are in.

Refer to the section in Chapter 1, “The Analyzer Remembers Previous Settings (Limited Instrument State)” for more detail about this concept. The “limited instrument state” or “automatic memory” remembers all past combinations of the following:

- Channel 1 or 2
- Domain (Frequency, Time or Voltage)
- Parameter (S_{11} , S_{21} , S_{12} , S_{22})
- Colors assigned to the parameters
- Display Scale, Reference, graphic presentation Format

As an example of this, select **CHANNEL 1**, **S11**, **SMITH**, **S21**, **DELAY**.

Switch between S_{11} and S_{21} . Did you notice how the network analyzer remembered the format you chose for each parameter?

CHANNEL 1 **S22** **LOG MAG** **AUTO**
CHANNEL 2 **S11** **LOG MAG**
MARKER **REF VALUE** **= MARKER**
SCALE **.1** **x1**

Now switch between Channel 1 and Channel 2 and the various parameters and formats on both channels.

Hierarchy of the Automatic Memory

Look at the list of memorized settings, above. This represents the hierarchy of the automatic memory. Each channel remembers all lower setting combinations independently. In other words, each channel acts like a completely different analyzer as far as the listed features are concerned. Domain settings, in turn, remember all setting combinations lower in the hierarchy. Each parameter setting also remembers all lower level settings (display setting).

RESPONSE Functions

The automatic memory does not include Stimulus settings. Note that the automatic memory (known as the limited instrument state) does not include a memory of stimulus values. The analyzer assumes it is more convenient to retain the same stimulus settings as you change channels and other settings.

Other options for control of Stimulus settings. You can have the two instrument channels keep track of separate stimulus settings by “uncoupling” them. Refer to “Coupled/Uncoupled Channels”.

You can save all instruments states, including Stimulus settings, using the Save/Recall feature of the network analyzer.

The Effect of Factory Preset on Display Settings

Factory Preset assigns an appropriate (SCALE), (REF VALUE), and (REF POSN) setting for each format of each parameter on each channel. Color assignments are not changed by Factory Preset.

Response Menu

Press the RESPONSE (MENU) key to display the Response menu. Choices on this menu structure allow you to add electrical delay, phase offset, magnitude slope and offset, and to apply averaging or smoothing to the trace.

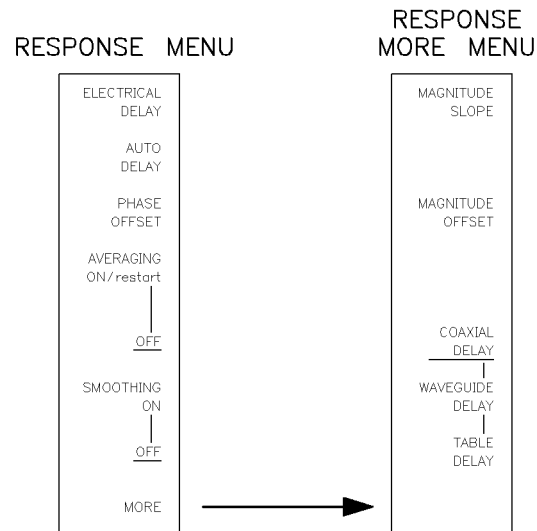

Figure 4-28. Response Menu Structure

Trace Averaging and Smoothing

Averaging reduces random noise variations in measurements, improving both accuracy and resolution. Smoothing changes the effective measurement aperture by averaging adjacent measurement points. Both averaging and smoothing can be used simultaneously. Both can be set independently for each channel.

Averaging

Averaging enhances meaningful resolution and increases dynamic range by effectively decreasing the input noise bandwidth.

Press **AVERAGE ON/restart** then use the knob, step, or numeric keys to select the averaging factor applied to the displayed data. Terminate a numeric entry with **[x1]**.

When averaging is turned on, the **A** enhancement annotation appears on the display. Averaging restarts when:

- The averaging factor is changed.
- An important measurement or display characteristic is changed.
- When a measurement calibration device is selected for measurement.
- When **AVERAGE ON/restart** or the MEASUREMENT **[RESTART]** key is pressed.

Averaging Details

In the ramp sweep mode, the new trace, weighted by $1/n$, is summed with the current trace, weighted by $(-1)/n$, where n is the averaging factor. This is an exponential running average. Also, the averaging factor selection controls the number of sweeps taken for measurement of a standard during measurement calibration. When a calibration standard selection key is pressed, $n+1$ groups are automatically taken, where n is the selected averaging factor.

Note that in the ramp sweep mode each time averaging is restarted, the averaging algorithm starts with a small averaging factor, then increases the averaging factor group-by-group, up to the selected factor, thus allowing fast convergence to the final value. This fast convergence algorithm means that the trace is fully averaged in $n+1$ sweeps rather than $4n$ sweeps, as would be the case if the fast convergence were not used. In the step sweep, single point, and frequency list sweep modes, each data point is averaged n times as it is read, so only one sweep is required to present fully averaged data. This is a linear block average.

Notification when averaging is finished. You can use the **NUMBER of GROUPS** function on the STIMULUS menu to signal when the trace is fully averaged. Here's how to do this:

1. Enter the averaging factor as explained above.
2. Assuming you chose an averaging factor of 16, enter **NUMBER of GROUPS**, **[17]**, **[x1]**. When the **H** enhancement annotation appears, the data is fully averaged.

Averaging Factor Recommendations

Select an averaging factor appropriate to the operation being performed. When adjustments to the test device or test setup are made, select a lower averaging factor (128 or below) to see changes quickly. If a very noisy trace is being analyzed, use a higher value (up to 4096) and allow more time for the trace to settle.

Averaging operates in powers of 2 only. Averaging factors which are not powers of two are rounded down to the closest power of 2. For example, if a factor of 150 is entered, it is rounded down to 128.

RESPONSE Functions

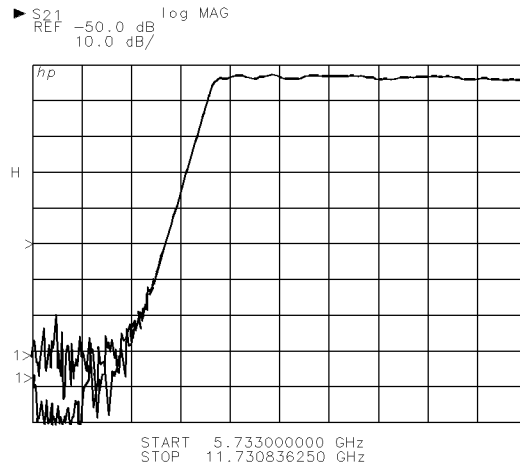

Figure 4-29. Results of Averaging

Smoothing

Smoothing operates on Cartesian data formats in much the same way as a video filter operates, producing a linear moving average of adjacent points. The selected smoothing aperture is displayed in percent of sweep width, as shown in Figure 4-30.

When smoothing is applied to the trace the **S** enhancement annotation appears. The smoothing aperture (the width of the linear moving average) is displayed in Hz, seconds, or volts, depending upon the domain selected. When Smith or polar display formats are selected, the trace data is not smoothed however, the smoothing aperture is displayed.

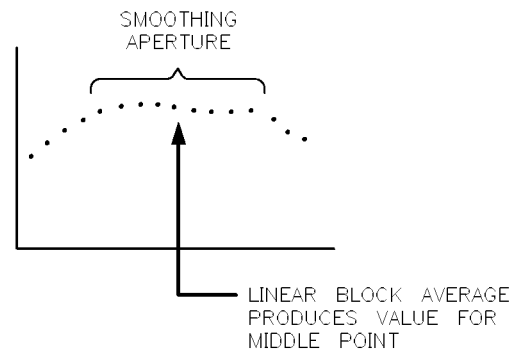

Figure 4-30. Smoothing Operation

Smoothing is especially useful in group delay measurements because it allows the response to be measured using small frequency steps (for high phase resolution). Then you can display data using an aperture that is appropriate for the measurement. Figure 4-31 shows this.

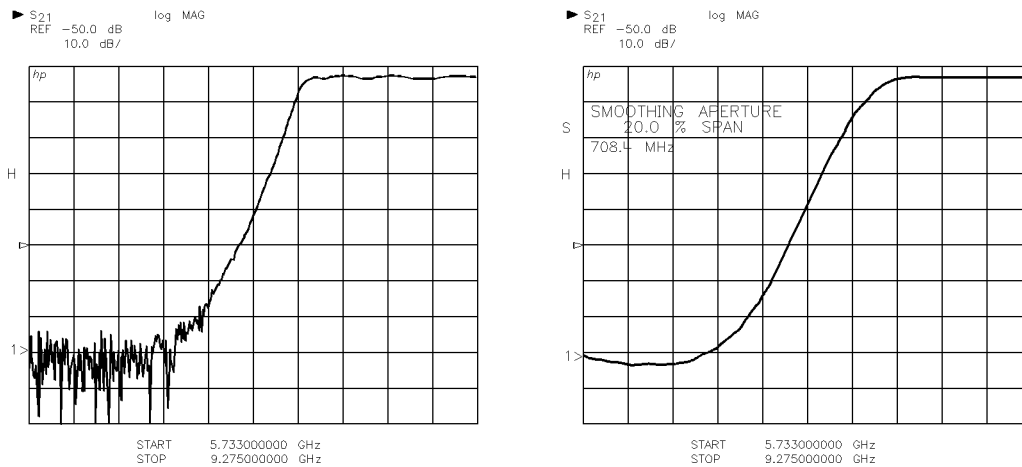

Figure 4-31. Results of Smoothing

Electrical Delay

The electrical delay function acts as an electronic line stretcher, providing a calibrated phase compensation versus frequency with femtosecond resolution. In effect, the specified delay is added to the reference signal path in order to make measurements such as deviation from linear phase, described later in “Transmission Measurements.” Electrical Delay can be set independently for each parameter on each channel and affects both the phase and delay frequency domain trace and the time domain trace.

Using Electrical Delay

Press **ELECTRICAL DELAY**. The Active function shows electrical delay in terms of seconds, with the supplementary display below showing the equivalent length in meters relative to the current Velocity Factor setting. After Factory Preset, this is relative to the speed of light in free space.

For example, select **(PHASE)**, and then use the knob to change the value. Notice that when delay is added, the D enhancement annotation appears on the left side of the LCD/CRT. You can use the step keys and the numeric and units keys to enter the amount of electrical delay desired.

Delay Features

Press **RESPONSE (MENU)**, then **MORE** and notice the three choices:

- **COAXIAL DELAY**
- **WAVEGUIDE DELAY**
- **TABLE DELAY**

Coaxial and Waveguide softkeys allow you to select the media type simulated by the electrical delay function.

RESPONSE Functions

Coaxial Delay. Factory Preset selects **COAXIAL DELAY** which applies a linear phase compensation to the trace. That is, the effect is the same as if a corresponding length of perfect vacuum dielectric coaxial transmission line was added to the reference signal path.

Waveguide Delay. Selecting **WAVEGUIDE DELAY** applies a non-linear phase shift which follows the standard dispersive phase equation for rectangular waveguide. When **WAVEGUIDE DELAY** is pressed the active function becomes the **WAVEGUIDE CUTOFF** frequency, which is used in the phase equation. Choosing a Start frequency less than the Cutoff Frequency results in phase errors.

Table Delay. The **TABLE DELAY** selection allows an array of real,imaginary data pairs input by the user via the GPIB to be applied to the data for the selected channel. Selecting **TABLE DELAY** disables Electrical Delay, Phase Offset, Magnitude Slope, Magnitude Offset, and the Port 1 and Port 2 Extensions. This array must be loaded using GPIB (see description in the Programming section of this volume), then the table may be stored and loaded using the disc drive.

Selecting Velocity Factor. The relative velocity factor of propagation can be selected. Press **CAL**, **MORE**, **PORT EXTENSIONS**, then **VELOCITY FACTOR**. The active function is now Relative Velocity Factor. After Factory Preset, this value is 1.0 which is the equivalent of the speed of light in free space (2.997925×10^8 meters per second). The range of the relative velocity factor is 0.001 to 500, with values less than 1 indicating that the propagation velocity is less than the speed of light in free space.

For example, the relative velocity is 1 divided by the square root of the dielectric constant for the media, ϵ_r . For air dielectric coaxial lines and waveguide media in standard air, the dielectric constant is about 1.00064, giving a relative velocity factor of about 0.999680.

Changing the velocity factor changes only the supplementary distance readout.

Auto Delay

The **AUTO DELAY** key automatically selects the appropriate value of electrical delay to balance the reference and test signal path lengths to find the electrical length of the test device. This results in a reasonable balanced (flat) phase trace at the marker position. When you press **AUTO DELAY**, the phase values at the marker position and the two adjacent points are sampled and electrical delay is added in order to make the phase constant. You may then make fine adjustments of Electrical Delay to achieve the desired trace.

Phase Offset

The phase offset function adds a fixed phase shift to each frequency point of the current selected trace. It also changes the marker value, but does not affect the group delay measurement. Phase offset can be set independently for each parameter in each channel.

Note Do not use phase offset with the Time Domain conversion.

When the phase offset value is other than 0 degrees for the current parameter, the D enhancement annotation appears on the left side of the LCD/CRT to indicate that phase offset is applied to the current trace.

Magnitude Slope and Magnitude Offset

Magnitude slope and magnitude offset produce an effect on the displayed Frequency Domain and Time Domain traces. Magnitude slope adds a magnitude offset that begins at 0 dB at 0 Hz, increasing by the selected dB/GHz over the frequency sweep. Magnitude offset adds a constant magnitude value to each frequency point. A non-zero value for either function causes the D enhancement annotation to be displayed.

Reasons for using magnitude slope and offset include viewing:

- Deviation from constant magnitude.
- Compensation for magnitude loss versus frequency.
- Compensation for insertion of a series attenuator in the test setup.

Stimulus

STIMULUS block keys and the associated stimulus menus allow complete control of the source in network measurement applications from the network analyzer front panel. The **START**, **STOP**, **CENTER** and **SPAN** keys are used to set the frequency parameters. The STIMULUS **MENU** key displays the top level stimulus softkey menu on the LCD/CRT, which provides you control over other source characteristics such as:

- Sweep time
- Number of data points taken during the sweep
- Source RF power
- Sweep modes
- Trigger modes
- S-parameter test set attenuation
- Source power flatness calibration

In multiple source applications, the stimulus frequency settings are made using these Stimulus controls and the Edit Multiple Source menu under the **SYSTEM** key. For Multiple Source operation, refer to the SYSTEM section of this document.

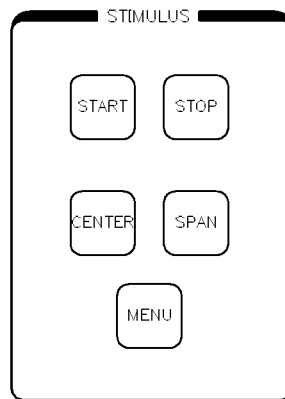

Figure 4-32. STIMULUS Function Block

Set Frequency Sweep

To set the frequency sweep, use the **START** and **STOP** keys or the **CENTER** and **SPAN** keys. Enter actual values using the knob, numeric, step, and units keys in the ENTRY block.

To familiarize yourself with the source controls, press **START**, **STOP**, **CENTER**, or **SPAN**, and observe the current value on the LCD/CRT in the active function area. Use the ENTRY block keys to change the value. When you rotate the knob or press a step key, the value is updated and the instrument state is changed immediately. Enter a specific value using the numeric pad by pressing the numeric keys, then terminate the entry by pressing one of the units terminator keys. When you press one of the units keys, the value is entered and the system is set to the specified value.

For example, to change the start frequency to 2 GHz, press **START**, then **2**, then the **G/n** units key. Or press **2 0 0 0**, then press the **M/u** key; the effect is the same. To correct errors made during entry, use the **BACKSPACE** key.

If you press **START** or **STOP**, the Start/Stop display mode is selected and you can set the start or the stop frequency. If you press **CENTER** or **SPAN**, the center/span display mode is selected and you can set the center frequency or the span width. Note that as you switch between start/stop or center/span sweeps, the frequency settings of the source are not changed, only the stimulus labels.

The range of possible frequency settings depends on the frequency limits of the source and of the test set used. The range of values for other functions allowed is determined by internal network analyzer logic.

Set Sweep Using Markers

Another way to set the sweep is by using a measurement marker. Here's how:

1. Use the knob to position the marker anywhere on the trace.
2. Press any of the three keys: **START**, **STOP**, or **CENTER**.
3. Press the **=MARKER** key in the ENTRY block. The value at the point where the marker is positioned now becomes the new start, stop, or center frequency.

Set Stimulus Power

There are two considerations for obtaining best accuracy and dynamic range:

- Stimulus signal level at the test port (what is the maximum and minimum incident signal level required for measurement of the device under test).
- Signal levels at the receiver input (what are the maximum and minimum signal levels required at the reference and test inputs).

The signal level at the test port must be appropriate for measurement of the device, and the inputs to the frequency converters must be appropriate to achieve the desired dynamic range.

You can estimate the signal level available at the test port by estimating the losses in the various signal paths of the test set, or by direct measurement using a power meter. Signal levels at the first frequency converters can be measured directly by the network analyzer by means of the USER parameters under the Parameter menu.

Setting and Monitoring Signal Levels

The following paragraphs describe controls for setting and monitoring signal levels.

STIMULUS Functions

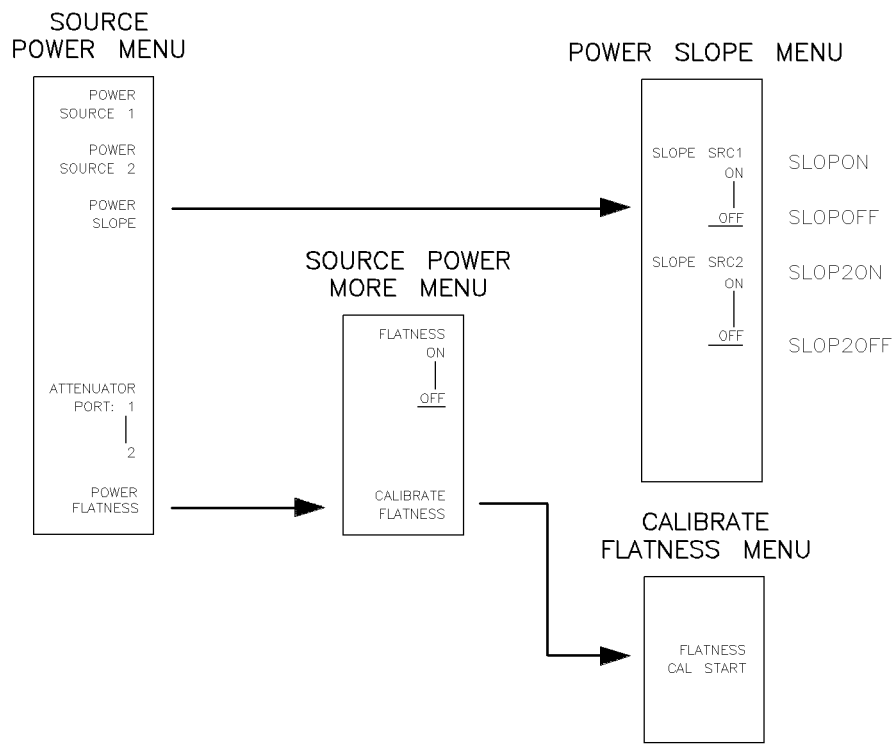

Figure 4-33. Source Power Menu

Set Source RF Output Level. The **SOURCE POWER 1** softkey allows you to set the source output level at its RF OUTPUT connector. After Factory Preset, the source RF power level is set to an appropriate value, usually +10 dBm. In most applications for measurement of passive devices, this level does not need to be changed.

Note Be careful not to exceed the *damage power level for the test set's inputs*.

When changing output signal level of the source, caution should be observed because power levels above +20 dBm may damage the test set.

Note Be aware of your source's *maximum power output, especially at higher frequencies*.

Lower levels also depend on the source capabilities; the source may not be able to achieve the selected power for all frequencies. Maximum power from RF sources is generally less at higher frequencies. If the source's UNLEVELED indicator comes on, you are requesting more power than the source can produce across the selected frequency band. In general, it is not harmful for the source to operate *unleveled* and does not affect most measurements because they are usually ratioed. However, for applications using the flatness correction features, operating with the source unleveled gives incorrect results and causes warning messages to appear. Before changing power levels, consult the specifications for the source and the test set.

If you have decided to change the source RF power level, use the Source Power menu as follows:

4-58 Measurement Controls

1. Press STIMULUS **(MENU)** **POWER MENU** **POWER SOURCE 1**. The current value appears as the active function.
2. Use the ENTRY block controls to set the new source power level. Press the **(x1)** key to set the source RF power in dBm.

Messages appear on the LCD/CRT if the source power level selected is too low or too high for proper network analyzer operation:

IF OVERLOAD indicates that the power level is too high.

PHASE LOCK LOST, NO IF FOUND, VTO FAILURE, or similar messages indicate that power is too low.

Remember that **(ENTRY OFF)** must be pressed to clear an error message; it does not go away automatically when you correct the problem.

Please note that all keys associated with a second source apply to Multiple Source applications and are described later.

Power Slope On/Off. The source output is internally leveled at its RF OUTPUT port, but it is also possible to set the amount by which the source RF power level is increased or decreased from the base level over the sweep. Generally, this power slope function is used to increase the source output power at higher frequencies in order to compensate for losses in the test setup and thus preserve dynamic range.

Pressing the softkey **POWER SLOPE** then **SLOPE SRC1 ON** turns on the power slope function and the source is commanded to start the sweep at the value set by the **POWER SOURCE 1** function, then increase or decrease the output signal level by the displayed dB/GHz value as the sweep progresses. Press the softkey labeled **SLOPE SRC1 OFF** to turn off the power slope function. Factory Preset selects slope off and 0.0 dB/GHz.

Attenuator Port: 1 and Attenuator Port: 2. Attenuator choices on the source power menu control the internal 0 to 90 dB, 10 dB/step attenuators in many test sets. Such attenuators are useful for reducing the incident signal level applied at the test set port without changing the level of the reference signal. The network analyzer attenuator functions do not operate when the S-Parameter test set is not equipped with the attenuators, or when a reflection/transmission test set is used. Even if there is no attenuator, the display indicates (falsely) that a change has been made.

Pressing the **PORT 1** or **PORT 2** softkey selects the attenuator affecting that port, and the attenuation value may be increased or decreased using the step keys. Note that if attenuation is changed while calibration is on, the message **Correction May Be Invalid** is displayed, warning you that the current correction factors may not apply. After Factory Preset, both Port 1 and Port 2 attenuators are set to 0 dB.

Setting power for passive devices, or devices with gain. After Factory Preset, the source power, power slope, and test set attenuation are appropriate for measurement of most passive devices. For measurement of devices having gain, increase the Port 1 attenuator by 10 dB for each 10 dB of device gain before connecting the device, to reduce the input level to the device, and thus keep its output level within limits. Messages **NO IF FOUND** (RF input too low) and **IF OVERLOAD** (RF input too high) appear if the input range is exceeded. More information on setting optimum signal levels of the source and test set for the specific device under test are given in the following Parameter section under “Dynamic Range Considerations.”

STIMULUS Functions

Source Power and Flatness Correction Calibration

This function enables the analyzer to set and control the power level at the test port. Flatness correction calibration compensates for path losses at each measurement frequency, as specified by the number of points. This function is only available to systems using an Agilent 8360 series synthesized sweeper.

To accomplish flatness correction, the analyzer controls an external power meter to measure test port power. A table of power corrections versus frequency is created and stored in register 1 of the source save/recall memory. When flatness correction calibration is enabled, the source produces for each frequency a corrected power level at the test port and the softkey **POWER SOURCE 1** controls the test port power level, *not* the RF input power into the test set. The source and test set used determine the available test port power range. The test port power levels must be set within the power range given in Table 4-8.

Table 4-8.
Typical Test Port Power Ranges for Source or Test Set Configurations

RF Source 8510 Test Set ¹	83620A/83621A		83631A	83651A	83651A	
	w/ 8514B	w/ 8515A	w/ 8515A	w/ 8517B	Set to +10 dBm	Set to -20 dBm
Frequency (GHz)	Test Port Power Levels [P_{max}/P_{min}] (dBm)					
0.05	+2.5 to -20.5	-3.5 to -26	-3.5 to -26	+1.5 to -21.5	+5	-21
2.0	+1 to -22.0	-6 to -29	-6 to -29	+0.5 to -23.5	+5	-21
20.0	-7.5 to -27	-13.5 to -30	-13.5 to -30	-7.5 to -30	+2	-23
26.5			-25 to -30	-13.5 to -30	+1	-24
40.0				-20 to -30	-3	-21.5
50.0				-27 to -30	-13	-29

¹ Data presented assumes no test-set step attenuation. Since the test port flatness correction feature cannot compensate for losses above 20 GHz with an 8516A, no data is provided.

Note Refer to *Product Note 8510-16* for a complete description of the operation of the flatness correction calibration feature.

Selecting the Number of Points to Measure

After a Factory Preset, the network analyzer selects 201 points per sweep. In Frequency Domain mode, this produces 200 equally spaced *frequency* intervals. To change the number of points:

1. Press STIMULUS (MENU) NUMBER of POINTS. This brings the number of points menu onto the display. The current value is underlined.
2. Press the appropriate softkey to select 51, 101, 201, 401, or 801 points. Sweep time increases when you choose a higher number of points.

NUMBER of POINTS MENU

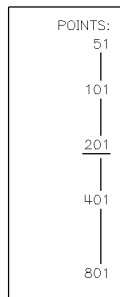

Figure 4-34. Number of Points Menu

Number of points is always coupled. Selecting the number of points for one channel automatically selects the same number of points for the other channel.

With broadband sweeps, responses that are narrow with respect to the frequency interval may not be accurately represented. For example, with a 10 GHz sweep width, the frequency resolution is:

Number of Points	Frequency Resolution (10 GHz Span)
51	200 MHz
101	100 MHz
201	50 MHz
401	25 MHz
801	12.5 MHz

This means that with 51 points selected, responses that are narrower than 200 MHz are not represented accurately using a 10 GHz sweep width. Figure 4-35 shows the effect of changing the number of points from 51 to 401 in such a measurement.

STIMULUS Functions

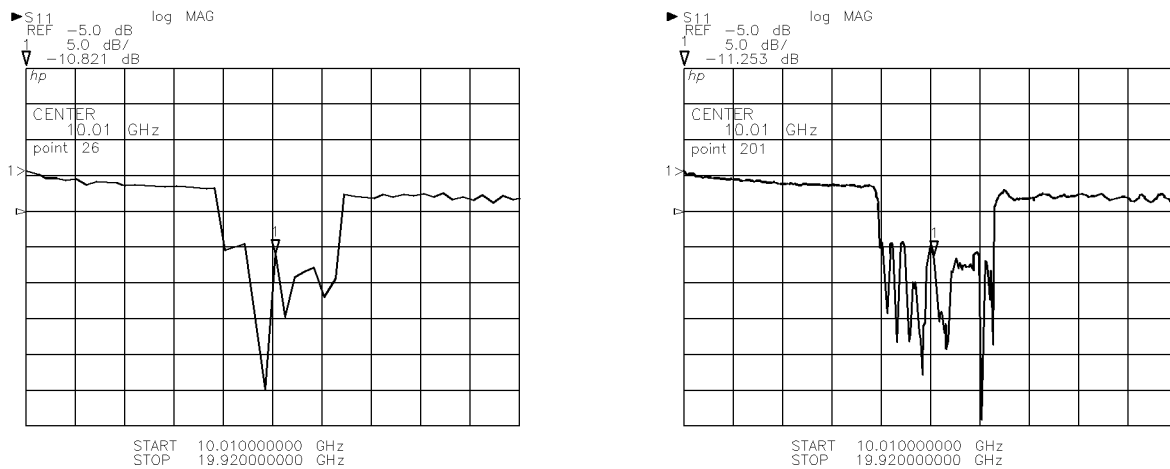

Figure 4-35. Narrowband Responses

Source Sweep Modes

Four source sweep mode selections are available on the stimulus menu.

RAMP

The Ramp mode is the fastest data acquisition mode. The source is swept in a continuous analog sweep from the lower to upper frequency and the data is sampled without stopping the sweep. This mode is available with either a sweeper source or a synthesized sweeper source.

For Agilent 835x sources, this selects the standard analog sweep with open loop YIG oscillator tuning accuracy and repeatability.

For Agilent 834x sources, this selects standard analog “lock and roll” sweep. The source is phase-locked at all frequencies for less than 5 MHz sweep widths.

For Agilent 8360 sources, this selects *enhanced* analog “lock and roll” sweep. The source reads its frequency at the end of the first sweep and adjusts the slope and offset of the 0 to 10 V sweep voltage ramp so that subsequent sweeps are more accurate. The analyzer processes the first sweep (referred to as the “learn” sweep) at a slightly slower rate than the subsequent sweeps. This is why the data may change slightly from the first sweep to the second and subsequent sweeps.

STEP

The source is tuned and phaselocked at each frequency point. This mode is available only with synthesized sources. You can select two speeds for step mode using controls in the **SYSTEM** menu. The types are **STEP TYPE NORMAL** and **STEP TYPE QUICK**. Quick Step mode is not a function for systems using multiple sources.

SINGLE POINT

Sets the source to the center frequency of the sweep already selected in the ramp or step sweep mode. Single point mode measures only one point of data. Displaying one point of data on the screen would result in one little dot in the middle of the display. To make the signal level easier to view, the system duplicates the data to create a flat horizontal line

that goes across the entire display. All points of the trace are replicated from the first, original data point.

FREQUENCY LIST

Allows you to enter a list of frequencies for measurement. For sweeper sources, the source is set to its CW mode and tuned to each frequency point in the list. For synthesized sweeper sources, the source is phase-locked at each frequency point, as in the step sweep mode.

To select the source mode:

1. Press STIMULUS **(MENU)**. The current source mode is underlined.
2. Use the corresponding softkey to select the source mode: **RAMP** **STEP** **SINGLE POINT** or **FREQUENCY LIST**.

You may switch between ramp, step, single point, and frequency list modes at any time.

STIMULUS MENU

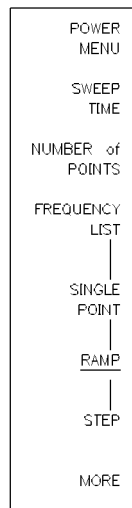

Figure 4-36. Sweep Mode Menu

Speed of Step and Frequency vs. Ramp Modes

Using less than about 100 averages, taking one sweep in the step sweep mode or the frequency list mode takes about the same time as about 100 sweeps in the ramp mode. Notice that measurement time at each step or frequency list data point is not visibly affected until the averaging factor is increased above about 100.

Measurement Hint

Often, in applications requiring highest accuracy, measurement data is examined using ramp sweep with a small averaging factor. This has the advantage of the fast update. Then step mode is activated with increased averaging for the final measurement. This provides the accuracy benefit of improved frequency accuracy.

Entering Ramp, Step, and Single Point Stimulus Values

For ramp and step sweep modes, enter the frequency span using the **(START)**, **(STOP)**, **(CENTER)**, and **(SPAN)** controls. To select another frequency in the single point mode, press **(CENTER)** and the annotation C.W. will appear in the active entry area. Now enter the new frequency desired

STIMULUS Functions

using the knob, step, or numeric keys. If the frequency list mode is selected and a frequency list has not been created, the message **FREQUENCY LIST EMPTY** appears and the sweep mode is not changed.

Sweep Time

The **SWEEP TIME** softkey in the stimulus menu allows you to change the amount of time it takes to complete a frequency sweep. If you have selected step sweep or frequency list mode, sweep time changes to dwell time and the softkey label is **DWELL TIME**. Dwell time is the amount of time the analyzer waits before measuring the data after the source is settled at the frequency point in the frequency list. To change the sweep time:

1. Press **STIMULUS** (**MENU**), **SWEEP TIME**. The current value appears in the active entry area. The 8510 automatically selects the minimum recommended sweep time, unless increased by the user.
2. Use the **ENTRY** block controls to set the new sweep time where the units terminator key (**x1**) = seconds and (**k/m**) = milliseconds. In general, depending upon the frequency span, the best ramp mode frequency accuracy and repeatability is achieved with sweep times from 300 to 500 milliseconds per sweep.

If the sweep time/dwell time selected is faster than the DUT response time, a distorted measurement response is obtained. Distortion of the trace or an error message indicates that the sweep is too fast. In general, the optimum sweep time can be determined using:

$$\text{Sweep Time (s)} > [\text{Span (GHz)} \times \text{Group Delay (ns)}] / 100$$

The length of the dwell time can be determined by using:

$$\text{Dwell Time (ms)} = \text{Sweep Time (ms)} / (\text{Number of Points} - 1)$$

Select the fastest possible sweep time or the shortest possible dwell time that does not result in distortion of the trace. In the ramp sweep mode, the standard Preset state selects a sweep time of 166.0 ms/sweep for 51, 101, 201, and 401 points, or 184 ms/sweep for 801 points.

For narrowband devices, when the sweep width is wider with respect to the device response, an overly fast sweep time can distort the response of the device under test because the device does not have time to respond fully to the stimulus signal. If so, the trace changes when the sweep time is slowed. This example measurement illustrates the effects of an overly fast sweep time.

Example: Effects of Sweep Time

A good way to see the effects of changing sweep times is to measure a device whose response changes rapidly with frequency. A narrow-bandwidth device such as a crystal filter or an electrically long device such as a long cable are good examples.

1. Set up the measurement and notice the appearance of the trace at the Preset sweep time.
2. Store this trace in memory by pressing (**DISPLAY**), **DATA AND MEMORIES**, **DISPLAY: DATA and MEMORY**.
3. Then use the stimulus menu to set the sweep time to 110 milliseconds/sweep.
4. Compare the new trace to the original. Store this new trace by pressing (**DISPLAY**), **DATA AND MEMORIES** and change the sweep time again.

- Repeat this process until you reach the fastest possible sweep time with no change in appearance of the trace. This is the optimum sweep time for that device using that frequency span and number of points.

Details of storing and comparing traces are given earlier in this chapter in the “Trace Memory Operations” section.

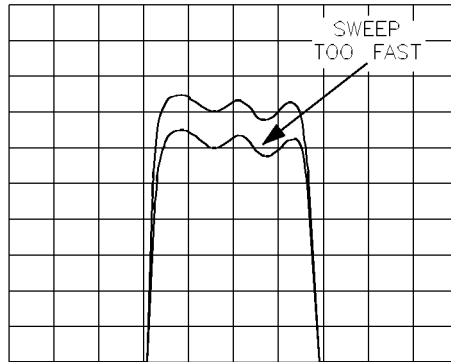

Figure 4-37. Effects of Sweep Time

Sweep Execution, Hold/Single/Number of Groups/Continual

The Factory Preset condition selects **CONTINUAL** sweep; the network analyzer continually executes the sweeps required to produce a measurement. In this mode, the trace is continually updated.

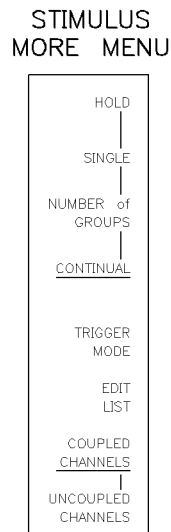

Figure 4-38. Hold, Single, Number of Groups, Continual

STIMULUS Functions

Three other choices are available on the continuation of the Stimulus menu. Press the STIMULUS **MENU** key, then **MORE**, to summon these choices:

HOLD stops updating the trace. Most processing functions can be changed while in this mode unless they require that additional sweeps be taken. When in this mode, the enhancement annotation H appears on the LCD/CRT.

SINGLE first executes a measurement restart. A single group of sweeps is taken, and then **HOLD** is selected automatically. The H annotation appears on the LCD/CRT.

NUMBER of GROUPS initiates a specific number of measurement sweeps, then places the instrument in Hold mode. To enter a number of groups, press **NUMBER OF GROUPS** followed by a numeric entry and **x1**. Entering a number of groups automatically forces a measurement restart.

After the group is finished, an H appears in the annotation area, showing that the analyzer is in Hold mode. You may restart the number of groups at any time by entering a number and pressing **x1**.

To resume continuous operation, press **CONTINUAL** at any time.

Why Use Number of Groups?

A group of sweeps consists of the number of frequency sweeps necessary to present data for the current measurement. For example, if in ramp sweep mode with averaging on, the trace is fully averaged by $n+1$ groups of sweeps, where n is the averaging factor. In this way Number of Groups can be used to signify that the measurement is complete. If the Averaging Factor is 16, then press **NUMBER of GROUPS**, enter **17**, **x1**. When the measurement is complete, Hold is selected.

Using step sweep or frequency list with an S-Parameter test set, 1 sweep always equals 1 group because all necessary data is taken at each frequency step. Regardless of the averaging factor you may enter **NUMBER of GROUPS**, **1** **x1** for this configuration.

Coupled/Uncoupled Channels

Almost all features in the network analyzer are uncoupled, this allows each channel to act like completely different analyzers. All stimulus settings, however, are normally coupled—they remain the same when you change channels. The instrument couples many stimulus functions because it is usually more convenient to use this way. For this reason, Factory Preset selects the **COUPLED CHANNELS** mode. All stimulus functions are identical for both channels.

The network analyzer allows you to uncouple most stimulus functions, so you can have different stimulus settings when you change channels.

Some stimulus functions are *always* coupled and cannot be set independently. These functions are:

Sweep Modes: Ramp, Step, Single Point, Frequency List Frequencies, Hold, Single, Number of Groups, Continual, Number of Points.

Marker Functions: Active markers and reference markers.

How to tell if a function is coupled. To determine if any given function is coupled or uncoupled, make it the active function. Press **CHANNEL 1**, change the function value, and then press **CHANNEL 2**. If the active function value shown for Channel 2 has also changed, the two channels are coupled. Otherwise the function is always uncoupled and can be set independently.

Selecting **UNCOUPLED CHANNELS** makes it possible to set some stimulus functions independently for each channel. These functions are:

- Start/Stop/Center/Span
- Source Power
- Power Slope
- Sweep Time
- Trim Sweep
- Correction On/Off
- Cal Set

Dual Channel

Another control related to measurement channel selection and uncoupled channels is “dual channel.” When a dual channel display mode has been selected, the current selected measurement is displayed. If possible, the measurement for both channels is made by a single frequency sweep, or else the channels are measured alternately. Pressing **CHANNEL 1** or **CHANNEL 2** selects the channel that is controlled by the front panel. Note on the display, the ► annotation next to the parameter identifier indicating the active channel.

To change to a dual channel display mode, press **DISPLAY DISPLAY MODE**; select either **DUAL CHAN OVERLAY** or **DUAL CHAN SPLIT**.

Uncoupled Stimulus Settings and Dual Channel Displays. For dual channel displays, separate stimulus values for each channel are displayed below the graticule area. These stimulus values can be changed independently by pressing **CHANNEL 1** or **CHANNEL 2**, then setting the stimulus values for that channel in the usual way.

To set different stimulus functions for Channel 1 and Channel 2:

1. Press **STIMULUS MENU**, **MORE**, **UNCOUPLED CHANNELS**.
2. Press **CHANNEL 1**. Set the Start/Stop or Center/Span frequencies for Channel 1 using the **STIMULUS** keys.
3. Press **CHANNEL 2**. Set the Start/Stop or Center/Span frequencies for Channel 2 using the **STIMULUS** keys.
4. Press **DISPLAY DUAL CHANNEL OVERLAY** or **SPLIT**.

When you select **COUPLED CHANNELS**, the stimulus values for both channels are set to the current values of the selected channel. For example, select **CHANNEL 1** or **CHANNEL 2**, then press **COUPLED CHANNELS**. Both channels now have the same stimulus values.

STIMULUS Functions

Trigger Modes

Three softkeys control the data acquisition triggering for the analyzer system:

TRIGGERING INTERNAL, **TRIGGERING EXTERNAL** and **TRIGGER DELAY**. The internal trigger control sets the acquisition cycle to synchronize with the source frequency ramp output. This is the Factory Preset setting.

TRIGGERING EXTERNAL sets the data acquisition cycle to synchronize with an external trigger provided at the rear-panel connection, TRIGGER IN. This allows synchronization with an event other than the source frequency sweep.

TRIGGER DELAY allows you to set the data acquisition point at a spot delayed from the leading edge of the trigger pulse. The delay time for internal trigger equals zero seconds when the signal at the rear-panel PULSE OUT connector is asserted. You can set the delay for a time before zero seconds (negative time delay) to 40.88 ms after the pulse output signal is asserted. For external triggering, time zero is at the falling edge of the signal at the TRIGGER IN connector. You can set the delay for times after the time zero up to 40.88 ms. For internal and external triggers, the range of delay times allowed are dependent on the pulse width and the number of points measured. Trigger delay range in external triggering is also dependent on the stop time.

Trigger delay is active only in Frequency Domain measurements and is normally used for pulsed-RF applications. Refer to the *Pulsed RF-Measurements User's Guide* (tabbed section GENERAL APPLICATIONS) for more information on triggering applications.

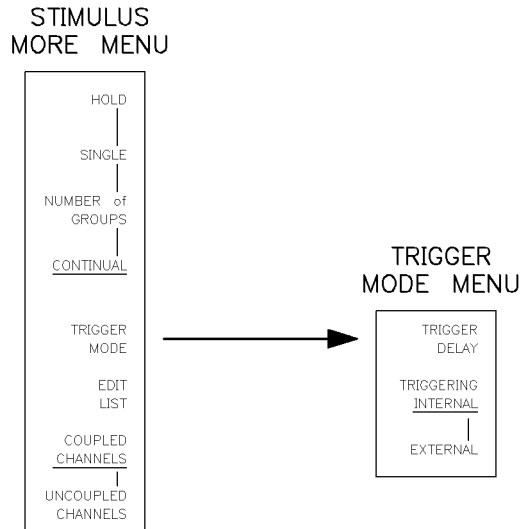

Figure 4-39. Trigger Mode Menu

Creating a Frequency List

Frequency list provides the capability to measure only specific frequencies of interest. The frequency list is made up of segments and each segment may consist of a single CW frequency or a frequency span. The span may be specified using start/stop or center/span frequencies and either a frequency step or number of points.

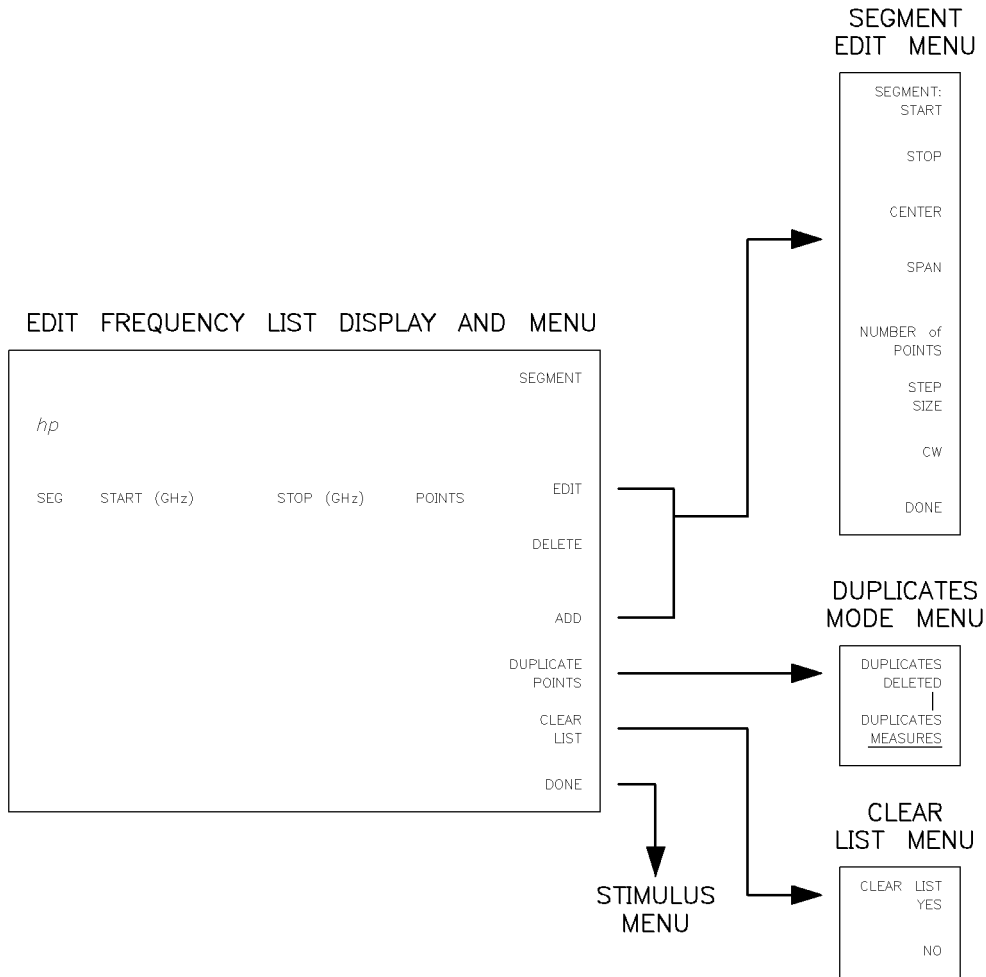

Figure 4-40. Frequency List Menu Structure

Entering the First Segment

To create a frequency list:

1. Press STIMULUS **MENU**, **MORE**, then **EDIT LIST**. The LCD/CRT appears as shown here.
2. Press **ADD**. The first segment appears as shown here.
3. Press **SEGMENT: START** and enter the start frequency of the first segment.
4. Press **SEGMENT: STOP** and enter the stop frequency of the segment.
5. Press **SEGMENT: STEP SIZE** and enter the frequency step.

STIMULUS Functions

- Press **SEGMENT: DONE**. Now press **DONE** again to return to the main stimulus menu, then press **FREQUENCY LIST**. The LCD/CRT frequency annotation is updated to the limits of the frequency list and the sweep of the frequency list begins.

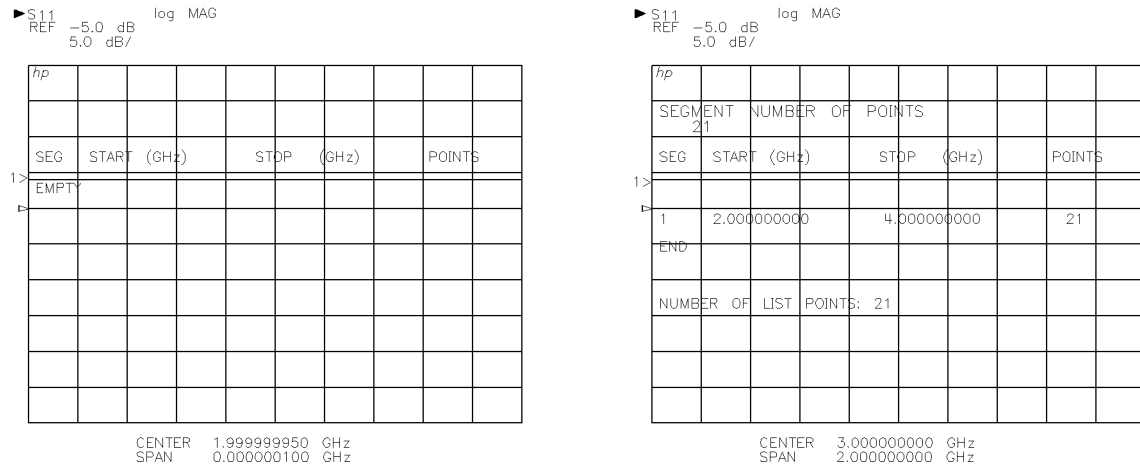

Figure 4-41. Enter the First Segment

Add Segments

To add a segment to the list:

- Press **EDIT LIST**, then press **ADD**. Each time you press **ADD**, the current segment is duplicated.
- Enter new segment values by following the instructions given previously, then press **SEGMENT: DONE**.

The segments do not have to be entered in any particular order. They are sorted automatically by start or CW frequency each time you press **SEGMENT: DONE**. If you try to add more than the maximum allowed number of segments or frequency points, a warning message is displayed.

Editing the Frequency List

Changing a Segment. To change the contents of the list, press **EDIT LIST** to display the edit frequency list menu, press **SEGMENT** to choose a segment, then press **EDIT**.

The **SEGMENT** key determines the segment to be edited or deleted. Press **SEGMENT**, then enter the number of the segment in the list or use the knob or step keys to scroll the pointer > to the segment number. Press **EDIT** to edit the current segment. The segment edit menu appears, allowing you to change any of the segment characteristics.

Please note that the **(START)**, **(STOP)**, **(CENTER)**, and **(SPAN)** keys in the STIMULUS block are not used during the frequency list editing process.

For example, enter a frequency list as follows:

- Press STIMULUS **(MENU)**, **MORE EDIT LIST**.
- Press the following keys:

4-70 Measurement Controls

- a. ADD SEGMENT: START 2 (G/n)
- b. SEGMENT: STOP 4 (G/n)
- c. SEGMENT: STEP SIZE 100 (M/ μ)
- d. SEGMENT: DONE DONE FREQUENCY LIST

The frequency list sweep starts.

In the frequency list mode, you may edit the segments interactively. When you press **SEGMENT: DONE**, the frequency list segments are arranged in ascending order and the measurement begins.

Deleting a Segment. When you press **DELETE**, the current segment is deleted.

Adding a Segment. Now add a segment to the list as follows:

1. Press STIMULUS (MENU) MORE EDIT LIST.
2. Press the following:
 - a. ADD SEGMENT: START 4 (G/n)
 - b. SEGMENT: STOP 8 (G/n)
 - c. SEGMENT: STEP SIZE 200 (M/ μ)
 - d. SEGMENT: DONE

The sweep restarts and the new list is measured.

To Duplicate Points

If you followed the above sequence, notice that the point at 4 GHz is brighter. This is because it is being measured and plotted twice. If you select the delay format, you can see that the group delay trace shows an unexpected discontinuity at the duplicated point. Later, in the discussion of the COPY menu, you will see that you can print the list of measured frequencies and values in tabular format. If you performed this operation, you would see that 4 GHz is listed twice. If this is an undesired duplication, press **DUPLICATE POINTS**, then **DUPLICATES DELETED**. The sweep is restarted and any duplicate point is measured only once.

Frequency List Save and Recall

Of course you may save the current frequency list in the same way as any instrument state is saved, by using the **SAVE** and **RECALL** keys.

Selecting All Segments or a Single Segment. It is very convenient to define all segments of the frequency list, perform the measurement calibration, then select a single segment for viewing. This simplifies measurement calibration because all segments are calibrated with a single connection of the standards, and speeds the measurement process because you can examine only the segment of interest for the current test.

When you press **FREQUENCY LIST** with more than one segment defined, the menu allows selection of either **ALL SEGMENTS** or **SINGLE SEGMENT**. Press **SINGLE SEGMENT** to cause the current selected segment to become the active segment and the network analyzer to measure that segment. Use the step keys, knob, or numeric entry to select the segment for measurement.

STIMULUS Functions

Figure 4-42 shows the display when the complete frequency list is swept, then after a single segment is selected. The current listing of frequency list segments is displayed with the arrow pointing to the current segment. If you do not want the frequency list displayed, press STIMULUS **(MENU)**. It disappears but segment number remains the active function. Note that the Stimulus values at the bottom of the screen show the actual frequency range being measured and that Correction remains On.

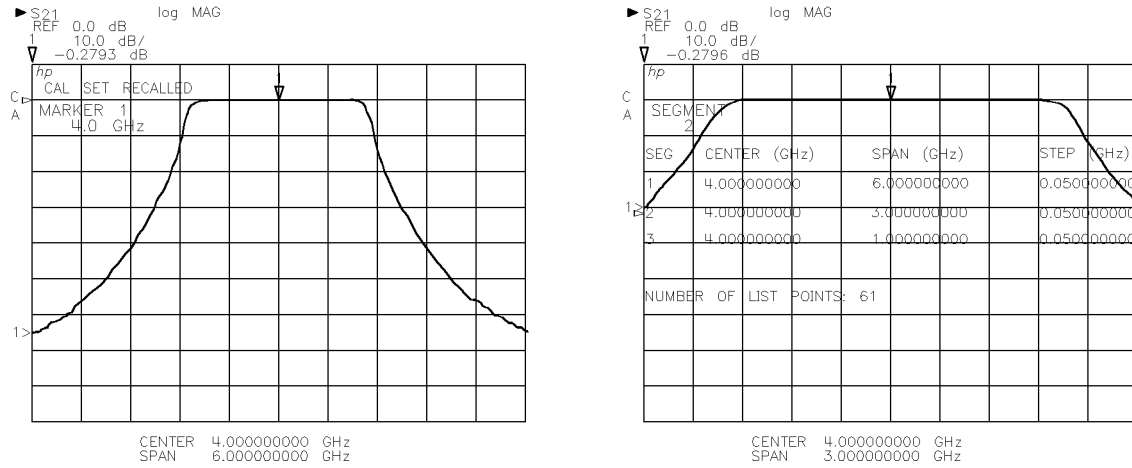

Figure 4-42. Frequency List, Display of Single Segment

To Exit Frequency List

To exit the frequency list mode, press STIMULUS **(MENU)**, then press **RAMP**, **STEP**, or **SINGLE POINT**. The frequency endpoints of the frequency list are used for the ramp or step sweep.

FACTORY PRESET clears the frequency list and selects **DUPLICATES MEASURED**.

Using System Functions

Chapter Contents

The topics covered in this chapter are listed below:

- System Menus
- Controls That Affect the Network Analyzer
 - Phaselock Controls
 - Warning Beeper
 - IF Calibration and Correction
 - Display Functions (Creating a Title, Adjusting the Date/Time Clock)
 - Security Features
- Controls that Affect I/O
 - GPIB Addresses
 - Power Leveling
 - Controlling Multiple Sources (Multiple Source Menu/Mode)
- Service Functions

System Menus

Figure 5-1 shows the main System menu.

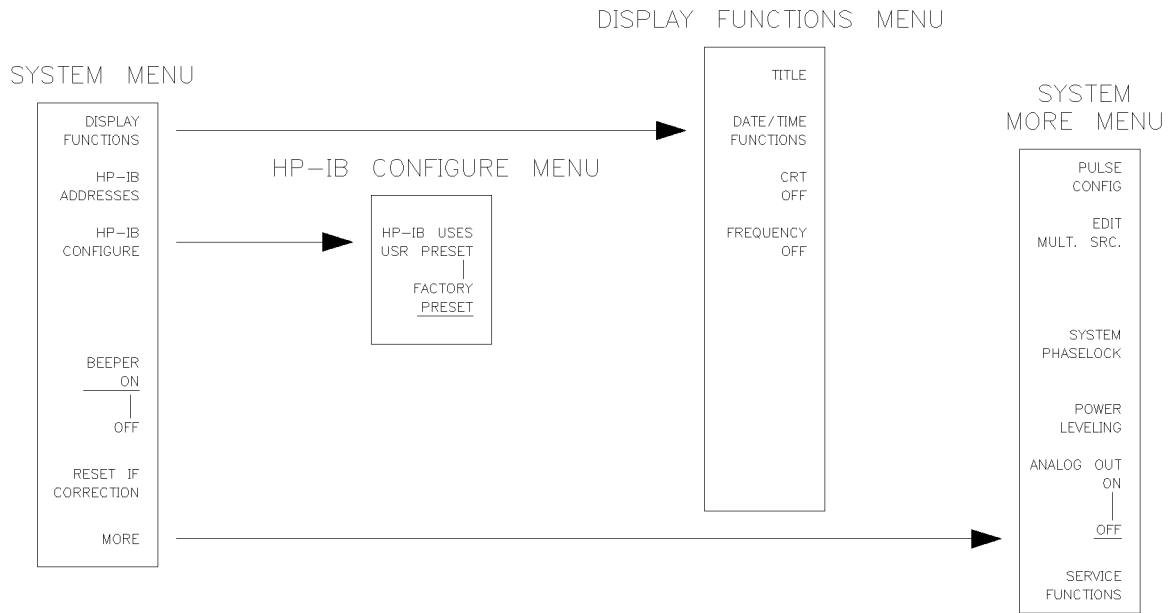

Figure 5-1. Main System Menu and Part of the Display Functions Menu

Controls that Affect the Network Analyzer

The following features affect only the network analyzer:

Phaselock Controls

Press **SYSTEM** **MORE** **SYSTEM PHASELOCK** to access the System Phaselock Menu, shown in Figure 5-2. The functions of this menu control the timing of data acquisition cycle and the point where the system is phaselocked.

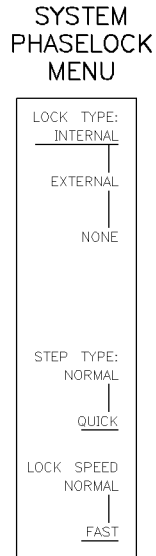

Figure 5-2. System Phaselock Menu

Lock Type

Press **SYSTEM** **MORE** **SYSTEM PHASELOCK** to access **LOCK TYPE: INTERNAL** or **LOCK TYPE: EXTERNAL**.

- EXTERNAL lock type selects the system first IF phase lock, and phase locks on an external LO source.
- INTERNAL lock type selects the system first IF phase lock, and the internal LO source.
- NONE turns phaselock off.

Step Type

Press **SYSTEM** **MORE** **SYSTEM PHASELOCK** to access the Step Type softkeys.

The step type softkeys control the data acquisition cycle during Frequency Domain measurements. There are two step types: Normal Step and Quick Step. Normal Step is the factory default mode. Once changed by the user, this mode never changes. The mode you choose, either Quick Step or Normal Step, affects measurements made in the Step or Frequency List sweep modes.

Controls that Affect the Network Analyzer

Normal Step. Press **(SYSTEM) MORE SYSTEM PHASELOCK STEP TYPE: NORMAL** to select Normal Step mode.

In normal-step, the network analyzer tunes to a frequency and measures all necessary parameters before breaking phaselock and tuning to the next frequency. The network analyzer goes through a complete phaselock sequence at each frequency step.

This method of phaselock requires a software handshake only (occurs through the System Bus). No other external connectors between the source and network analyzer are required, and GPIB extenders can be used.

Quick Step Mode. Press **(SYSTEM) MORE SYSTEM PHASELOCK STEP TYPE: QUICK** to select Quick Step mode.

In Quick Step, the source is tuned from one measurement to the next in small steps allowing the receiver to track the source without breaking phaselock. Since the time required for the receiver to achieve phaselock is a major portion of the measurement cycle time for each point, Quick Step mode increases the speed of Step sweep measurements up to six times with no penalty in the frequency accuracy and repeatability specifications. Quick Step requires a compatible 836xx source. The *Agilent 8510C On-Site Service Manual* provides a list of compatible 836xx sources.

Note Quick Step mode does not function in a system that uses multiple sources.

The key attributes of the quick-step phaselock method are:

- Each data acquisition point is fully synthesized.
- The source is “tuned” from point-to-point; it does not break phaselock.
- The network analyzer remains phaselocked to the source except at the source bandcross points or when the test VTO needs to reset.
- The network analyzer and source require two BNC connections, described below.
- Typically (depends on averaging), increased data acquisition speed (six times improvement) is achieved by this method of phaselock.

The 8510C uses **STEP TYPE: NORMAL** if the source is not compatible with quick step. Agilent 8340/41 sources are NOT compatible with quick step.

To use Quick Step mode with an Agilent 836xx RF source:

1. Connect the network analyzer’s TRIGGER IN BNC to the source’s TRIGGER OUT BNC.
2. Connect the network analyzer’s STOP SWP BNC to the source’s STOP SWEEP BNC.
3. Press **(SYSTEM) MORE SYSTEM PHASELOCK STEP TYPE: QUICK**.

Lock Speed

Press **(SYSTEM) MORE SYSTEM PHASELOCK** to access the Lock Speed controls.

LOCK SPEED NORMAL provides the best frequency accuracy when using Step, Single Point, or Frequency List modes. Lock Speed Normal is the factory default setting. This feature has no effect in Ramp Sweep mode.

5-4 Using System Functions

LOCK SPEED FAST allows you to increase stepped measurement speed with a tradeoff of decreased frequency accuracy. Fast Speed increases the speed of Step, Single Point, and Frequency List modes. This feature has no effect in Ramp Sweep mode.

Warning Beeper

The **BEEPER ON** or **BEEPER OFF** softkeys control whether you hear a “beep” whenever a warning message is displayed. The **BEEPER ON** selection is the factory default setting.

IF Calibration and Correction

IF calibration/correction is an automatic calibration feature that reduces IF gain and quadrature errors in each of the four input channels (a1, a2, b1 and b2). This process is composed of two features:

IF Calibration IF calibration measures a crystal reference signal, and determines gain and quadrature errors for each input channel. A series of error-correction coefficients are calculated. The network analyzer firmware determines how often IF calibrations should be performed. When the network analyzer is warming up, it performs IF calibrations often. When the network analyzer is fully warmed up, it performs IF calibrations less often.

Refer to Figure 5-12. To perform an IF calibration, the network analyzer measures a 100 kHz reference signal (from a built-in crystal oscillator) with the Test and Reference Synchronous Detectors. Then, IF calibration calculates gain and quadrature errors for each input channel.

The network analyzer inhibits periodic IF calibrations during Fast CW modes. You can force an IF calibration to be performed. Refer to the “IF Calibration Controls,” below, for instructions.

IF Correction *IF Correction* subtracts IF calibration error coefficients from the measurement data. *IF correction* is always ON. IF correction occurs before any other data processing, before data reaches the Raw Data Arrays.

IF Calibration Controls

Press **(SYSTEM) RESET IF CORRECTION** to have the network analyzer perform an IF calibrations now. Otherwise the network analyzer automatically performs IF calibrations at periodic intervals. The network analyzer modifies measurement data with the most-recent IF calibration coefficients.

Display Functions

Part of the display functions menu is shown in Figure 5-1, and the date/time functions menu is shown in Figure 5-3.

Creating a Title

To create or change a title, use the System function keys listed below:

1. Press **(SYSTEM), DISPLAY FUNCTIONS, TITLE** to display the title menu and the existing title.

Controls that Affect the Network Analyzer

2. To enter a character, position the ↑ (uparrow) symbol positioned below the character by turning the knob.
3. Press **SELECT LETTER**. The character appears as the last character in the title area. Repeat this process to write the rest of the title.
4. Use the **BACK SPACE** softkey to erase the first title character to the left of the arrow. When you have finished creating or changing the title, select the softkey labeled **TITLE DONE**.

Deleting a Title

To delete the whole title, press the softkey labeled **ERASE TITLE** or use the **BACKSPACE** key in the ENTRY block to erase one character at a time.

Adjusting the Date/Time Clock

DATE/TIME FUNCTIONS MENU

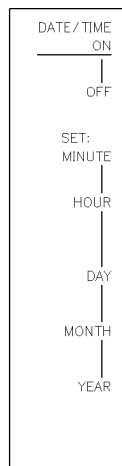



Figure 5-3. Date/Time Functions Menu

To adjust the date/time clock annotation:

1. Press **SYSTEM**, **DISPLAY FUNCTIONS**, **DATE/TIME FUNCTIONS**.

This brings up the adjust date/time menu.

2. Select **SET: YEAR**. Notice that the date/time clock appears in the lower right-hand of the display. Also, notice the prompt in the active entry area. Use the knob to adjust the year.
3. Select **SET: MONTH**. Press **2** (or other numeric characters from 1 to 12), then press **x1** to terminate the entry. Notice that the month annotation is automatically translated to a three letter abbreviation of the month, in the date/time annotation.
4. Select **SET: DAY**. Use the **▲/▼** arrow keys to adjust the day.
5. In the same manner, you can adjust the hour and minutes of the date/time clock.

Note You can use the RPG knob, numeric entry keys with a terminator, or the / arrow key to enter any value. Any association with a particular key is for demonstration purposes only.

Using Security Features in the System **DISPLAY FUNCTIONS** Menu

The **CRT OFF** softkey turns the display OFF, resulting in a blank display. External displays driven by the network analyzer rear-panel EXTERNAL DISPLAY output continue to function. To turn the display ON again, press **RECALL MORE FACTORY PRESET**, or recall an Instrument State which was created with the display turned ON.

The **FREQUENCY OFF** softkey turns off frequency annotations display OFF. All stimulus functions operate normally except that the start, stop, center, and span display values are set to 0.000000000 GHz and the marker frequency value is blanked. The Time Domain stimulus display is not changed. **FACTORY PRESET** or **RECALL** of Instrument State stored without **FREQUENCY OFF** restores normal Frequency Domain displays.

Controls that Affect Input/Output

The following controls affect how the network analyzer communicates with external instruments:

GPIB Addresses

The GPIB address menu is identical to the main local menu and address assignments are made the same way. The following is a list of address assignments you can make using either of these menus. The factory default values are shown in parenthesis.

Note If you perform either of the following, you must turn the network analyzer OFF, then ON again:

- When you change the address of any instrument on the System Bus.
- When you replace an RF or LO source with a source having a different model number.

System operating problems can result if you do not follow the above precautions.

ADDRESS of 8510 (16)

SYSTEM BUS (17)

SOURCE #1 (19)

SOURCE #2 (31)

TEST SET (20)

RF SWITCH (31)

POWERMETER (31)

MORE

DISC (0)

PLOTTER: HP-IB (05)

PLOTTER: RS-232 PORT #1

PLOTTER: RS-232 PORT #2

PRINTER: HP-IB (01)

PRINTER: RS-232 PORT #1

PRINTER: RS-232 PORT #2

PASS-THRU (31)

To set the bus address of a device on the system bus, press **SYSTEM**, **HPIB ADDRESS**, then follow the steps below:

1. Check the hardware switch (usually located on the rear-panel of the instrument). Convert the binary switch setting to decimal format.
2. Select the corresponding network analyzer softkey for that instrument.
3. Set the decimal value using the knob, step, or numeric keys.
4. Terminate with the **↵** key.
5. Press **RECALL** **MORE** **FACTORY PRESET**.

GPIB Configure

The softkeys in this menu control system operation in response to a **PRES**; GPIB command (issued by a computer).

- Select **HP-IB USES USER PRESET** to use the **PRES**; command the same as the front-panel key **USER PRESET**.
- Select **HP-IB USES FACTORY PRESET** to use the **PRES**; command the same as the softkey **FACTORY PRESET** (under **RECALL** **MORE**).

Edit Multiple Source

The **EDIT MULT. SCR.** softkey accesses the menu that allows you to configure the system for the following:

- LO Sources
- External Mixers
- RF frequency multipliers that do not have a digital communications link (source module interconnect) with an RF source.
- Special modules that must be tested with an IF output frequency other than 20 MHz.

Power Leveling

Press **SYSTEM** **MORE** **POWER LEVELING** to enter the System Power Leveling Menu, shown in Figure 5-4. This function is part of the Hardware State and is not changed by power-up or preset or an instrument state recall.

SOURCE 1: INTERNAL

The RF source (source 1) levels its power using its internal leveling when this is selected.

SOURCE 1: EXT. LEVEL

When this is selected, the RF source requires an external leveling loop to complete its leveling loop. Refer to the individual source manual to find information on external leveling requirements.

SOURCE 1: MM MODULE

This setting should be used in millimeter wave systems where the source module interface cable is attached to the **SOURCE MODULE INTERFACE** connector on the RF source.

Controls that Affect I/O

POWER LEVELING MENU

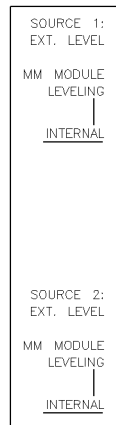

powlev

Figure 5-4. System Power Leveling Menu

Source 2 leveling requires the two following items:

- The LO source GPIB port must be connected to the network analyzer system bus.
- An LO source must be specified in the network analyzer's Multiple Source menu before you can change its power leveling type. Other LO source power and phaselock controls (LOCK TYPE) are located in the **SYSTEM** key menus. The Source 2 leveling functions are the same as those used for Source 1.

Controlling Multiple Sources

Many measurement systems require remote mixers, and therefore require an LO source. Such a system is shown in Figure 5-5. The network analyzer controls all aspects of RF and LO source frequencies. In setups that use multiple sources, the Multiple Source Menu allows the network analyzer to properly manage these frequencies.

Here is an example of a setup that requires multiple source mode. The system shown uses an LO source and 3rd harmonic mixers.

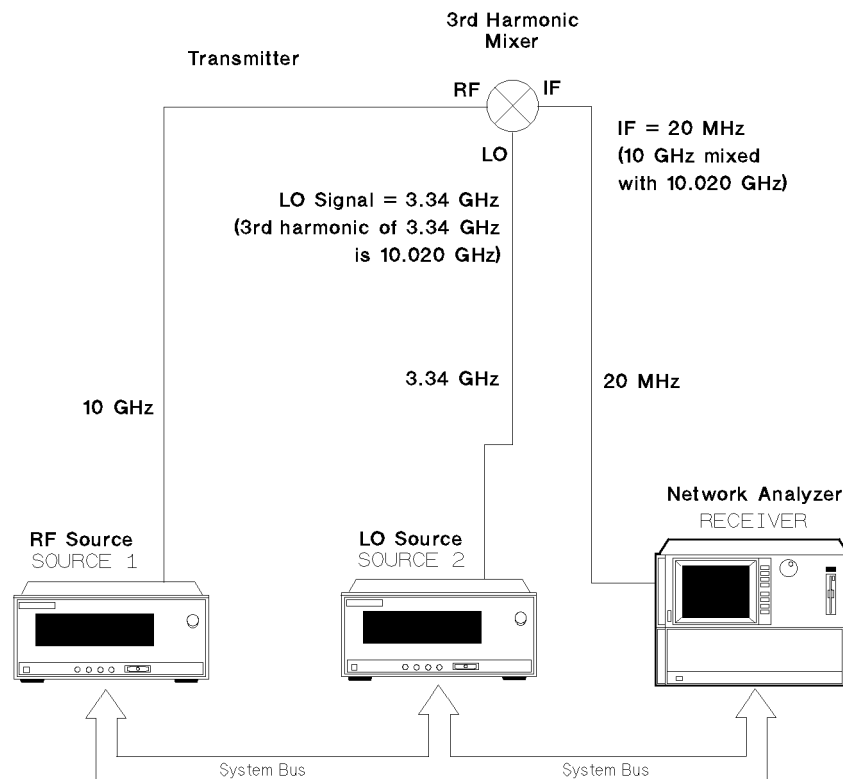

Figure 5-5. Actual LO Frequency Required by a Harmonic Mixer

This setup creates two management tasks for the network analyzer:

- The LO source must supply the appropriate LO signal to the mixer. The mixer uses the third harmonic of the LO signal. The network analyzer must compensate by setting the LO source frequency to be 1/3 of the needed frequency. The formula shown in Figure 5-7 would be appropriate for this situation.
- The mixer must produce a 20 MHz IF for the network analyzer. Therefore, the third harmonic of the LO frequency must be 20 MHz away from the RF frequency.

The Multiple Source Menu provides the special control for this and other types of setups.

Press **SYSTEM** **MORE** **EDIT MULT. SRC.** to display the Multiple Source Menu. It appears as shown in Figure 5-6.

Controlling Multiple Sources

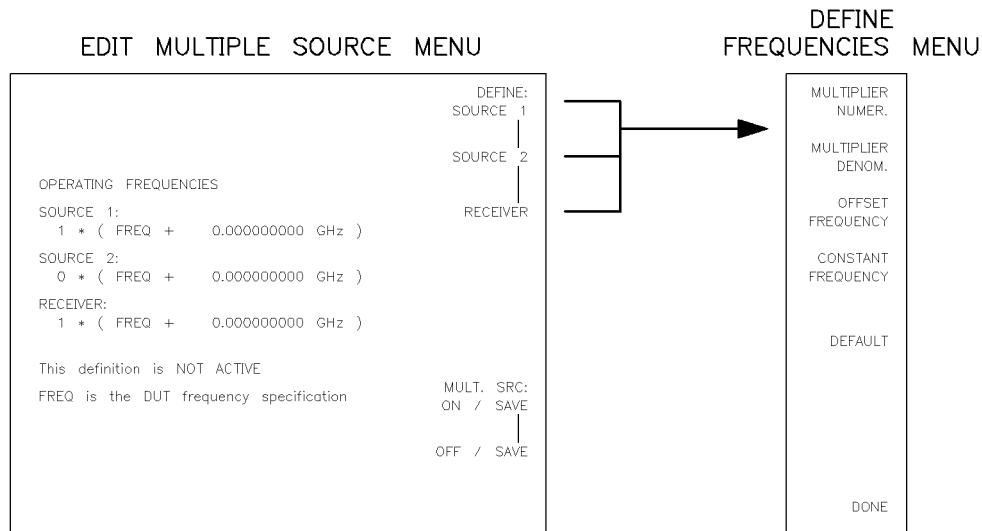

Figure 5-6. Edit Multiple Source Menu

There are three entries in the multiple source mode, labeled: SOURCE 1 (the RF source), SOURCE 2 (the LO source), and RECEIVER. Each of these entries contains a blank formula.

- SOURCE 1 the SOURCE 1 formula tells the network analyzer to adjust frequency commands sent to the RF source.
- SOURCE 2 the SOURCE 2 formula tells the network analyzer to adjust frequency commands sent to the LO source.
- RECEIVER the RECEIVER formula tunes the frequency converter to the frequency sent by the mixer.

Examples are provided later for each of these formulas.

Using the Multiple Source Menu

Given the test setup shown earlier, here is an example of how to use the Multiple Source Menu.

Look at the SOURCE 2 line. Like the other two lines, this one is accompanied by a formula. Refer to Figure 5-7 and Figure 5-5.

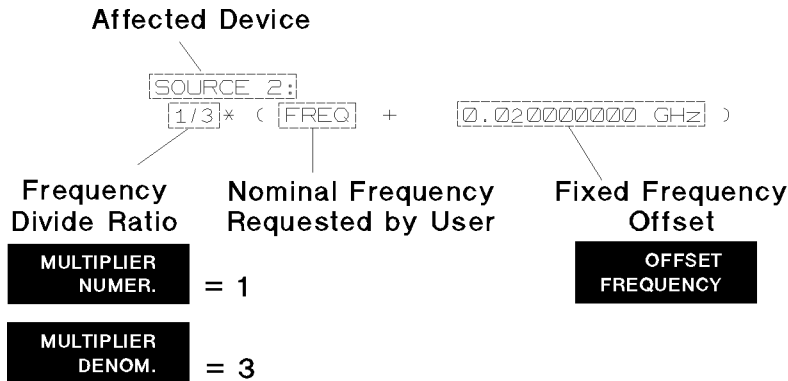

Figure 5-7. Source 2 Modified for Third Harmonic Mixer System

The term **FREQ** represents the original *RF* frequency requested by the user. First, the offset (20 MHz) is added to the original frequency value. Since 1/3 is entered as a multiplier, (**FREQ** + 20 GHz) is now divided by 3.

The functions in the Multiple Source Menu, shown in Figure 5-6, are explained below:

MULTIPLIER NUMER.	As shown in Figure 5-7, the frequency multiplier is entered as a fraction <i>x/y</i> . This softkey allows you to enter the numerator (<i>x</i>), which is 1 in almost all applications. Terminate this entry with [x1] .
MULTIPLIER DENOM.	This allows you to enter the denominator (<i>y</i>) for the frequency multiplier. In harmonic mixer setups, the denominator is always equal to the harmonic used by the mixer. In other words, if the mixer is a 10th harmonic type, use a denominator of 10. Terminate this entry with [x1] .
OFFSET FREQUENCY	This enters a fixed offset which is added to, or subtracted from, the FREQ frequency. (FREQ represents the stimulus (<i>RF</i> source) frequency entered by the user.) In most setups the offset you enter becomes the <i>IF</i> frequency. To enter a positive offset, simply enter the desired offset value. Terminate this entry with an appropriate units key. To enter a negative offset, press [+/-] , enter the value, then press the appropriate units terminator key.
CONSTANT FREQUENCY	When used with SOURCE 1 or SOURCE 2 , sets the source to one fixed frequency. When used with RECEIVER , it tunes the frequency converter to measure that particular frequency. Terminate this entry with an appropriate units key.
DEFAULT	Returns the Multiple Source menu to factory default settings.
DONE	Press after defining the SOURCE 1 , SOURCE 2 or RECEIVER formula.

How to Enter the Example Configuration

Still following the original example setup, here are the steps required to configure the Multiple Source menu for the *LO* source and 3rd harmonic mixer.

1. First, configure the **SOURCE 2** formula for a 3rd harmonic mixer, with 20 MHz offset:
 - a. Press **DEFINE: SOURCE 2**.

Controlling Multiple Sources

2. The multiplier requires two values, the numerator, and denominator. For the example above, you would press:
 - b. `MULTIPLIER NUMER.` 1 `(x1)`
 - c. `MULTIPLIER DENOM.` 3 `(x1)`
 - d. `OFFSET FREQUENCY` 20 `(M/μ)`
 - e. `DONE` (indicates you are finished defining the Source 2 formula)
3. Next, configure the receiver formula to measure the 20 MHz IF produced by the mixer. Press the following keys:
 - a. `DEFINE: RECEIVER`
 - b. `CONSTANT FREQUENCY` 20 `(M/μ)`
 - c. `DONE`

Now save the configuration. Before leaving the multiple source menus, you must press either `MULT. SRC: OFF/SAVE` or `MULT. SRC: ON/SAVE`. If not, all definition changes are lost. These softkeys turn the function on or off and save the equation definitions in the Hardware State. Note that changes can be made and saved with the mode off (using `MULT. SRC: OFF/SAVE`). This means that at power-up the equations are defined but not active.

Figure 5-8 shows how the multiple source menu looks after you perform the above steps, and press `MULT. SRC: ON/SAVE`.

Note

Do not be concerned if you see the error message: `CHANGING STEP TYPE TO NORMAL STEP`. This message occurs if the network analyzer was in the quick phase lock mode. The network analyzer cannot use quick phase lock mode when multiple sources are in use, and selects normal phase lock mode instead.

```
OPERATING FREQUENCIES
SOURCE 1:
  1 * ( FREQ + 0.000000000 GHz )
SOURCE 2:
  1/3 * ( FREQ + 0.020000000 GHz )
RECEIVER:
  0.020000000 GHz

This definition is ACTIVE

FREQ is the DUT frequency specification
```

Figure 5-8.
Finished Multi-Source Configuration, LO Source and 3rd Harmonic Mixers

Note that the example setup in Figure 5-5 requires NO changes to the default SOURCE 1 configuration.

5-14 Using System Functions

Millimeter Wave Mixers

The SOURCE 2 setup would only change slightly for millimeter wave systems (that use mixers with large harmonic values). For example, Q band mixers use 10th harmonic mixers. To use these mixer types, you would simply enter a 10 as the multiplier denominator. The numerator and offset remain the same.

Uses for the SOURCE 1 and RECEIVER Formulas

As implied above, the three formulas in the Edit Multiple Source menu (SOURCE 1, SOURCE 2, and RECEIVER) compensate for frequency translation that is occurring somewhere in the system.

SOURCE 1 Formula Use

The SOURCE 1 formula could compensate for any frequency translation occurring in the RF portion of the system. An example would be a frequency multiplier *that cannot communicate digitally with the RF source*. Agilent multipliers and most RF sources have an interconnect bus that allows them to communicate directly. When using these devices you *do not* need to change the SOURCE 1 formula from the default settings. However, if you have a source or multiplier that does *not* have the interconnect, then change the SOURCE 1 formula as needed:

For example, for a 3x multiplier you would enter 1/3 as the multiplier (and no offset). Assume you are using this type of setup, and you request an RF frequency of 45 GHz. The network analyzer divides that value by 3 and programs the RF source for the new value (15 GHz). The RF source outputs 15 GHz, which is then multiplied (by 3) by the RF multiplier. The multiplier then outputs the desired 45 GHz signal.

Receiver Formula Use

All the examples above assume that a 20 MHz IF frequency is available from the frequency converter. These examples are very useful if you are testing discrete devices. However, some users may need to test modules which contain mixers, and which may not produce a 20 MHz IF output.

Figure 5-9 shows an example setup.

Controlling Multiple Sources

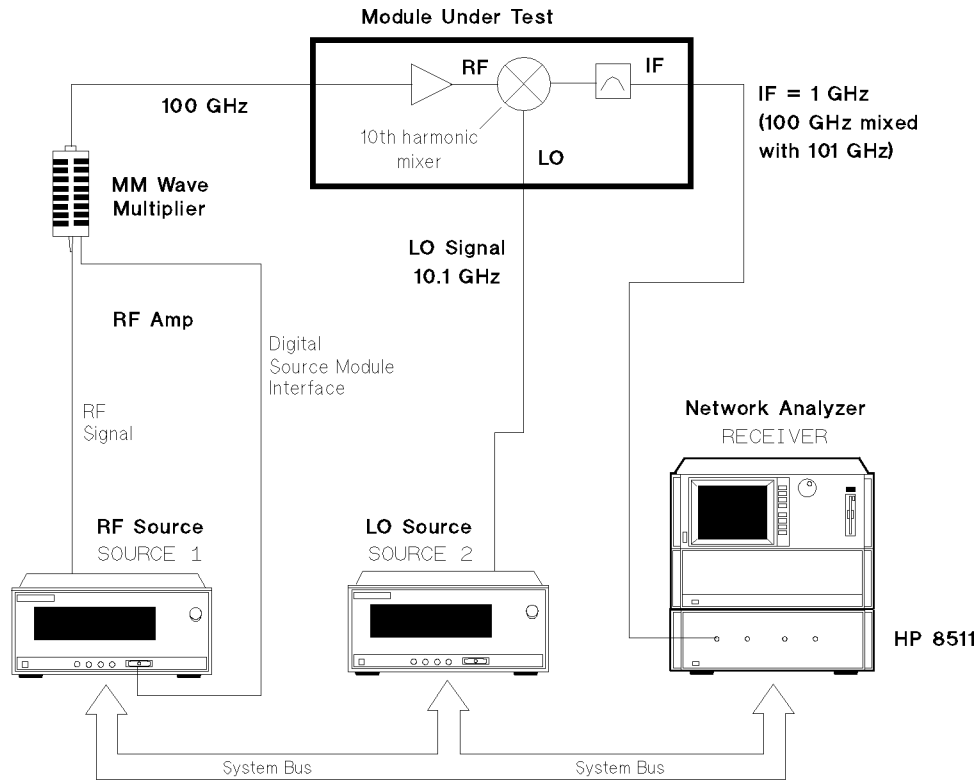

Figure 5-9. Module Testing Example

Note that the Module Under Test contains a 10th harmonic mixer. Also, the module only produces a 1 GHz IF signal. In this example you must modify the SOURCE 2 and RECEIVER formulas as follows:

```
SOURCE 2
  1/10 * ( FREQ + 1.000000000 GHz )
```

```
RECEIVER
  1.000000000 GHz
```

(The RECEIVER is set to a CONSTANT FREQUENCY of 1 GHz.)

Why are these settings used?. Here are the objectives of this measurement setup:

- The final LO frequency must mix with a 100 GHz RF signal to produce a 1 GHz IF. Therefore the final LO frequency must equal 99 or 101 GHz. For the sake of this example, 101 GHz is used.
- The LO frequency output by the LO source must be 1/10th of the required LO frequency. This is because the 10th harmonic mixers essentially multiplies the LO frequency by 10 (by picking the 10th harmonic).
- The setup must allow the network analyzer/frequency converter combination to measure the 1 GHz IF signal.

These design objectives are met as follows:

- The formula for SOURCE 2 must be:

$$1/10 * (\text{RF FREQ} + 1.000000000 \text{ GHz})$$

This yields:

$$1/10 * (100 \text{ GHz} + 1 \text{ GHz})$$

$$= 1/10 * 101 \text{ GHz}$$

$$= 10.1 \text{ GHz}$$

When the mixer picks the 10th harmonic, it is at 101 GHz. Therefore, the IF becomes 1 GHz.

- The network analyzer must tune the 8511 frequency converter to measure 1 GHz. Setting RECEIVER to a constant frequency of 1 GHz does this.

Figure 5-10 shows how the multiple source menu appears after these changes are made.

```
OPERATING FREQUENCIES
SOURCE 1:
  1 * ( FREQ + 0.000000000 GHz )
SOURCE 2:
  1/10 * ( FREQ + 1.000000000 GHz )
RECEIVER:
  1.000000000 GHz

This definition is ACTIVE
FREQ is the DUT frequency specification
```

Figure 5-10. Finished Multiple Source Configuration for Hypothetical Module

Service Functions

Service Functions

The Service Functions menu contains several functions that are useful to you as an operator. Some keys on this menu however, are more appropriate for service personnel and are discussed in the *Agilent 8510C On-Site Service Manual*.

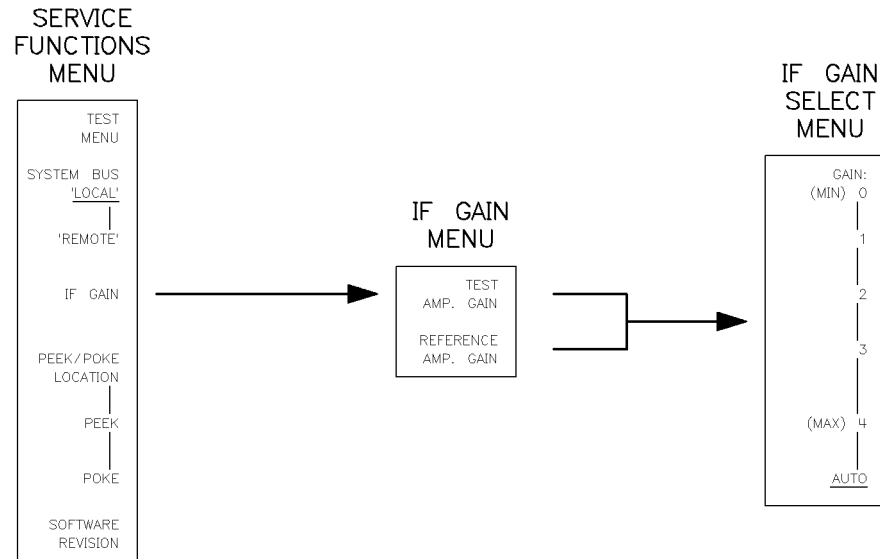

Figure 5-11. Service Functions Menu

To view the service functions menu, press **(SYSTEM) MORE SERVICE FUNCTIONS**.

Test Menu

Access the Test menu by pressing **(SYSTEM) MORE SERVICE FUNCTIONS TEST MENU**. Selecting **TEST MENU** disables the GPIB interface. This menu gives access to self-test menu items.

To return to normal operation, enter 15 then **(= MARKER)**, or cycle line power, or press the TEST button. Operation of selections from the Test menu are described as part of the service procedures in the *Agilent 8510C On-Site Service Manual*.

Note To exit the Test menu, enter 15 with the numeric keypad, then press **(=0)**. The instrument state is reset to factory preset.

The following list of options are available in the test menu:

Table 5-1. Test Menu

MAIN SERVICE FUNCTIONS MENU	
LOOPING SELF TESTS	SYSTEM COMMANDS
1 A5 PROCESSOR EPROM	15 RUN MAIN PROGRAM
2 A5 PROCESSOR RAM	16 MEMORY OPERATIONS
3 A7 DATA BUS	17 RERUN SELF TEST
4 A4 (A14) DISPLAY PROCESSOR	18 REPEAT TEST LOOP
5 A4 (A14) DISPLAY RAM	DISC COMMANDS
6 A7 TIMER/CLOCK/RS-232	19 LOAD PROGRAM DISC
7 A7 PUBLIC HPIB	20 RECORD PROGRAM DISC
8 A7 SYSTEM BUS	21 INITIALIZE DISC
9 INTERRUPT SYSTEM	SERVICE COMMANDS
10 A5 MULTIPLIER	22 RUN SERVICE PROGRAM
11 A7 DISC CONTROLLER	23 DIAGNOSE A FAILURE
12 A6 NON-VOLATILE MEMORY	
13 IF DETECTOR DATA	
14 KEYBOARD	
ENTER SELECTION, THEN PRESS =MARKER	

Disc Commands

- 19 LOAD PROGRAM DISC Use this selection to load or reload the operating system. Slide the operating disc into the disc drive. Press **1 9 =MARKER**. In about one minute, the operating system should be loaded and running.
- 20 RECORD PROGRAM DISC Use this selection to record a backup copy of the operating system on an initialized blank disc. Slide the initialized disc into the disc drive. Press **2 0 =MARKER**.
- 21 INITIALIZE DISC Use this selection to initialize a disc prior to recording the operating system on it. You can use a disc that has been recorded on, but it should be double-sided and of good quality. Slide the disc into the disc drive. Press **2 1 =MARKER**.

System Bus Softkeys

Use the **SYSTEM BUS 'LOCAL'** softkey to suspend all activity on the System Bus and enter the *hold* mode. Front panel control of instruments connected to the System Bus is enabled to allow you to change instrument functions not controllable from the network analyzer.

Selecting **SYSTEM BUS 'LOCAL'** also allows an external controller to communicate directly with any “appliance” or instrument on the System Bus via the System Bus Address.

Any *pass-thru* command to any “appliance” or instrument on the System Bus causes an automatic System Bus ‘LOCAL’.

Selecting **SYSTEM BUS 'REMOTE'** returns control of instruments on the System Bus to the network analyzer. Source functions controlled by the network analyzer are returned to the state represented by the current network analyzer Instrument State (for example: ramp/step/single point, frequency range, sweep time, source power, and power slope). Other source functions set from its front-panel are not changed. The test set is interrogated and parameter definitions are established (see **REDEFINE PARAMETER**). Raw data arrays are zeroed and the displayed trace is updated by the next group of sweeps.

Service Functions

Addressing the network analyzer GPIB after pass-thru to any System Bus Address (except address 31) causes an automatic System Bus 'Remote'.

IF Gain

The IF Gain menus allow you to select either autoranging or fixed IF gain control for the 8510C input signal paths. Remember, the IF section of the network analyzer:

- Downconverts the 20 MHz input signals to a lower frequency, so the signal is easier to manipulate and sample.
- Changes the amount of IF gain so the detectors and A/D converter operate with optimum accuracy (refer to Figure 5-12).
- Selects the input ratio (b1/a1 for example).

Normally the network analyzer uses automatic gain control. In this mode, the network analyzer automatically adjusts IF gain for a high signal level (around -15 dBm) at the detectors and A/D converter. This allows the detectors and A/D converter to operate with optimum accuracy. The default (automatic) mode is appropriate for almost all measurement setups.

Why Use Manual Control

You should use manual IF gain control if any of the following applies to your measurement:

- There are large power changes between adjacent data points (greater than 24 dB between points).
- The "IF OVERLOAD" message keeps appearing, even though RF Power to the network analyzer inputs is less than -10 dBm.

Why the problem occurs. When the network analyzer measures a data point, automatic IF gain control detects the power at the input. Assume (for example) that this is a very low power level. The gain control increases IF gain to amplify the signal. This allows the synchronous detectors and A/D converter (shown in Figure 5-12) to operate in their most accurate range. Now assume the network analyzer measures the next data point, and the power level is much higher. The IF gain stages are still set for the previously-measured low power level. When the large signal arrives, it is amplified greatly and often overdrives the detectors. The error message "IF OVERLOAD" appears when this occurs.

Figure 5-13 shows a block diagram of the IF gain stage.

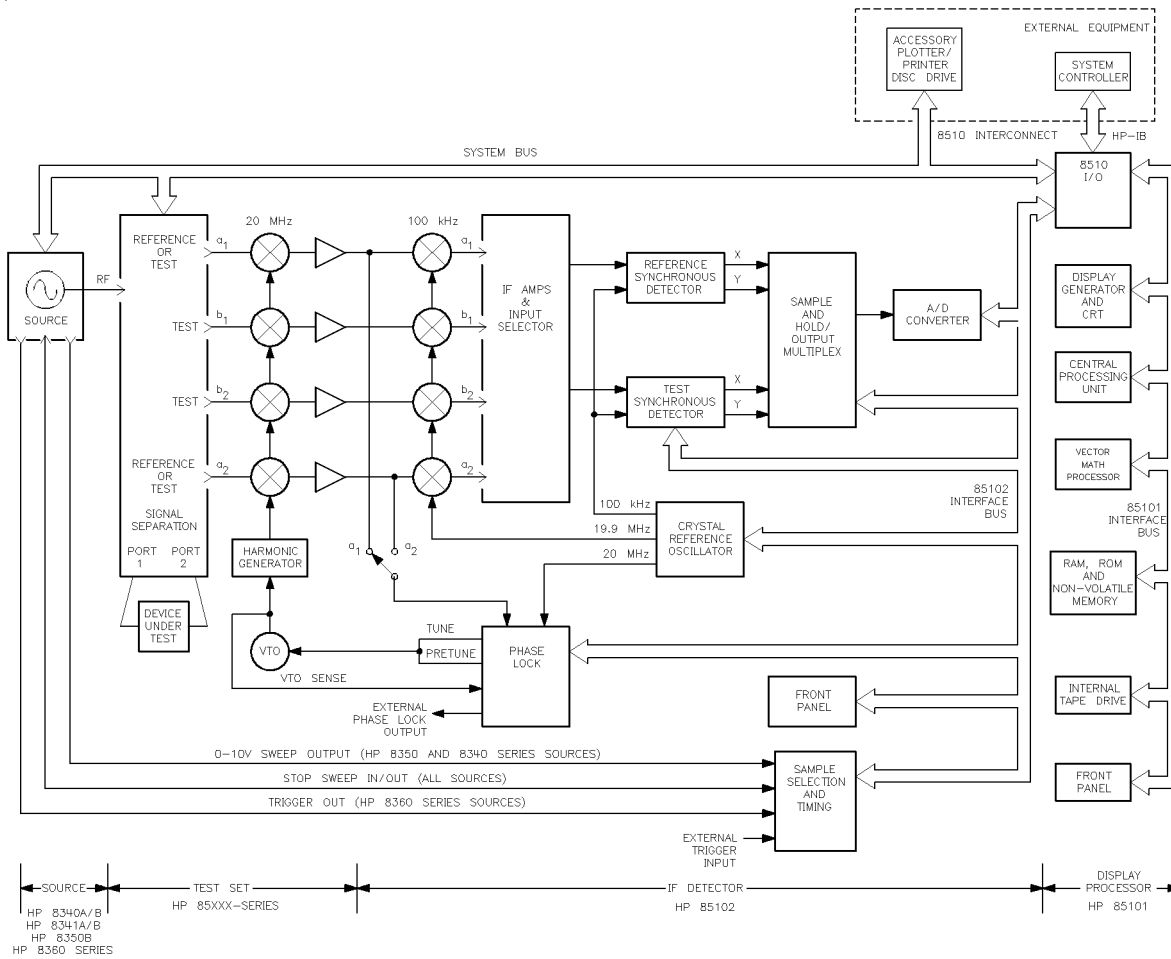

Figure 5-12. Simplified Block Diagram of the Agilent 8510C Network Analyzer

Note the block in Figure 5-12 titled “IF AMPS & INPUT SELECTOR.” It is this section that we evaluate more closely in Figure 5-13.

Service Functions

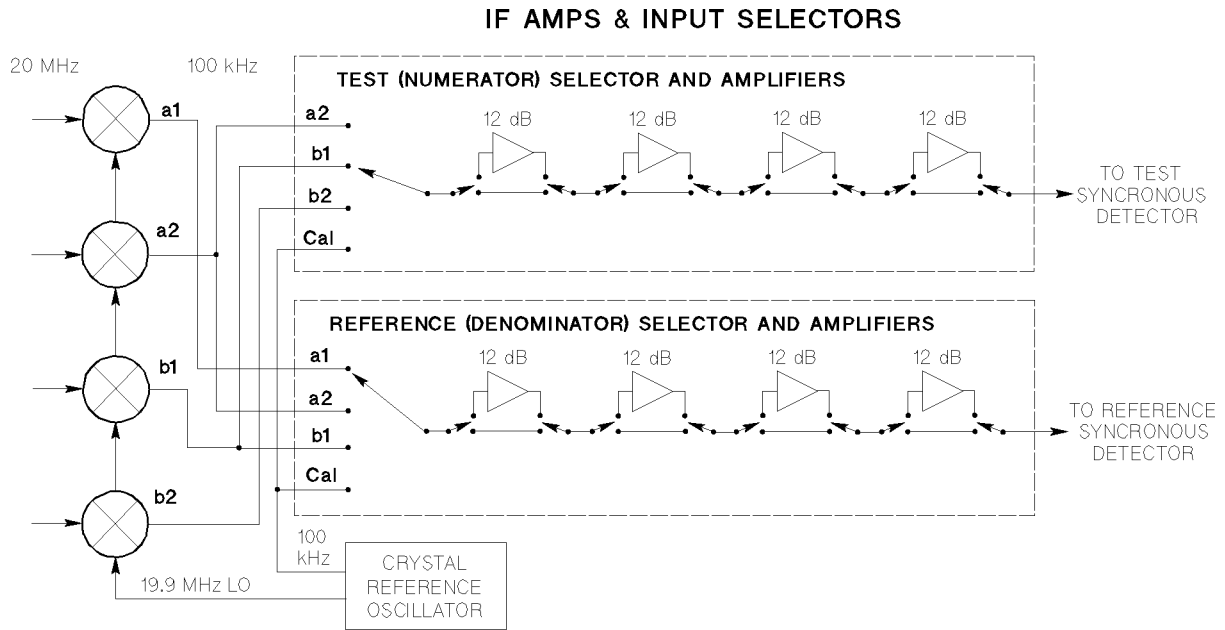

Figure 5-13. Gain Stages in the IF section

Notice that, in Figure 5-12, the 100 kHz mixers are shown as having only a single output each. This is not really true. Figure 5-13 shows a closer representation of the actual circuitry. The different signals (a1, a2, b1, and b2) are split off and routed to *input selectors*. When you select a specific parameter, a ratio such as $a1/b1$ is selected. The network analyzer automatically selects the correct positions on the input selector to send the b1 signal to the test channel, and a1 to the reference channel.

The signals then go to a series of 12 dB amplifiers. In automatic IF gain mode, the network analyzer controls these amplifiers. These amplifiers can also be controlled manually with the softkeys in the IF Gain Select Menu.

How to Use Manual IF Gain Controls Properly

You can solve the IF OVERLOAD problem by using fixed IF gain, and setting it as necessary for the *higher power level*.

Press **(SYSTEM) MORE SERVICE FUNCTIONS IF GAIN**. Then select gain control for either the test or reference path with **TEST AMP. GAIN** or **REFERENCE AMP. GAIN**.

The fixed gain control softkeys are now displayed:

GAIN: (MIN) 0	Turns all four amplifiers OFF for that test or reference path (0 dB gain).
GAIN: 1	Turns one amplifier ON for that test or reference path (12 dB gain).
GAIN: 2	Turns two amplifiers ON for that test or reference path (24 dB gain).
GAIN: 3	Turns three amplifiers ON for that test or reference path (36 dB gain).
GAIN: (MAX) 4	Turns all four amplifiers ON for that test or reference path (48 dB gain).
AUTO	The receiver automatically adjusts IF gain for a high signal level at the detectors and A/D converter. At this level, the A/D converter and detectors can operate with optimum accuracy.

No matter which gain setting you choose, the network analyzer adjusts *displayed* power levels automatically.

Peek and Poke

Caution	The POKE function is <i>NOT</i> for casual usage. Only qualified service personnel should use this softkey. <i>Using POKE is a GUARANTEED way to harm the network analyzer's operating system, unless it is done under the supervision of a qualified Agilent service representative.</i> Misusing POKE can cause all kinds of operating and measurement problems. Some problems may corrupt measurement data without the operator being aware of it.
	Service personnel are aware that valid POKEs change firmware versions from one version to the next.

If you have already “poked” some values, you can restore the integrity of the network analyzer by reloading the 8510C operating system. To do this, insert the operating system disc and press:

SYSTEM **MORE SERVICE FUNCTIONS** **TEST MENU** 19 **=MARKER**

Purpose of Peek and Poke

It is possible to examine memory locations in the network analyzer using the **PEEK** softkey, and change their contents using **POKE**. These functions are for service personnel only.

The **SOFTWARE REVISION** softkey displays the date and revision code of the operating system firmware. Use this key to determine the firmware revision and to help in communications about the firmware.

COPY

Printing and Plotting

Chapter Contents

- Installation Considerations
- RS-232 Print/Plot Buffers
- Adding Custom Annotations to the Display
- Using a Printer
- Printing and the 8510C Configuration
- Using a Laser Printer
 - Using the Standard Configuration
 - Using the High Speed Configuration
- Using an HP DeskJet, DeskJet Plus, or DeskJet 500 or 550 Series Printer
- Using an HP QuietJet, QuietJet Plus, PaintJet or PaintJet XL Printer
- Using an HP ThinkJet Printer
- Using Non-HP Printers
- Printing
 - Printing One Snapshot per Page
 - Printing Two Snapshots per Page
 - Printing Tabular Measurement Data (as text)
 - Printing Instrument Settings and System Configuration (as text)
- Using a Plotter
 - Installing a Plotter
 - Plotting Options
- Plotting

Installation Considerations

The following topics explain the printing and plotting capabilities of the 8510C.

Supported Interfaces

The **COPY** key (in the AUXILIARY MENUS block) provides the means to control output to a GPIB or RS-232 plotter or printer.

Note

In order to use currently available printers, a GPIB to parallel port adapter is needed. Adapters, such as MicroPlot 50A, are available from Intelligent Interfaces. For more information, consult their web site at: <http://www.intelligentinterfaces.com>.

Connecting a GPIB Printer or Plotter

To use a GPIB printer or plotter, connected it to the system bus. *GPIB outputs are not buffered.* After sending the print or plot command, you must wait for the output to finish before pressing any other keys. Pressing any key during the output aborts the process and can cause a timing error. If you need to abort the process, use the **ABORT PRINT/PLOT** softkey, located in the Copy function main menu.

Connecting an RS-232 Printer or Plotter

The 8510C has two serial interfaces. You can select either of these interfaces for printing or plotting. In addition, you can assign one of the ports to a printer, and the other to a plotter.

An RS-232 plotter/printer normally accepts data and does not “answer” or “acknowledge” that data has been received and, as such, the network analyzer may be unable to determine if a plotter/printer is connected to the RS-232 port selected. A message saying that the plot is complete may result even if no plotter/printer is connected.

Selecting the GPIB (System Bus) or RS-232 Ports

Softkeys in the **LOCAL** menu allow you to:

- Select GPIB (system bus), RS-232 Port #1, or RS-232 Port #2 for serial printers or plotters.
- Set the GPIB address of a GPIB printer or plotter. Information on address selection is provided in the SYSTEM chapter.

RS-232 Print/Plot Buffers

Both RS-232 ports have a built-in print/plot buffer. The network analyzer can dump most (or all) of the data into the buffer during the print or plot. Once all of the data has made it into the buffer, the buffer continues to send the data to the printer or plotter, and the network analyzer can make measurements again.

The buffer in RS-232 Port #1 is much larger than the one in RS-232 PORT #2 (400 kBytes and 100 kBytes respectively). Therefore, it is preferable to connect your printer or plotter to Port #1. This becomes more important when making high resolution printouts at 150 or 300 DPI. (These high resolutions are available if you use an HP DeskJet or laser printer.) High resolution printouts contain a large amount of data, which takes longer to send to the printer. The larger buffer in Port #1 holds more data, reducing the time it takes to resume measurements. Print resolution is explained fully in the printer setup section.

The system bus does not supply a print/plot buffer. Because of this, measurements are suspended until the print or plot is completely finished.

Adding Custom Annotations to the Screen

You can add your own text annotations to the screen before printing or plotting. To do this:

1. Press **SYSTEM** **DISPLAY FUNCTIONS** **TITLE**. A “label maker” menu appears.
2. Use the front panel knob to place the selection cursor under the first desired letter or number. Press **SELECT LETTER**.
3. Repeat this step for each desired character. Press **SPACE** to insert a space, and **BACKSPACE** to back up if you make a mistake. **ERASE TITLE** removes the title from the screen.
4. Press **TITLE DONE** when you are finished entering the title.

Printer Setup

Using a Printer

This section explains:

- How to install RS-232 or GPIB printers.
- How to configure the printer and the 8510C.
- How to Print

Printing Features

The printing feature allows you to:

- Print an exact copy of the display (a “snapshot”).
- Print measurement data in table form.
- Print instrument settings and system configuration.
- Print in Color, Monochrome, Portrait, or Landscape mode.
- Print one snapshot (measurement display) per page.
- Print two snapshots per page.

What Is Printed?

The displayed measurement is printed or plotted exactly as displayed on the screen. The softkey menus do not appear on prints/plots unless you select them using a GPIB command. The marker list and real-time clock are printed (if they are active), unless softkey menus are being printed.

Installing a Printer

Installation is described in the *Agilent 8510C On-Site Service Manual*.

Selecting the Output Port

Select the appropriate output port for your printer as follows:

1. Turn the network analyzer ON.
2. If using a serial printer: Press **LOCAL** **MORE** **PRINTER: RS-232 PORT #1** or **PRINTER: RS-232 PORT #2**, depending on which serial port you used.
3. If using a GPIB printer: Press **LOCAL** **MORE** **PRINTER: HP-IB**. The message **PRINTER HP-IB ADDRESS 1** appears on the screen.

Printer and the 8510C Configuration

The next step is to make appropriate switch settings on the printer, as explained in following pages. Also, the 8510C must be configured so it controls your printer properly. This is done with the Define Print menus, located under the **COPY** key. Refer to Figure 6-1.

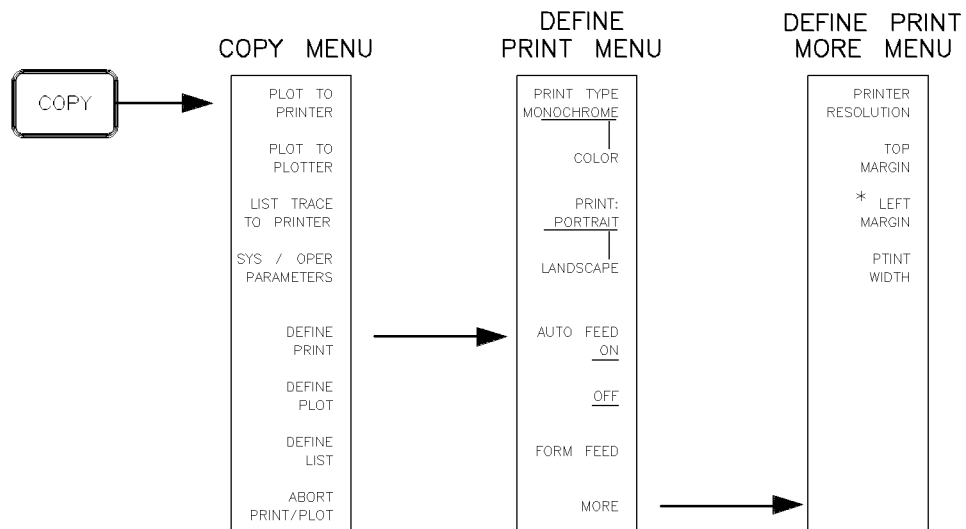

* The softkey "LEFT MARGIN" becomes "RIGHT MARGIN" when the print orientation is set to "LANDSCAPE". The programming code stays the same.

prinmen

Figure 6-1. Define Print Menu

The required settings are dependent on the type of printer you use. The following pages explain how to set up:

- HP-Compatible Laser Printers
- HP DeskJet, DeskJet Plus, or DeskJet 500 or 550 Series Printers
- HP QuietJet or QuietJet Plus Printers
- HP PaintJet or PaintJet XL Printers
- HP ThinkJet Printers
- Non-HP Printers

Using a Laser Printer

Connect the printer as explained in the installation chapter of the *Agilent 8510C On-Site Service Manual*.

Configuring the Laser Printer

There are two ways to configure a laser printer.

Standard This configuration requires no extra equipment and provides normal laser printer print speeds. Customers have asked for faster laser print-outs than the standard setup provides (it takes about 7 minutes to print one page at 300 DPI). This speed problem is caused by the laser printer, not with the 8510C. However, there is a clever way to get around the problem and speed printing up significantly. So why even talk about the “standard” (slow) method? Answer: Because the high speed method requires a special printer cartridge that you may not have.

High Speed The high speed configuration requires a special plug in cartridge for the printer. With this cartridge, a simple measurement display prints in about 12 seconds. A *very* complex print takes about 2 minutes 20 seconds. Most prints are completed in 1 minute or less.

Using the Standard Configuration

Turn the laser printer ON. Refer to the laser printer’s operating manual.

Select SERIAL input/output (I/O).

Use the factory default RS-232 settings for the printer:

Baud Rate 9,600
Robust Xon ON
DTR Polarity HI

These settings never have to be entered again.

Using Other Laser Printer Settings

1. If using metric paper sizes, refer to the printer manual for setup instructions.
2. Make sure paper is loaded.

Configuring the Network Analyzer

Selecting Printer Resolution

The 8510C allows you to select any print resolution from 1 to 1,200 DPI. Laser printers typically use 75, 100, 150, 300, and 600 dots per inch (DPI). To choose a specific resolution:

1. Press **COPY** **DEFINE PRINT** **MORE** **PRINTER RESOLUTION**.
2. Enter the desired value using the keypad, and press **x1**.

Note: Higher resolutions take longer to print.

For instructions on making actual printouts, refer to “Printing” towards the end of this chapter.

Using the High Speed Configuration

As mentioned above, you need a special cartridge called the “Plotter in a Cartridge” from Pacific Data Products. This device programs the laser printer so it understands plotter commands (HP-GL). The cartridge essentially turns the laser printer into a plotter. The “laser plotter” accepts HP-GL commands and “draws” the picture in its own memory. The printer then produces a page based on the “drawing” in its memory.

Why is it faster?

In *normal* laser printer operation, the analyzer must send pixel data for the *entire page*—even if the displayed measurement is very simple. A whole page of pixels at 300 DPI requires a little over 1 megabyte of data. It takes a long time to transfer this much data over the serial bus. With HP-GL emulation, printing is faster for two reasons: 1. There is far less data to transfer since only HP-GL commands must be sent over the serial bus. 2. The laser printer must only change memory locations that equate to black pixels. The majority of memory locations (those that represent white pixels) do not need to be accessed. This saves even more time.

My printer has built-in HP-GL.

Do I still need the cartridge?

Yes. To use the built-in HP-GL emulation mode, laser printers *usually* require the computer or instrument to send a special “escape sequence” code. The code turns HP-GL mode ON. Such printers usually do not allow you to turn HP-GL mode ON from the front panel. At this time, the 8510C cannot send this special code, so you must use a special cartridge to use HP-GL mode.

Ordering the Cartridge

There are two versions of Plotter in a Cartridge:

Standard	For use with the HP LaserJet Series II.
“Personal Edition” (P.E.)	For use with the HP LaserJet IIP, IID, III, and IIID.

You can order either of these cartridges from many computer suppliers. We found them for about half suggested retail price at:

DH Systems: 1940 Cotner Ave,
 Los Angeles, CA 90025
 (800)-747-4755
 Attention: Sales Department

The part number to order from DH Systems is:

Standard	DH 701-PCRT
Personal Edition	DH 702-PCRT-P

Printer Setup

If you want to contact the manufacturer of the cartridge, call or write:

Pacific Data Products
9125 Rehco Road, San Diego, CA. 92121
Phone: (619) 552-0880
Fax: (619) 552-0889

Having Enough Printer Memory

The plotter in a Cartridge requires 1.5 Mbytes of printer memory in order to operate.

Setting the Printer Up

1. Turn the laser printer ON. Refer to the laser printer's operating manual to perform the following.
2. Select SERIAL input/output (I/O).
3. Use the factory default RS-232 settings for the printer:

Baud Rate 9,600
Robust Xon ON
DTR Polarity HI

Using Other Laser Printer Settings

1. If using metric paper sizes, refer to the printer manual for setup instructions.
2. Turn the printer OFF.
3. Install the "Plotter in a Cartridge." If your printer has two cartridge slots, make sure you use the left slot.
4. Turn the printer ON.
5. Make sure paper is loaded.

Configuring the Network Analyzer

The following instructions look unusual because you are telling the 8510C to *plot*. Remember, the laser printer looks just like a plotter to the 8510C.

1. Determine which 8510C RS-232 port has the printer connected to it. (Agilent recommends RS-232 Port #1 because it has a larger printer buffer than RS-232 Port #2.)
2. Press **LOCAL** **MORE** and **PLOTTER: RS-232 PORT #1** or **PLOTTER: RS-232 PORT #2**. Be sure you have chosen the appropriate port under "PLOTTER:" on the softkey menu.
3. To "print," press:

COPY **PLOT TO PLOTTER** **PLOT: ALL**

For other "printing" options, refer to the section on *PLOTTING* later in this chapter. Remember, the network analyzer thinks the laser printer is a plotter.

Note

You may want to photocopy the following notice and tape it near your 8510C:

TO PRINT:

1. Make sure the "Plotter in a Cartridge" is installed. Turn the printer OFF when installing the cartridge! (Remember, it goes in the left cartridge slot.)
2. On the 8510C, press **COPY**, **PLOT TO PLOTTER**, **PLOT:ALL** (trust us on this).

This could save the "occasional" user a great deal of confusion when they try to make print outs.

Switching Between Real Plotters and HP-GL-emulating Laser Printers

To switch between a laser printer (acting like a plotter) and a real plotter, you must select the port to which the desired device is connected.

Press **LOCAL MORE**, then press one of the following softkeys:

- | | |
|--------------------------------|---|
| PLOTTER: HP-IB | Press this to select a real plotter connected to the GPIB bus. |
| PLOTTER: RS-232 PORT #1 | Press this to select a real plotter or "laser plotter" connected to RS-232 Port #1. |
| PLOTTER: RS-232 PORT #2 | Press this to select a real plotter or "laser plotter" connected to RS-232 Port #2. |

Printer Setup

Using an HP DeskJet, DeskJet Plus, or DeskJet 500 or 550 Series Printer

Choose the serial (RS-232) or GPIB setup, depending on how your printer is equipped:

Using Serial Setup

Connect the printer as explained in the 8510C On-Site Service Manual. The 8510C does not support the Centronics interface.

Setting the Serial DIP Switch

Make sure all DIP switches (mounted in the lower-front portion of the printer) are all in the down position. These recommended switch settings assume you are using 8.5 by 11 inch paper. If using metric paper sizes, refer to the printer manual for proper DIP switch settings.

Preparing the Printer for Use

Load the paper, then turn the printer ON.

Configuring the Network Analyzer

Selecting Printer Resolution

The 8510C allows you to select any print resolution from 1 to 1200 DPI. HP DeskJet printers typically use 75, 100, 150, and 300 dots per inch (DPI). To choose a specific resolution:

1. Press **(COPY) DEFINE PRINT MORE PRINTER RESOLUTION**.
2. Enter the desired value using the keypad, and press **(x1)**.

Note: Higher resolutions take longer to print.

Now refer to “Printing” near the end of this chapter for instructions on making actual printouts.

Using the HP DeskJet 500C or 550C

Additional Steps Required

The color capabilities of the HP DeskJet 500C or 550C are supported. You can use this printer to make printouts by performing the following steps:

1. Make sure the network analyzer is set to color mode.
2. If needed, press the following keys to set the network analyzer:

(COPY) DEFINE PRINT PRINT TYPE COLOR

Using an HP QuietJet, QuietJet Plus, PaintJet, or PaintJet XL Printer

Choose the serial (RS-232) or GPIB setup, depending on how your printer is equipped:

Using Serial Setup

Refer to Chapter 9, “Installation,” in the *Agilent 8510C On-Site Service Manual*, for information about connecting the printer.

Setting the Serial DIP Switch

Make sure all DIP switches are positioned as shown in Figure 6-2. If necessary, refer to the printer’s user’s guide for switch location. These recommended switch settings assume you are using 8.5 by 11 inch paper. If you are using Metric paper sizes, refer to the printer manual for the appropriate switch settings.

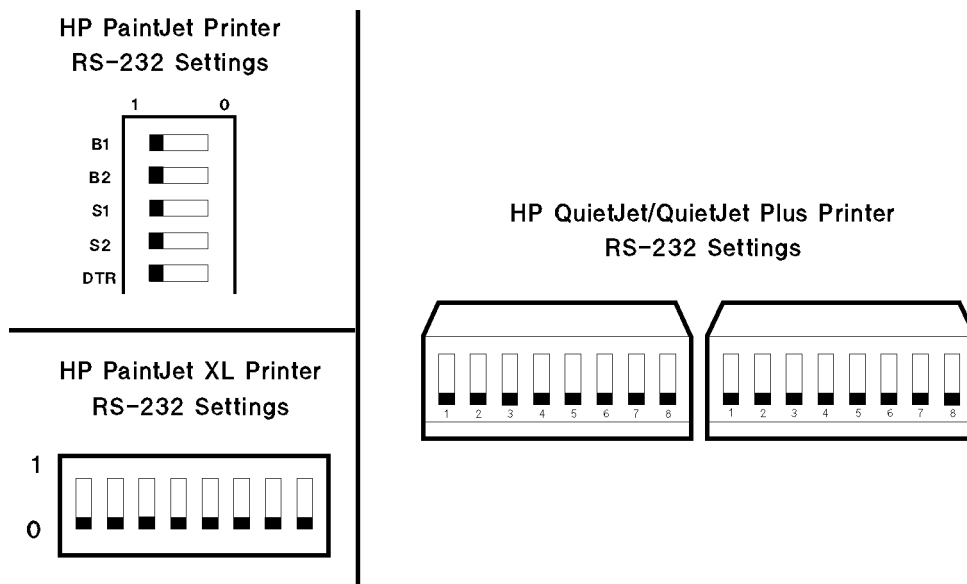

Figure 6-2. HP QuietJet and PaintJet (Family) Printer Serial Switch Settings

Printer Setup

Setting Up GPIB

Connect the printer as explained in the service manual.

Setting the GPIB Address DIP Switch

Set the printer DIP switches as shown in Figure 6-3. The HP 8510C uses address 01 as the default GPIB address for printers. Figure 6-3 shows proper switch settings (with the GPIB address set to 01). If you are using Metric paper sizes, refer to the printer manual for the appropriate switch settings.

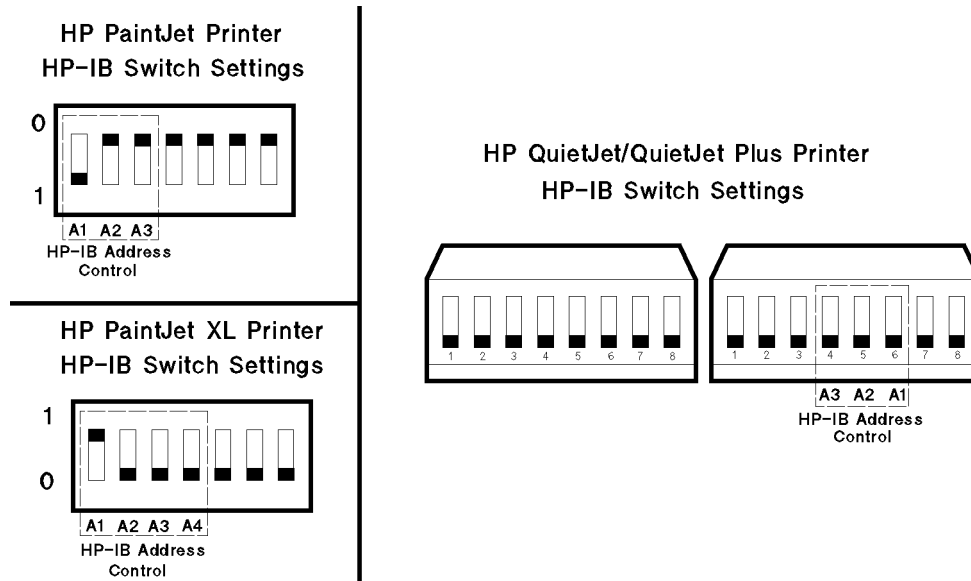

Figure 6-3. HP QuietJet and PaintJet (Family) Printer GPIB Switch Settings

Preparing the Printer for Use

1. Load the paper, then turn the printer ON.

On HP QuietJet, QuietJet PLUS, and PaintJet Printers (not XL):

2. Move the Paper Advance Knob (on the right-hand side of the printer) to advance the paper. Set the top of the page so it is just above the inkjet print head. These printers automatically set Top of Form to the current position when the paper Advance Knob is moved.

Configuring the Network Analyzer

Selecting Printer Resolution

(HP QuietJet and QuietJet Plus Printers)

The 8510C allows you to select two different print resolutions for HP QuietJet printers, 96 and 192 dots per inch (DPI). To choose a specific resolution:

1. Press **(COPY)** **DEFINE PRINT** **MORE** **PRINTER RESOLUTION**.
2. Enter the desired value using the keypad, and press **(x1)**.

Note Higher resolutions take longer to print. Refer to “Printing” towards the end of this chapter for instructions on making actual printouts.

Selecting Printer Resolution (HP PaintJet and PaintJet XL Printers)

The only resolutions for these printers is 90 or 180 DPI. This resolution is selected automatically when you select color printing (see below).

Printing In Color

If using the HP PaintJet or PaintJet XL printers, set the 8510C for color printing as follows:

Press **COPY** **DEFINE PRINT** **COLOR**. Making this selection automatically sets the printer resolution for an HP PaintJet or PaintJet XL printer (90 and 180).

Now refer to “Printing” towards the end of this chapter for instructions on making actual printouts.

Using an HP ThinkJet Printer

Choose the serial (RS-232) or GPIB setup, depending on how your printer is equipped.

Using Serial Setup

Connect the printer as explained in the service manual.

Setting the Serial DIP Switch

Make sure all DIP switches (mounted on the back of the printer) are down (off). These recommended switch settings assume you are using 8.5 by 11 inch paper. If you are using Metric paper sizes, refer to the printer manual for the appropriate switch settings.

Setting Up for GPIB

Connect the printer as explained in the service manual.

Setting the GPIB Address DIP Switch

The 8510C uses address 01 as the default GPIB address for printers. Figure 6-4 shows proper switch settings (with the GPIB address set to 01). These recommended switch settings assume you are using 8.5 by 11 inch paper. If you are using Metric paper sizes, refer to the printer manual for the appropriate switch settings.

Printer Setup

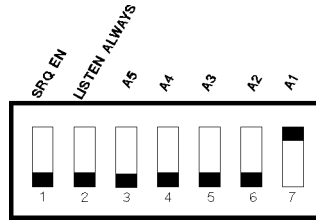

Figure 6-4. HP ThinkJet Printer GPIB Switch Settings

Preparing the Printer for Use

1. If using metric paper sizes, refer to the printer manual for setup instructions.
2. Turn the printer ON.
3. Load the fan-fold paper. Use the **(LF)** key to advance the paper. Set the top of the page so it is just above the inkjet print head.
4. Turn the printer OFF, then ON to set top of form.

Configuring the Network Analyzer

Selecting Printer Resolution

The 8510C allows you to change printer resolution. The HP ThinkJet printer, however, can be used only with the 96 dots per inch (DPI) setting. To check the current printer resolution setting:

1. Press **(COPY) DEFINE PRINT MORE PRINTER RESOLUTION**.
2. If necessary, press **(9) (6) (x1)**.

Refer to “Printing” towards the end of this chapter for instructions on making actual printouts.

Using Non-HP Printers

Choose the serial (RS-232) or GPIB setup, depending on how your printer is equipped.

Using Serial Setup

Connect the printer as explained in the service manual.

Setting the Serial DIP Switch

Refer to your printer's user's guide. Make sure the following settings are made:

Table 6-1. Serial Printer Settings for Other Printers

Item	Proper Setting
Serial ¹	ON
BAUD Rate	9600
Parity	None
XON-XOFF/DTR	XON-XOFF
7/8 Bits	8 Bits
Stop Bits	1

¹ Most laser printers must be set to SERIAL mode by the user.

Setting Up for GPIB

Connect the printer as explained in the service manual.

Setting the GPIB Address DIP Switch

Refer to the printer's User's guide for instructions. The default address used by the 8510C is 01.

Pre-Printing Check-Out

Load paper and, if using fan-fold paper, align the paper properly. Turn the printer ON, set top of form.

Now refer to the Printing or the Plotting sections in this chapter for instructions about making actual printouts.

Printing

Printing

The printing feature allows you to:

- Print an exact copy of the display
- Print tabular data
- Print instrument settings and system configuration

Printouts can be made in Portrait or Landscape mode.

Printing Orientation: Either Landscape or Portrait

Next, define the print orientation. Select either **PRINT PORTRAIT** or **PRINT LANDSCAPE**. Portrait orientation is the factory default. See Figure 6-5 and Figure 6-6.

Press **MORE** to set the printer resolution, margins widths, and total print width.

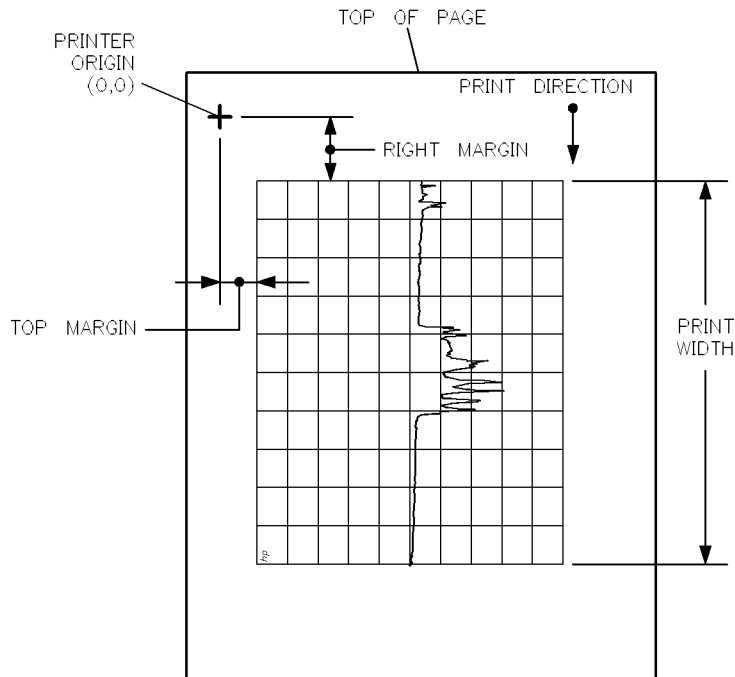

Figure 6-5. Landscape Printer Orientation

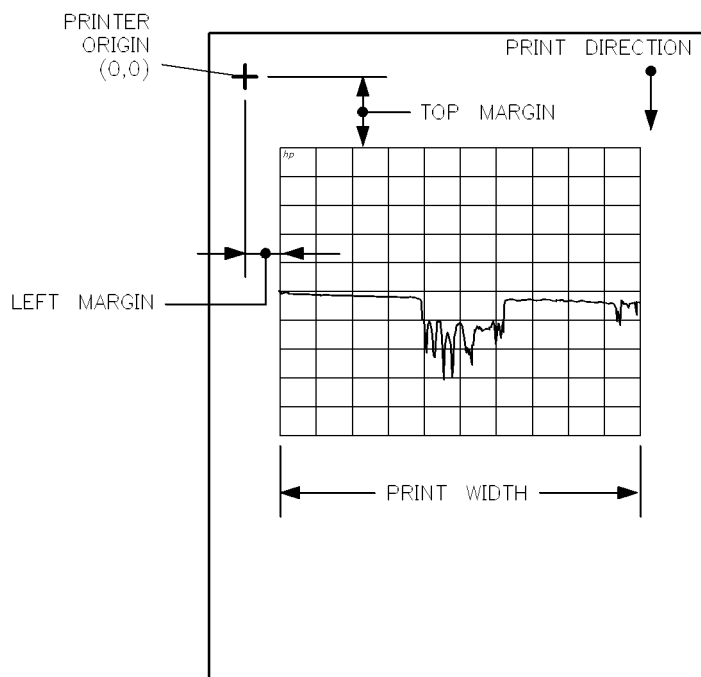

Figure 6-6. Portrait Printer Orientation

Printing One Snapshot per Page (Portrait or Landscape)

Two printout sizes are available, 1/2 page (use portrait mode) and full page (use landscape mode).

1. Select Portrait or Landscape orientation by pressing: **COPY** **DEFINE PRINT**, then press **PORTRAIT** or **LANDSCAPE**.
2. Press **AUTO FEED ON**.
3. To print, press **PRIOR MENU** **PLOT TO PRINTER**.

Printing Two Snapshots per Page

By leaving the Auto Form Feed feature OFF, and Portrait mode ON, two screen snapshots can be printed to a single page:

1. Press **COPY** **DEFINE PRINT** **PORTRAIT** **AUTO FEED OFF**.
2. Press **PRIOR MENU** **PLOT TO PRINTER**. The printer starts printing the first snapshot. (Laser printers show a flashing LED or uses another data transfer indication.)

Note Once you have pressed **PLOT TO PRINTER**, wait until **PLOT COMPLETE** is displayed before you press *any* other front panel key (otherwise the print aborts).

Printing

3. After PLOT COMPLETE appears on the screen, you can press keys on the 8510C. Before printing the second snapshot, you can change instrument settings, make another measurement, or load data from disc.

HP PaintJet XL printers stops printing when the first snapshot is 3/4 complete. This is normal, it finishes the snapshot when you perform the next step.

4. Press **COPY** (if necessary), then **PLOT TO PRINTER**. The next snapshot is sent to the printer.

If using a laser printer, the data transfer indicator starts flashing again. *Wait for the laser printer transfer indicator to stop flashing before proceeding to the next step.*

HP PaintJet XL printers stop printing when the second snapshot is 3/4 complete. This is normal, it finishes the snapshot when you perform the next step.

5. When the printer stops printing (or when the laser printer data transfer light stops flashing), press **DEFINE PRINT FORM FEED**. (This step is not required if you are using an HP ThinkJet Printer.)

FORM FEED causes fanfold-paper printers to go to the top of the next page. It causes laser printers to eject the page.

Alternatively, you can press **FORM FEED** on the printer. (Some printers must be taken OFF LINE before you can form feed.)

Note If you abort a printout, always use form feed to eject the partial printout. This is especially important on laser printers, otherwise a portion of the aborted snapshot is superimposed on your next printout.

Printing Tabular Measurement Data

You can print out all measurement data points for the active parameter, or for all four parameters in the active channel:

1. Select Auto feed by pressing **COPY** **DEFINE PRINT** **AUTO FEED ON**.
2. To print, press **PRIOR MENU** **LIST TRACE VALUES**.
 - a. To print data for the active parameter only, press **LIST ONE PARAMETER** in the new menu.
 - b. To print data for all four parameters, press **LIST ALL PARAMETERS**.

The list below shows an example of an Frequency Domain list trace value output.

FREQUENCY (HZ)	dB
7.5000000000E+09	-4.0609370000E+01,
0.0000000000E+00	
7.5062500000E+09	-4.0003900000E+01,
0.0000000000E+00	
7.5132500000E+09	-3.9474610000E+01,
0.0000000000E+00	
7.5198750000E+09	-3.8996090000E+01,
0.0000000000E+00	
7.5265000000E+09	-3.8386710000E+01,
0.0000000000E+00	

The first column is the always the stimulus value, followed by two columns of trace values in the basic units selected by the current FORMAT selection. If the marker value consists of a single value, for example LOG MAG or PHASE, the second column is zero.

Changing the Tabular Data Format

To change the format of the list trace data, press **COPY** **DEFINE LIST**. This displays the define list menu as shown in Figure 6-7.

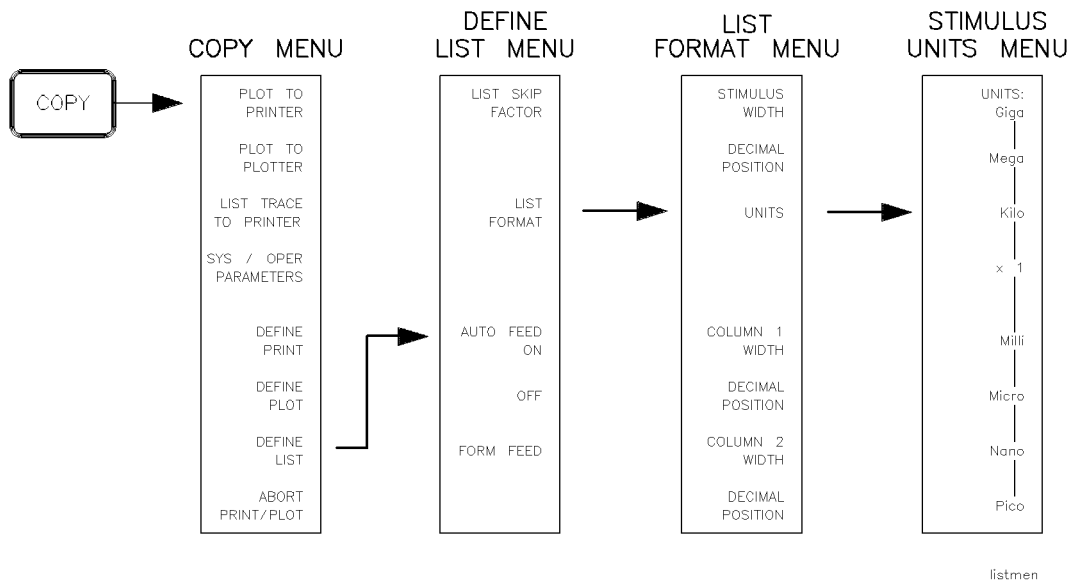

Figure 6-7. Define List Menu

You can define various format aspects of the printed tabular data.

The number of lines of data printed depends upon the number of points selected (Stimulus menu) and the list skip factor. When the skip factor = 1, all frequency points are printed. When the skip factor = 2, every other frequency point is printed, and so on with larger skip factors. At skip factor = 4 (default value) with 201 frequency points of data, the list contains 51 points of information, one full (8.5 x 11 inch) page. To set skip factor, press **LIST SKIP FACTOR** and use the knob or numeric entry keys to enter a value.

Printing

Press **LIST FORMAT** to view the menu selections that control the column formats.

You can adjust the overall number of characters of the printed stimulus data as well as the decimal position and the units selected. Select **STIMULUS: WIDTH** and use the knob or numeric entry keys to enter a number representing the desired number of characters. The minus sign and decimal point are counted as characters. The column heading varies with the domain currently active. Select **STIMULUS DECIMAL POSITION** to set a value that represents the number of digits after the decimal point. Select **STIMULUS UNITS** to view the available stimulus unit selections.

The column 1 and column 2 information is formatted in similar manner.

COLUMN 1 WIDTH sets the overall number of characters printed for column 1 and

COLUMN 1 DECIMAL POSITION sets the number of digits after the decimal point.

COLUMN 2 WIDTH and **COLUMN 2 DECIMAL POSITION** set the column 2 format aspects.

For those printers with automatic paper feed capabilities you can select: **FORM FEED** to cause a page to automatically eject from the printer and **AUTO FEED ON/OFF** to set the automatic next page load to either on/off.

Printing Instrument Settings and System Configuration

The Copy menu also makes it possible to document the 8510C system configuration (System Parameters) and instrument settings (Operating Parameters). Refer to Figure 6-8 for the menu.

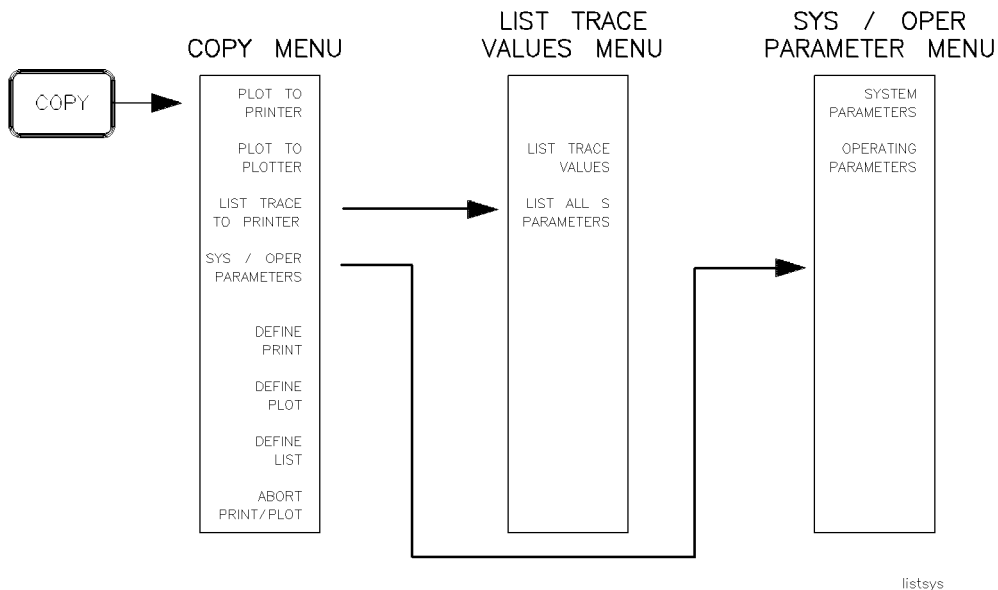

Figure 6-8. System/Operating Parameters Menu

To display the current system operating parameters, press **SYS/OPER PARAMETERS**, then press **SYSTEM PARAMETERS** or **OPERATING PARAMETERS**.

Next, press **LIST PARAMETERS** or **PLOT PARAMETERS**, depending on whether you have a printer or plotter. Current page position and pen number are used for the plot. To restore the measurement display, press the softkey **RESTORE DISPLAY** or any front-panel key other than a softkey.

Refer to **SYSTEM PARAMETERS** and **OPERATING PARAMETERS** in the *Agilent 8510 Keyword Dictionary* for typical displays of these parameters.

Installing a Plotter

Using a Plotter

This section explains:

- Installing the Plotter
- Plotting Options
- Plotting

Plotting Features

The plotting feature allows you to:

- Plot an exact copy of the display (a “snapshot”).
- Plot selected display components, such as the data, graticule, markers, or text.
- Plot in one color (monochrome) or in multiple colors (color).
- Plot one snapshot per page
- Plot four snapshots per page.
- Select specific pens and pen colors.

What Is Plotted?

The displayed measurement can be plotted out exactly as displayed on the screen, or you can print certain screen components such as the data, graticule, markers, or text only. The softkey menus do not appear on plots unless asked for using a GPIB command. The marker list and real-time clock are always plotted if they are active, unless menus are being plotted.

Installing a Plotter

Installation is described in the *Agilent 8510C On-Site Service Manual*.

Selecting the Output Port

Select the appropriate output port for your plotter as follows:

1. Turn the network analyzer ON.
2. If using a serial plotter: Press **LOCAL** **MORE** **PLOTTER: RS-232 PORT #1** or **PLOTTER: RS-232 PORT #2**, depending on which serial port you used.
3. If using a GPIB plotter: Press **LOCAL** **MORE** **PLOTTER: HP-IB**. The message **PLOTTER HP-IB ADDRESS 5** appears on the screen.

Connecting the HP 7550, Special Instructions

HP 7550 plotters have two RS-232 ports, however, *the two ports are wired differently*. You should use the male RS-232 port (marked “COMPUTER”). *The RS-232 cables shipped with the HP 8510C do not work with the HP 7550, you must order an HP 24542H cable.*

HP 7550B and 7550 Plus plotters must be placed in “7550A Emulation” mode, with TIMEOUT turned Off. Refer to the HP 7550B or Plus User’s Guide for instructions.

Using HP 7550B and HP 7550 Plus Plotters

The HP 7550A/B plotter is configured using its front panel controls. To use either of these plotters you must do the following:

- Select HP 7550A emulation mode.
- Turn the TIMEOUT feature Off.

Instructions on how to perform these steps are provided in the HP 7550B or 7550 Plus User’s Guide.

Plotting Options

Press **COPY** to display the Copy menu (Figure 6-9). Press **DEFINE PLOT**, and select any of the following plotting options:

- Choose **PLOT TYPE: MONOCHROME** (to use one pen only) or **PLOT TYPE: COLOR** (to use all pens).
- Choose different pens for parameter 1, 2, 3, and 4 traces, or for the graticule, using **SET PEN NUMBERS** (if your plotter has multiple pens).
- Turn Auto Form Feed ON or OFF.
- Choose full page or 1/4 page plot size using **SELECT QUADRANT** and either select **FULL PAGE** or one of the four quadrant softkeys.

The softkeys **AUTO FEED ON/OFF** and **FORM FEED** apply to plotters with automatic paper feed capabilities. **FORM FEED** causes a page to automatically eject from the plotter. **AUTO FEED ON/OFF** sets the automatic next page load to either on/off.

Selecting Plotter Pen Color

For multiple-pen plotters, each display component can be plotted using a different pen/color using the softkey **SET PEN NUMBERS** on the Copy menu.

1. Press **COPY** **DEFINE PLOT** **PLOT TYPE: COLOR** **SET PEN NUMBERS**, then press the softkey corresponding to the display element for which you wish to select a pen number. Insert the pen in the plotter pen slot corresponding to the number selected for that display element. Continue to select pen numbers for the other display elements in the same way.

Plotting Options

2. Press **COPY** to return to main Copy menu. Select **PLOT TO PLOTTER** and then the softkey corresponding to the material you wish plotted using the pen numbers just chosen: **PLOT: ALL**, **DATA**, **MEMORY**, **GRATICULE**, **MARKER(S)**, **TITLE**, or **TEXT**.
3. If you selected a single element, wait for the plot to be completed, then repeat the process as often as needed to complete the multi-pen plot.

Plotting with a Single Pen Color

The following sequence causes the entire plot to be drawn using a single pen.

```
COPY  
DEFINE PLOT  
PLOT TYPE: MONOCHROME  
PRIOR MENU  
PLOT TO PLOTTER  
PLOT: ALL
```

Pen selections are saved as part of the Instrument State. The following is a list of the factory default pen number assignments selected also, by the softkey **DEFAULT PEN NUMBERS**.

Table 6-2. Default Pen Numbers

Display Element	Pen Number	Display Element	Pen Number
SOFTKEYS	1	MARKERS	1
WARNING	2	PARAM 1	3
PARAM 1	3	MEM	
DATA		PARAM 2	5
PARAM 2	5	MEM	
DATA		PARAM 3	6
PARAM 3	6	MEM	
DATA		PARAM 4	4
PARAM 4	4	MEM	
DATA		STIMULUS	1
GRATICULE	1		

Plotting

You can plot a single 0 per page, plot only a portion of the display, or plot all four quadrants on a page.

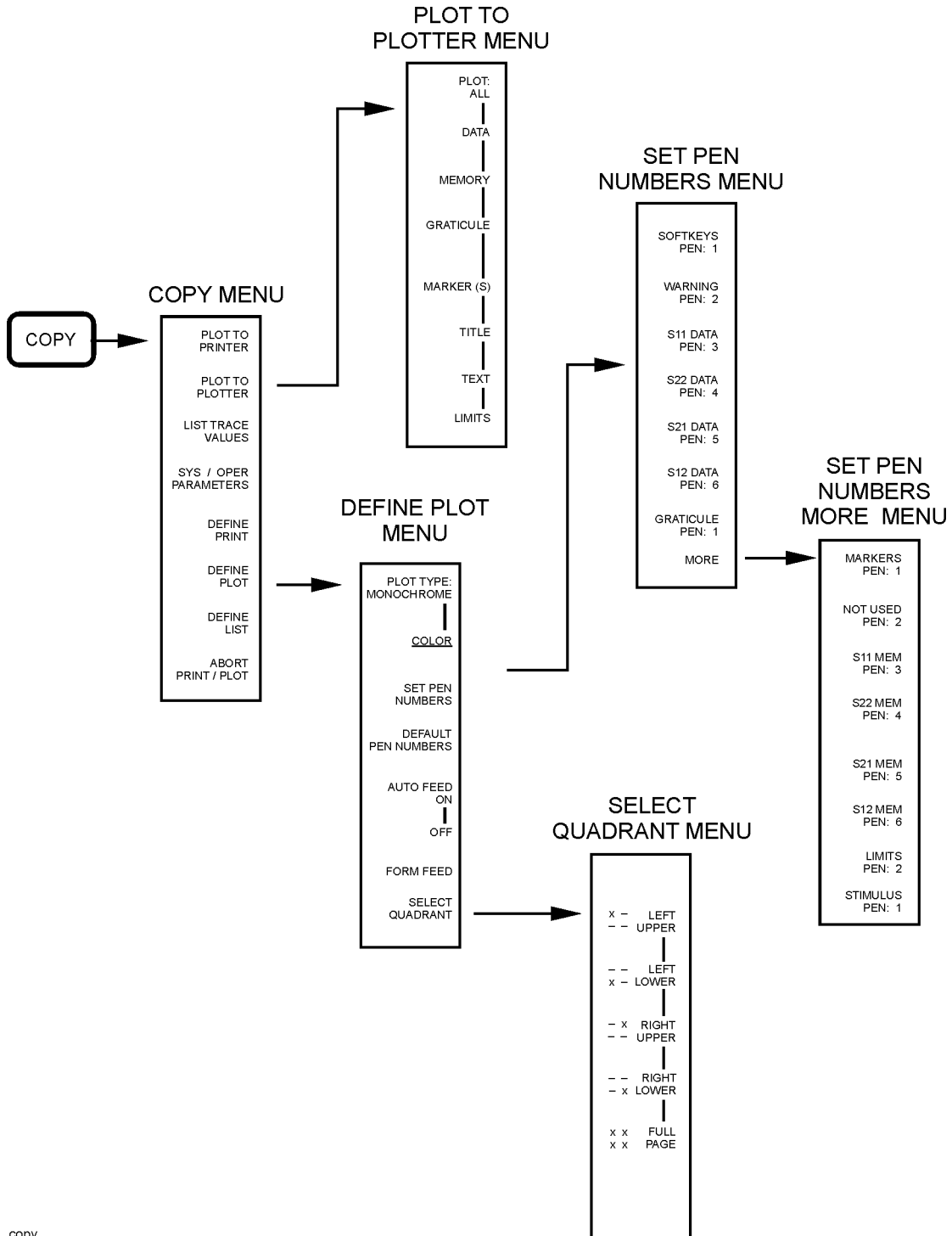

copy

Figure 6-9. Define Plot and Plot to Plotter Menu Structure

Plotting

Plotting One Snapshot per Page

1. Press **(COPY)** **DEFINE PLOT** **SELECT QUADRANT** **FULL PAGE**.
2. Press **(COPY)** **PLOT TO PLOTTER**, and the plotting starts.

If the marker list feature is on, it is plotted when **PLOT ALL** is executed. The same is true of the date/time clock feature.

Plotting Individual Display Components

To plot only part of the display, press **(COPY)**, **(PLOT TO PLOTTER)**, followed by one of the following:

- **PLOT: ALL**
- **DATA**
- **GRATICULE**
- **MARKER(S)**
- **MEMORY**
- **TITLE**
- **TEXT**
- **ALL FOUR PARAMETERS**.

To plot more than one of these (for example to plot the trace and then the graticule), wait for the first plot to be completed, then, without changing the plotter paper, press the softkey corresponding to the other component you want to plot. Note that on certain plotters you may have to load the paper again before the plot begins.

Plotting a Selected Quadrant Four Snapshots per Page

Factory Preset selects full page plots. The current selection is shown underlined on the select quadrant menu.

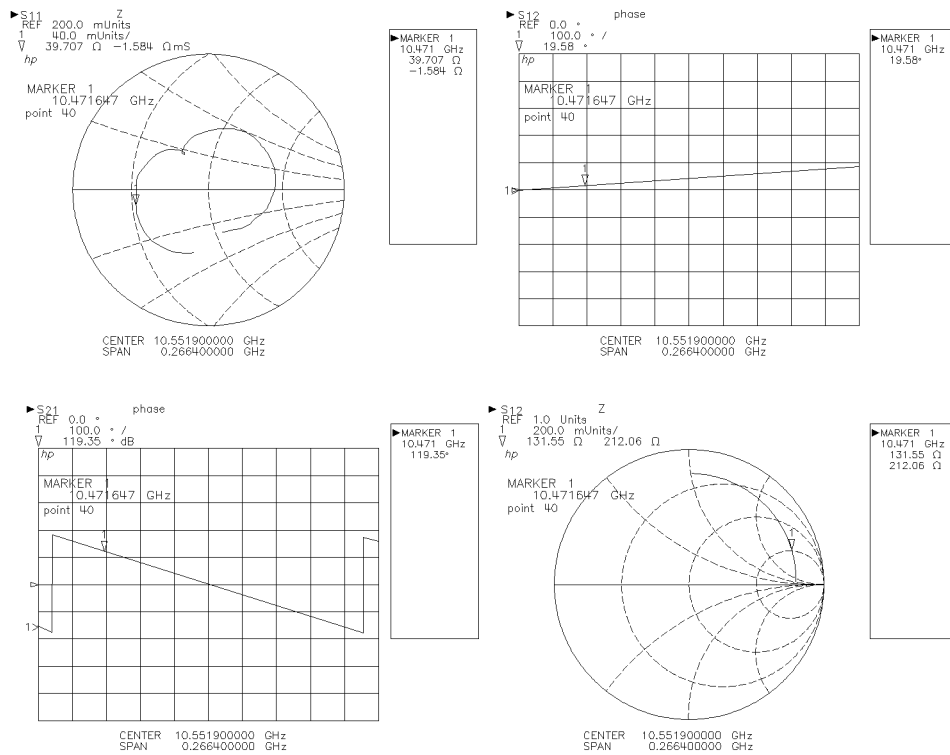

Figure 6-10. Four-Quadrant Plot Example

To plot all or part of the display at approximately quarter-page size:

1. Press **COPY** **DEFINE PLOT** **SELECT QUADRANT**. This displays the plot quadrant menu.
2. Select the quadrant for the first plot by pressing **LEFT UPPER**, **LEFT LOWER**, **RIGHT UPPER**, or **RIGHT LOWER**.
3. Press **COPY** **PLOT TO PLOTTER** **PLOT: ALL** or one of the softkeys for plotting only part of the display.

The material selected is plotted at approximately one-quarter size in the location you have specified. To select the location for the next plot, select the next quadrant, select the location, then select the material to be plotted. Repeat the process for the next plot. Note that on certain plotters you may have to load and reload the paper to complete all four plots.

Disk Drive Operation

Features

Features under the **DISK** key allow you to save measurement, calibration, or instrument state information to disc. This information can be retrieved when desired. You can use the built-in internal disk drive, or compatible external disk drives. External drives must be connected to the system bus. You can control these devices using the **DISK** key in the AUXILIARY MENUS block, and its associated menus.

The **DISK** key and related menus allow you to:

- Store files (save various types of data to internal or external disc).
- Load files (load a disk file containing data).
- Delete files from internal or external disc.
- Un-Delete the last file you deleted.
- View a directory of files
- Initialize new discs.
- Use internal or external disk drives.

Both internal disk and SS/80 type external disk drives can provide data storage for instrument states, calibration error coefficient sets, calibration kit definitions, measurement data, memory data, hardware states, user display memory, delay table, or machine dump (these terms are defined later in this chapter).

Compatible Disk Types, Disk Storage Capacity

The network analyzer can initialize floppy discs using DOS format or Logical Interface Format (LIF). DOS format is used by PC compatibles, LIF is used by HP 9000 series 200/300 workstations. The HP 8530 uses high-density or low-density 3.5 inch discs. *Use only certified double-sided discs or you may cause excessive wear to the disk drive.*

Table 7-1. Disk Storage Capacities

Disk Type	LIF Capacity	DOS Capacity
Low Density	622 Kbytes	720 Kbytes
High Density	1.244 Mbytes	1.44 Mbytes

DISK Functions

DOS Subdirectories

The 8510C can only access files on the “root” directory of a disc. Files cannot be accessed in DOS subdirectories.

Disk Menu

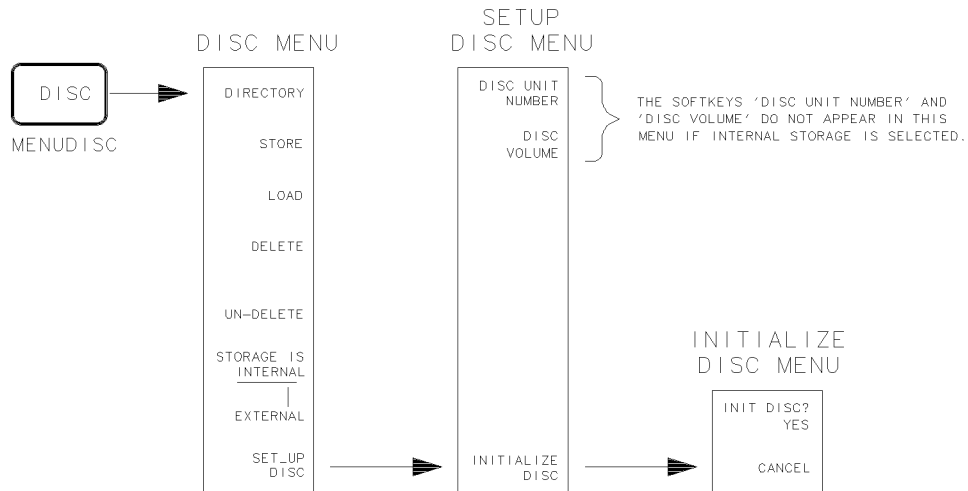

discmenu

Figure 7-1.
Disk Menu, Data Type Select Menu, Setup Disk Menu,
and Initialize Disk Menu

ASCII and Binary File Types

The network analyzer can save some file types in binary file format, and others in ASCII format. The format used for each type of data cannot be changed by the user, and are listed in Table 7-2.

All other types of data are saved as shown in Table 7-2.

Binary data files require less disk space and the file transfer is faster. If the cal set file is to be read by a computer, use ASCII format.

Table 7-2 shows the information you can store to internal or external disk drives, and the data format the network analyzer uses when saving it (ASCII or binary).

Table 7-2. Information You Can Store to Disc, and How it Is Saved

Files Saved in ASCII Format	Files Saved in Binary Format
Memory data	Network Analyzer Calibration Kit
RAW measurement data	Calibration kit definitions
DATA (corrected) measurement data	The user portion of the display memory
FORMATTED measurement data	Hardware state
The electrical delay table	Instrument states
Calibration error coefficient sets	Machine dump

The ASCII data is saved in the CITIfile ASCII format. CITIfile adds informative headers to the information in the file, and allows data to be exchanged with the Agilent Microwave Design System. Complete information on the CITIfile format is provided at the end of this chapter.

Changing between DOS and LIF Discs

When you insert a formatted disc, the network analyzer can automatically tell whether it is LIF or DOS format. The only time you must choose between LIF and DOS is when you initialize discs.

Initializing Discs

1. Before you initialize a floppy disk make sure the write-protect tab is completely shut.
2. Insert the disk with the label-side facing left.
3. Press **(DISK) SETUP DISK**.
4. To initialize the disk using DOS format, press **INITIALIZE DOS DISK INIT DOS? YES**.
5. To initialize the disk using LIF format, press **INITIALIZE LIF DISK INIT LIF? YES**.

The initialization process takes about 2 minutes 20 seconds per disc.

Note The disk drive has a light that comes ON when the disk is being accessed. Do not eject the disk when this light is ON or you could lock-up the network analyzer. If this occurs, simply place the disk back into the drive.

Storing Disk Files

Files that are associated with *internal instrument operation* (instrument states, hardware states, machine dumps, and so on) are stored in binary format. *Measurement data* is always stored in “CITIfile” ASCII format. The “CITIfile” format has informative headers, and allows data to be exchanged with other programs. Complete information on the CITIfile format is provided at the end of this chapter.

1. Insert an initialized disc.
2. Press **DISK** **STORE**.
3. Choose the type of file by pressing one of the following keys:

INST STATE 1-8

Press this softkey, then select the instrument state register you want to store to disc.

INST STATE ALL

Press this softkey to store all eight instrument states to one file.

MEMORY 1-8

Press this softkey, then select the memory register you want to store to disc.

MEMORY ALL

Press this softkey to store all eight memories to one file.

CAL SET 1-8

Press this softkey, then select the cal set you want to store to disc.

CAL SET ALL

Press this softkey to store all eight cal sets to one file.

CAL KITS

Press this softkey, then select the cal kit definition you want to store to disc.

Press **MORE** to see the following choices:

DATA: RAW	Press this softkey to store the raw data array for the active channel.
DATA	Press this softkey to store the calibrated data array for the active channel.
FORMATTED	Press this softkey to store the formatted data array for the active channel.
DELAY TABLE	Press this softkey to store the electrical delay table to disc.
USER DISPLAY	Press this softkey to store User Display graphics to disc.
HARDWARE STATE	Press this softkey to store multiple source mode settings, GPIB settings for external hardware, and test set (frequency converter) states.
MACHINE DUMP	Press this softkey to store the following instrument registers to a single disk file: <ul style="list-style-type: none"> a. Current instrument state b. Instrument states 1 – 8 c. Cal sets 1 – 8 d. Cal kits e. Hardware state f. Memories 1 – 8

When you load a machine dump from disc, the contents of these internal registers are replaced with the data from the machine dump file.

NOTE: Before saving a machine dump file, store your current measurement setup in Save Register 8 (the user preset/power ON register). Later, when that machine dump is loaded, the network analyzer will wake up in that state. When a machine dump file is loaded, the network analyzer wakes up with whatever is in Register 8. The machine dump does not automatically remember your desired setup *unless* it is stored in Register 8.

4. A “label maker” menu will appear. Notice that the menu has a list of alpha-numeric characters and a selector arrow. The file name prefix for the selected type of data will already be entered for you.

If you want to overwrite an existing file, press **REPLACE FILE**. A list of the current disk files will appear on screen. (The network analyzer will only list the type of files selected in step 3. For example, if you are storing a Raw data file, only raw data files will be shown in the directory listing.)

Use the knob or ▲ ▼ keys to select the file you want to replace, then press **REPLACE FILE**. The instrument will now store the file to disc.

DISK Functions

5. If you are creating a new file, enter the desired file name as follows:
 - a. Using the rotary knob, place the cursor under the first desired letter or number. Press **SELECT LETTER**. If you make a mistake, press **BACK SPACE**. Continue until you have selected all desired characters. You can enter up to seven characters. Note: If saving to DOS discs, the sixth and seventh characters will become a file name extender (for example: RD_12345.67).
 - b. When you are done entering file name characters, press **STORE FILE** to store the file to disc.

The error message **CAUTION: DISK IS WRONG FORMAT, INITIALIZE TO USE** means:

- A. The disk has never been initialized.
- B. The disk is not a compatible format. Apple 0 (GCR) format is not compatible, for example. Use a DOS or LIF compatible disc, or copy any important files off the disk and initialize it in DOS or LIF format.

Loading Disk Files

You can load files in any sequence with the following considerations:

- Before loading measurement data, turn on hold mode by pressing:

STIMULUS **MENU** **MORE** **HOLD**

- Otherwise the data you load will be immediately overwritten with new data.
- In Frequency Domain, the currently-selected number of points must match the number of points in the data file. For example, if you want to load a Frequency Domain data file with 801 points, make sure you set the 8510C to Frequency Domain mode, and select STIMULUS **MENU** **NUMBER of POINTS** **801**.

If you do not perform these initial steps, the current “number of points” may not match the number of data values in the disk file. If this occurs, an error message similar to the following will appear:

CAUTION: UNABLE TO LOAD 181 POINTS

- If you load Raw data, the network analyzer places it in the Raw data array, and performs all subsequent data processing functions on it. This includes calibration (if turned on) as well as all display formatting. After all processing is done, the data appears on the screen.
- If you load “Data” data (corrected data), the network analyzer places the data in the Corrected data array, and performs all display formatting. After all processing is done, the data appears on the screen.
- Calibration must be turned OFF when you load cal sets.
- If the display memory feature is ON (a memory trace is displayed on the screen), you can only load memory data files into *empty* memory registers. If the display memory feature is OFF, you can load memory data files into *any* memory register.

Loading a File

Perform the following steps to load a disk file.

1. Press **DISK** **LOAD**.
2. Now choose the type of file you want to load.
3. If you choose to load an instrument state, memory, cal set, or cal kit:
 - a. Choose the specific destination register. For example, if you choose **CAL SET 1-8**, the network analyzer now displays **CAL SET 1** through **8** register choices. Select the desired register to hold the cal set data.

If you select any other data type, you do not have to select a destination register.

4. A “file selector” box now appears on the screen. The file selector shows a directory of all files of the desired type. For example, if you chose **CAL SET 1-8**, the file selector lists only the *cal set files* on the disc.
5. Use the **▲ ▼** keys or knob to highlight the desired file, then press **LOAD FILE**. The file will now load from disc.

Viewing a Directory of Files

Press **DISK** **DIRECTORY** to display a directory of all the files on the inserted disc. Each disk can hold many files in each data type. There are often more files on the disk than can be seen at one time. Use the knob to scroll through the file listing.

Each 8510C data file type has a three-character prefix. The prefix is convenient for two reasons:

- It allows the 8510C to show only the files of a specific type. When you are loading a Cal Set file, it is convenient to see a listing that only includes that type of file.
- If you are performing a directory listing of the disc, the prefixes show the exact type of each file.

Table 7-3. File Types and Prefixes

File Type	Prefix	File Type	Prefix
Cal Kit	CK_	Instrument State All	IA_
Cal Set	CS_	Raw Data	RD_
Cal All	CA_	Data	DD_
Memory File	DM_	Formatted	FD_
Memory All	MA_	Display	UD_
Inst State	IS_	Delay Table	DT_
Hardware State	HS_	Machine Dump	MD_
Program	PG_		

Deleting Disk Files

DELETE eliminates the specified file from the disc. To delete a file:

1. Press **(DISK) DELETE**.
2. Now select the type of file you wish to delete.
3. A File Selector box will now appear on the screen, listing all disk files of the selected type. Place the box-shaped cursor over the file you wish to delete (using the knob or ▲ ▼ keys).
4. Press **DELETE FILE**. The file will be deleted. If you made a mistake and really did not want to delete the file, un-delete the file as explained below.

Un-Deleting Disk Files

This feature only works on discs that have been formatted in the Logical Interchange Format (LIF).

Press **UN-DELETE** to restore the most recently deleted file. You cannot retrieve a deleted file if any of the following actions occur:

- If you store another file on the disk after the deletion.
- If you remove the disk and then reinsert it.
- If you delete a second file. (The un-delete feature only works on the *last* file you deleted.)

Using an External Disk Drive

Compatible Disk Drives

An external disk drive must be GPIB compatible. It must be able to use the Hewlett-Packard SS/80 protocol, and be capable of being formatted to 256 bytes per sector.

You can use a floppy disc, hard disc, or combination hard/floppy drive.

Disk Unit Number and Disk Volume

The softkeys **DISK UNIT NUMBER** and **DISK VOLUME** only apply to external disk drives.

Connections and Configuration Settings

Install the drive using the installation portion of the disk drive's operating manual, and by following the instructions below. If you have a hard drive, read about setting up "volumes" in the drive's manual. Hewlett-Packard hard discs can be partitioned into two or more volumes, which act like separate drives.

1. Connect the external drive to the network analyzer's System Bus.
2. Select the number of desired hard disk volumes using the hard disc's rear panel selector.

3. Make sure the external drive's GPIB address matches the address in the network analyzer's GPIB address menu (press **LOCAL** **MORE DISK**). You can change the address shown in the address menu by entering the actual address followed by the **x1** key. Alternatively, you can change the GPIB address switches on the external disk drive. Turn the disk drive Off, then On if you change its GPIB switch settings.
4. Press **DISK** **STORAGE IS EXTERNAL** then **SET UP DISK** to select the unit and volume number (explained below).
5. If using a disk drive that has more than one drive mechanism (unit), you must select the specific drive you want to use. The default is 0 (usually the left drive on a dual floppy drive, or the hard disk in a floppy/hard disk combination drive).

If you want to use the right-hand drive (in a dual floppy system), or the floppy drive in a hard disc/floppy drive:

Press **DISK** **SET UP DISK** **DISK UNIT NUMBER** **1** **x1**.

Refer to the disk drive's operating manual to verify the unit numbers used by your drive.

6. Hard drives can be partitioned into one or more "volumes." Volumes act like separate drives, even though they are, in fact, part of the same physical disc. A control wheel on the back of the hard disk selects the number of volumes that can be used. Select the specific volume you want to address by pressing:

DISK **SET UP DISK** **DISK VOLUME**, then enter the desired volume number and press **x1**. Volume 0 through 7 may be specified. Factory Preset selects volume 0.

Note You must initialize each hard disk volume before use. Refer to "Initializing a Hard Disc" later in this section.

If the disk drive does not respond to subsequent commands, the message **NO DISK** is displayed. Check the disk address again (both on the unit itself and in the network analyzer's **LOCAL** Menu). Also check and the unit and volume number again.

Initializing a Hard Disc

If using a hard disk for the first time, you must initialize each volume. You can do this using a computer, or using the 8510C. To initialize the hard disk using the 8510C, follow these steps:

1. Set the volume number to 0 by pressing: **DISK** **SET UP DISK** **DISK VOLUME** **0** **x1**.
2. Press **INITIALIZE LIF DISK**.
3. Press **INIT LIF? YES**. Depending on the size of that volume, it will take between 10 to 30 minutes to initialize.
4. Select the next volume number (if using a multi-volume drive), and repeat steps 1, 2, and 3.
5. Repeat the above steps for each volume.

Guide to Saving Data

This section explains two common applications for saving data.

First of all, a more in-depth description of the different file types will be helpful in this discussion:

Instrument States These states contain front panel settings, including:

States

- Instrument settings
- Frequency list segments
- Whether calibration was On or Off
- Whether the Delay table was On or Off
- Whether user display was on or off
- The cal set in use (if any) for that state
- Whether electrical delay was On or Off

The instrument state does *not* keep track of calibration data, cal kit definitions, user delay table contents, or any settings that control external hardware.

Memory These store a display data trace. These stored traces can be viewed next to current data. Memory trace data can be used as an addend, subtrahend, multiplicand, or dividend of current data using trace math features.

Cal Sets A cal set contains all the error coefficients for a calibration you have performed.

Cal Kit Contains the mathematical models for the precision standards in a calibration kit.

Note: In the following descriptions, data is described as being affected by various features (averaging, calibration, and so on). Such user-selected features only affect the data when turned On.

Raw Data Raw data is averaged, but no other processing is performed. This data is stored in an internal memory array called the “Raw Data Array.” Raw data is composed of complex data pairs (real,imaginary) for each stimulus point.

“Data” Data This is measurement data that has been processed by calibration, electrical delay, the user-defined delay table, and time domain. “Data” data is stored in an array in complex data pairs.

Formatted Data This is measurement data that has been processed by trace math, smoothing, and has been formatted according to any display settings. If you have selected a Cartesian display format, formatted data is no longer a complex value, but is scalar (magnitude only). If you have selected Polar format, formatted data is a complex value.

Delay Table The delay table allows you to mathematically change each raw data point with a complex (real,imaginary) multiplier of your own choosing. The result is saved in the “Data” data array. The network analyzer multiplies each measurement data pair with the corresponding number pair in your delay table.

User Display Contains user-defined graphic elements drawn on the display.

Hardware State	These are mostly settings found under the <code>SYSTEM</code> or <code>LOCAL</code> keys. These settings control GPIB addresses, multiple source settings, and other hardware-related settings. The hardware state also controls the default RF source power.
Machine Dump	Stores the following registers: <ul style="list-style-type: none"> ■ All eight Instrument States ■ The Hardware State ■ All eight Memory registers ■ All eight Cal Sets ■ All Network Analyzer Cal Kits ■ Delay Table ■ User Display graphics

Sharing a System

Often several users must share the network analyzer. When you finish your session, it is useful to save your setup so you can begin working quickly during your next session.

In this application you should:

1. Store one or more instrument state files to disc, as needed. If you have saved many different instrument states, you may want to store them all at once using the `INSTR STATE ALL` softkey.
2. If you have performed one or more calibrations, store them to disc. If you used many different calibrations, you may want to save them all at once using the `CAL SET ALL` softkey. Save an instrument state for each cal set. This will ensure that you can recall the settings that are applicable for each calibration.

Calibrations are sensitive to ambient temperature and humidity, and therefore have a limited life span. In addition, a cal set's life can be limited because of changes to the system's components (including wear). You can use "old" calibrations if you measure a well-known device and compare the data to expected data. You can then decide whether or not the old calibration is still useful.

3. If using a special calibration kit, store the cal kit definition to disk too.
4. It is a good idea to save the hardware state to disc, especially if your network analyzer is controlling more than one source. The hardware state saves all multiple source settings. The hardware state also saves various GPIB settings for external hardware. You can skip this if the hardware setup rarely or never changes.
5. If using a user-generated delay table, store it to disc.
6. If you created special graphic elements, store them to disc.

Saving Everything

If you use a large number of states, cal sets, memories, and so on, you may find that storing using `Machine Dump` is easier. This takes longer than saving one or two individual types of data, and takes up more disk space. However, this may be the best method in complex situations.

DISK Functions

When you load a Machine Dump from disc, the contents of applicable internal registers are replaced with the data from the machine dump file.

A Machine Dump file *does not* automatically save the current *measurement settings*. Before saving a Machine Dump, always save the current measurement setup to save register 8. If you do this, the instrument will return to a known setup when you load the Machine Dump file.

Viewing or Plotting Old Data

If you know you want to plot, analyze, or view data at a later date, store the Raw, “Data,” or “Formatted” data to disc.

Calibrating for System Measurements

What Is a Measurement Calibration?

Calibration greatly reduces repeatable systematic errors from your measurements. A Measurement Calibration procedure transfers the accuracy of your calibration standards to the measurement of your device. Since the response of the standards is known to a high degree of accuracy, the system can measure one or more standards, then use the results of these measurements to provide data to algorithms which process the measured data for display. This process is called measurement calibration, accuracy enhancement, or error correction.

Use the information in this section for the following:

- Understanding fundamental concepts.
- Performing different types of measurement calibration.
- Saving calibrations.
- Understanding calibration standard principles and care.
- Evaluating calibration data.
- Using trim sweep.
- Modifying a calibration *kit*.
- Modifying a calibration *set*.

What Is Vector Accuracy Enhancement?

Vector accuracy enhancement techniques provide the means of greatly reducing the systematic errors in transmission and reflection measurements. This is achieved by first measuring the magnitude and phase response of standard devices, using this data to develop coefficients in a model of the measurement system, then measuring a test device and using vector mathematics to compute the actual test device response by removing the error contributions. The dynamic range and accuracy of the measurement is then limited by random and drift effects, the correctness of the model, and the accuracy to which the characteristics of the standard devices are known. This is the basic concept of vector accuracy enhancement.

Other publications discuss the causes of these errors, details of the accuracy enhancement error model, the physical aspects of the calibration standards, the mathematical response models of the standards, and the vector mathematics used to correct the measured data. Background theory and additional application information is described in the Agilent Application Note “Vector Accuracy Enhancement.”

Measurement Calibration

How the 8510 Corrects Measurement Data

In a typical application, the system is set up for a particular measurement.

- An appropriate measurement calibration is performed at each frequency point for each parameter to be measured.
- The calibration is saved in any of the eight calibration set memory registers.
- The device under test is connected, its response is measured, and then the data is corrected and output.

The following diagram shows a typical operating sequence used when the device under test is measured using more than one set of stimulus conditions (frequency range, number of points, source power).

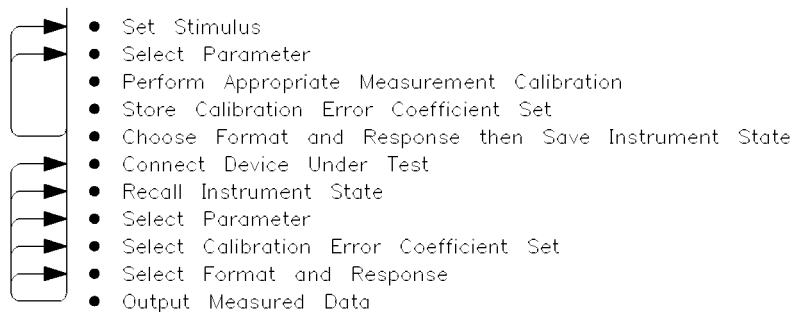

Calibration Requirements

There are several requirements you should be aware of before using the calibration feature.

Use the Same Stimulus and Parameter Settings in the Measurement

The Stimulus settings and Parameter used during the calibration must match those used during the calibrated measurement. You can use the eight calibration set memories and the eight instrument states together to provide eight instant-access measurement setups. For example, you could store the calibration data for a certain measurement in calibration set memory 1, and the proper instrument settings for that cal in storage register 1.

To make things simpler, however, the calibration memory automatically returns the instrument to the original stimulus settings. Therefore, all you have to do is:

1. Select the Parameter (S_{11} , S_{12} , S_{21} or S_{22}) that you used during the calibration. This step must be performed first.
2. Recall the calibration.
3. Now turn correction On and make the measurement.

Settings that should not be changed. *If you change Parameter:* If you change to a parameter that has no calibration associated with it, the calibration feature immediately turns itself Off. The message THIS PARAMETER NOT IN COEFFICIENT SET will appear.

If you change Frequency Range or Number of Points: Correction is automatically turned Off, and CORRECTION RESET is displayed.

8-2 Calibrating for System Measurements

If you switch between Ramp, Step, Frequency List, or Single Point mode: Correction is automatically turned Off, and **CORRECTION RESET** is displayed.

If you change Source Power, Sweep Time, Power Slope, Ramp/Step Sweep values, or Trim Sweep values: The message **CAUTION: CORRECTION MAY BE INVALID** is displayed. It is the user's responsibility to determine whether the change invalidates the calibration.

If you change ATTENUATOR PORT:1 ... 2 settings: Error correction is not turned off even though the displayed data may be in error. **CAUTION: CORRECTION MAY BE INVALID** is displayed.

Use the Same Equipment Setup in the Measurement

Always calibrate using the same adapters and cables that will be used for the measurement. If the adapters or cables are changed between calibration and measurement, unpredictable errors will result due to the fact that the error coefficients determined during calibration do not apply to the altered setup. Even disconnecting and reconnecting the same adapter can cause inaccuracy. If you change the setup, you must perform the measurement calibration procedure again to find appropriate error terms for the new setup.

Averaging

For all calibrations, use the same or greater averaging factor than will be used for the device measurement. In general, use an averaging factor of 8 or 16 for most measurements and increase the averaging factor to 64, 128, or 256, depending upon the dynamic range required for the measurement, for Isolation steps. This can be easily accomplished by turning Averaging On before beginning the calibration then leaving Averaging Factor as the active function during the calibration.

Coupled/Uncoupled Channels

With **COUPLED CHANNELS** selected, when you turn correction on for a parameter on one channel, it is also turned on for that parameter on the other channel. Selecting **UNCOUPLED CHANNELS** allows you to apply a different calibration set to the measurement on the other channel.

For example, to display real time responses of corrected and uncorrected data:

1. Perform a response cal for a parameter and turn correction on.
2. Press **DISPLAY** **DUAL CHANNEL OVERLAY**.
3. Select the same parameter for display on both channels. Notice that correction is On for both channels.
4. Press **CAL** **CORRECTION OFF**. Correction is turned off for both channels.
5. Press **STIMULUS** **MENU** **MORE UNCOUPLED CHANNELS**.
6. Press **CHANNEL 1** **CAL** **CORRECTION ON CAL SET n**. Correction is turned On only for Channel 1.

When **UNCOUPLED CHANNELS** is selected, correction off/on and the calibration set must be selected independently for each channel.

Measurement Calibration

Cal Menu

The Cal menu, the Cal Type menu, and the Cal Set Select menu are shown in Figure 8-1. Pressing the **CAL** key brings the Cal menu onto the display.

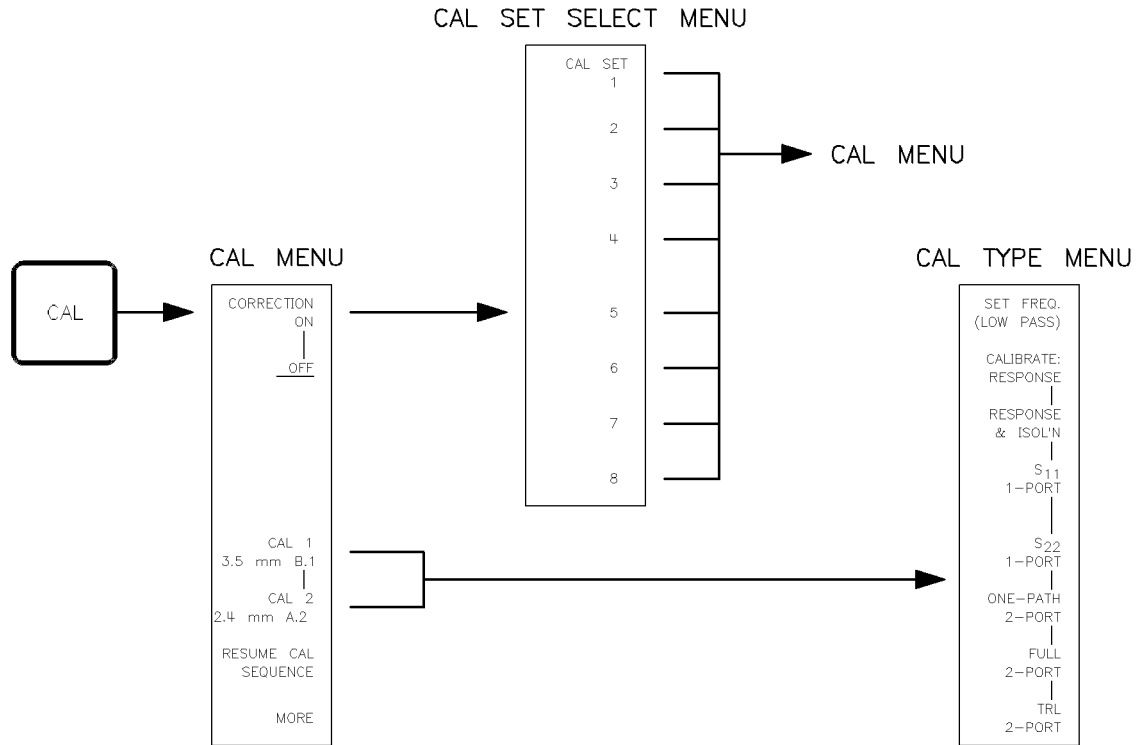

Figure 8-1. Cal and Cal Type Menus

Turning On an Existing Cal Set

CORRECTION OFF and **CORRECTION ON** provide selection of calibrated or non-calibrated vector measurement data. The **C** annotation and the number of the current calibration set (next to the **ON** label) show correction is applied to the measurement.

Pressing **CORRECTION ON** brings the Cal Set Selection menu onto the display and the message **SELECT CALIBRATION SET** onto the display. An asterisk (*) next to the calibration set number indicates that calibration error coefficients are already stored in that calibration set. Select a number to recall a calibration set and apply it to the measured data.

Performing a Measurement Calibration

This section contains the following information:

- A synopsis of the steps required to perform and save a calibration.
- A complete explanation of each major step.
- A step-by-step example of each available type of calibration.
- A procedure for verifying the accuracy of your calibration.
- A description of the calibration error model.

Calibration Process Synopsis

A calibration is comprised of the following steps:

1. Select the type of calibration kit you intend to use. Calibration kits are sold separately, and vary in cost and accuracy. This step is explained in “Step 1. Select a Calibration Kit”, next.
2. Choose the kind of calibration you need. Two factors are involved here:
 - a. How accurate you need the calibration to be.
 - b. What kind of measurement you are making.

This step is explained in “Step 2. Select the Type of Cal You Need”, next.

3. Connect and measure each required calibration standard device. This is explained in “Step 3. Measure all Required Standards”, later in this section.
4. Save the calibration to memory. This is explained in “Step 4. Saving the Cal Set to Memory”.
5. Store the calibration to disc if desired. This is explained in “Storing Calibration Data to Disc”.

Exiting and Resuming a Calibration Procedure

The **RESUME CAL SEQUENCE** key allows you to exit the calibration sequence currently in progress, for example to change the averaging factor, then reenter at the same point in the sequence. As you learn the calibration menus, you will see the standards are divided into classes, such as SHORT or THRU, and that the classes are divided into groups, such as Reflection or Isolation. Sometimes there are more than one standard in the class, such as LOADS. You may exit and reenter the current calibration sequence between measurement of groups. That is, if a group requires multiple standards, if you exit before all standards in the group are complete, then the data thus far measured for that group is lost and the standard label will not be underlined. If you leave the cal menu structure by pressing a function which displays another menu, press **CAL**, **RESUME CAL SEQUENCE**. The last cal menu for which data is available will be displayed.

Measurement Calibration

Time Low Pass Frequencies

In Time Domain, Time Low Pass mode, set the STOP frequency and number of points. Then press **SET FREQ. (LOW PASS)** and proceed with measurement calibration. Refer to the chapter titled, “Introduction to Time Domain” for a description of the frequency range requirements.

Step 1. Select a Calibration Kit

Press **CAL 1 <kit name>** or **CAL 2 <kit name>** to select the appropriate calibration kit, depending upon the category of calibration standards to be used. The accuracy enhancement algorithms use mathematical models of the standards to find the error coefficients. These models, and the specific names of the standards used in the calibration of a particular test port connector, are part of the calibration kit definition. Before starting the calibration procedure, be sure that the correct calibration kit for the test port connector type, the types of standards to be used, and frequency range is in 8510 memory.

The following descriptions assume use of a standard Agilent 7-mm or 3.5-mm calibration kit. Most calibration kits contains similar types of standards for a particular cal type so the names for any particular standards may be similar.

Refer to the instruction manual for the calibration kit in use to find the labels assigned to each class and each standard for the connector type of your test set. A complete calibration kit will contain a tape or disc file which defines the standards used in the kit. This file can be loaded using the disc load feature.

Pressing either the **CAL 1** or the **CAL 2** softkey brings the accuracy enhancement error model selection menu, known as the Cal Type menu onto the LCD/CRT display.

What is a “Class” and what is a “Standard?”

A standard is an individual calibration device, like a 3.5 mm female short. A class would be all the shorts. All the opens would be a different class.

Step 2. Select the Type of Cal You Need

Select the type of calibration you wish to perform:

- **RESPONSE RESPONSE & ISOL'N**
- **S₁₁ 1-PORT**
- **S₂₂ 1-PORT**
- **ONE-PATH 2-PORT**
- **FULL 2-PORT**
- **TRL 2-PORT**

Each of these calibration types is useful under a different set of circumstances. Figure 8-2 shows the errors corrected by each type of calibration, and the equivalent S-parameter error model.

Choices from the Cal Type menu branch to procedures involving connection and measurement of calibration standards.

What a Response Calibration Provides

The Response error model provides signal path frequency response error correction for the selected parameter. This model may be adequate for transmission measurements of well matched, low loss devices and for some reflection measurements where vector normalization of magnitude and phase frequency response errors provides sufficient measurement accuracy.

What a Response and Isolation Calibration Provides

The Response and Isolation error model adds correction of the leakage term, either directivity for reflection measurements, or crosstalk for transmission measurements. This model is appropriate for transmission measurements of well matched, high loss devices and for reflection measurements where mismatch is not a large factor.

What a 1-Port Calibration Provides

The 1-Port error model provides directivity, source match, and reflection signal path frequency response vector error correction for reflection measurements. This model is best applied to high accuracy reflection measurements of one-port devices.

What a Full 2-Port Calibration Provides

The error model used for Full 2-Port and TRL 2-Port provides full directivity, isolation, source match, load match, and frequency response vector error correction for transmission and reflection measurements of two-port devices on S-Parameter test sets. This model provides best magnitude and phase measurement accuracy for two-port devices but requires measurement of all four S-parameters of the two-port device. Both Full 2-Port and TRL 2-Port use the same error model and the same accuracy enhancement mathematics. The difference is in the standards used and the measurements made to quantify the error terms. (TRL requires fewer standards.)

8510 Measurement Specifications and Calibration

8510 measurement specifications are determined using either the 1-Port model for one-port devices, or either of the 2-Port models when measuring two-port devices.

Non-Insertable Devices

Multiple 2-Port calibrations can be used to calibrate the system when measuring “noninsertable” devices. This procedure is described later under “Transmission Measurements.”

Measurement Calibration

RESPONSE	Selected signal path frequency response.	
RESPONSE & ISOLATION	Selected signal path frequency response and leakage.	
S ₁₁ 1-PORT	S ₁₁ Directivity, Source Match, Frequency Response.	
S ₂₂ 1-PORT	S ₂₂ Directivity, Source Match, Frequency Response.	All error terms with respect to PORT 2.
ONE-PATH 2-PORT (Reflection/Transmission Test Sets)	S ₁₁ , S ₂₁ , S ₁₂ , S ₂₂ Directivity, Source Match, Frequency Response, Load Match, Isolation.	All error terms with respect to PORT 1, FORWARD 2-Port model.
FULL 2-PORT (S-Parameter Test Sets)	S ₁₁ , S ₂₁ , S ₁₂ , S ₂₂ Directivity, Source Match, Frequency Response, Load Match, Isolation.	
TRL 2-PORT (S-Parameter Test Sets)	S ₁₁ , S ₂₁ , S ₁₂ , S ₂₂ Directivity, Source Match, Frequency Response, Load Match, Isolation.	Same as Full 2-Port
When you select one of these cal types, the appropriate standard selection menu appears.		

Figure 8-2. Cal Type Selections

8-8 Calibrating for System Measurements

Step 3. Measure all Required Standards

Connecting Standards

To measure a calibration standard, select an appropriate standard from the list (such as OPEN or SHORT), connect the standard, and press the key. If there is a single standard assigned to that label, measurement of the standard begins and the message **WAIT-MEASURING CAL STANDARD** appears while the standard is being measured. *Do not press any front panel key while this message is displayed unless it is your intent to stop the measurement process.* When the standard has been measured, the standard name will be underlined to indicate measurement is complete.

Important If the standard label (shown on the LCD/CRT) includes an **M** (male), or an **F** (female), *the reference is to the sex of the test port connector, not the sex of the calibration standard.* This only occurs in sexed test port connectors such as type-N.

For example: You see a standard labeled **SHORT (F)** on the screen. You should connect a male short to the *type-N female test port* and then press the **SHORT (F)** softkey.

When You Are Finished Connecting Standards

When you measure all standards required for the selected cal type, press the **DONE** or **SAVE** key at the bottom of the menu.

Note If the calibration is not complete, such as in the case where the standards thus far measured are not specified over the full frequency range being swept, then pressing **DONE** or **SAVE** causes the message **ADDITIONAL STANDARDS NEEDED** to appear. Measure the additional standards needed then press **DONE** or **SAVE** again.

After you press **DONE** or **SAVE**, and all standards necessary for the cal type have been measured, the Cal Set Selection menu appears. Press one of the softkeys to select Cal Set 1, 2, 3, 4, 5, 6, 7, or 8 to contain the error coefficients for the calibration. The error coefficients are computed and stored then correction is turned on and corrected data is displayed.

If you are using averaging. If averaging is On when the standard selection key is pressed, then the correct number of measurements needed to provide fully averaged data are automatically taken. For Ramp sweeps, this means that $n+1$ sweeps, where n is the current averaging factor, are taken. For Step, Single Point, or Frequency List, each data point is averaged $n+1$ times.

Standards Required for a Response Calibration

The Response Cal menu for the 7 mm connector is shown in Figure 8-3. The response measurement calibration sequence requires a single standard:

- A **SHORT** or **OPEN** for reflection measurements.
- Or a **THRU** for transmission measurements.

Measurement Calibration

The standard is used to determine the frequency response of the current signal path. If more than one standard is measured, the last standard pressed is used to compute the frequency response correction term.

FREQUENCY RESPONSE
CAL MENU (7mm)

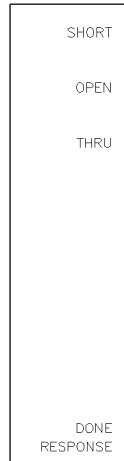

Figure 8-3. Response Cal Menu

Standards Required for a S_{11} 1-Port Calibration

The S_{11} 1-Port calibration sequence requires a minimum of three standards, an OPEN, a SHORT, and at least one standard from the LOADS menu.

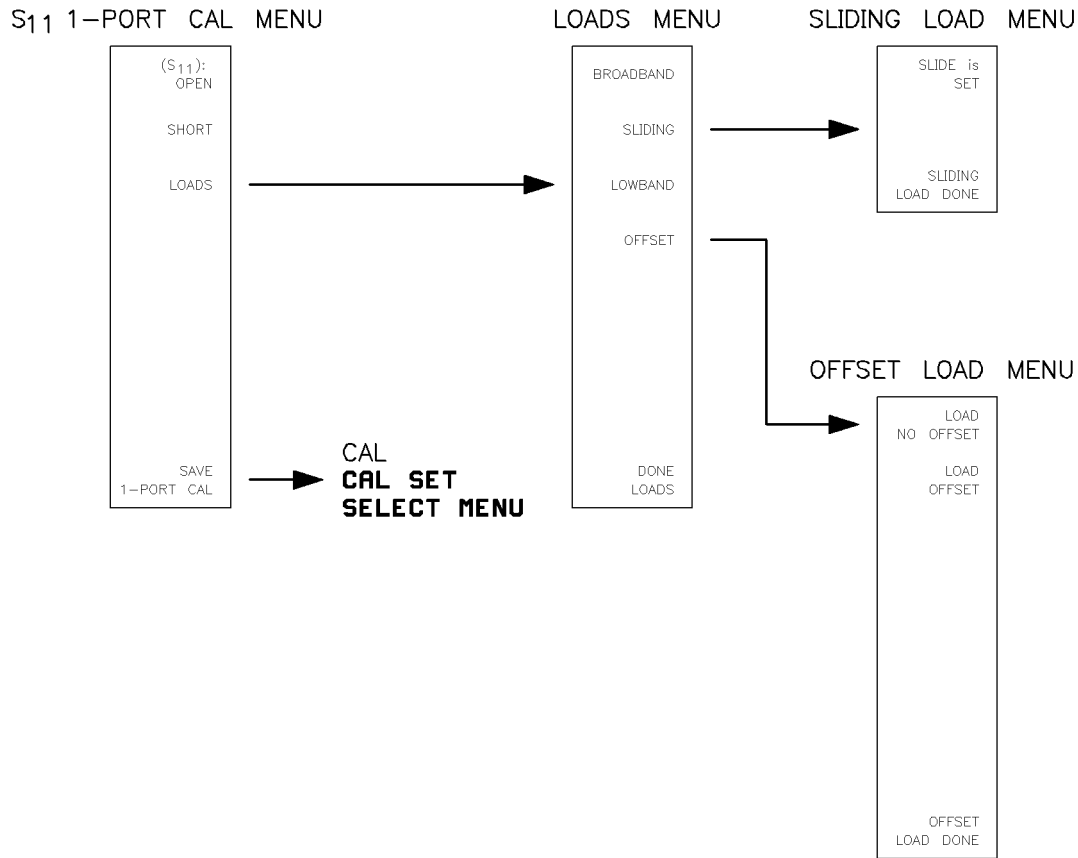

Figure 8-4. S₁₁ 1-Port Cal Menu

For some calibration kits, the standards on the Loads menu are specified as to the frequency range they cover:

- LOWBAND** A lowband load is specified from the lowest frequency up to 2.001 GHz for 7 mm and 3.001 GHz for 3.5 mm standards.
- SLIDING** A sliding load is specified from 1.999 GHz up to the highest frequency. Use the Sliding Load menu to control measurement by pressing **SLIDE is SET** to make at least 5 measurements with the load element in different positions, then press **SLIDING LOAD DONE**.
- BROADBAND** A broadband load is specified over the full frequency range.
- OFFSET** an offset standard can be used instead of the Sliding Load when the appropriate transmission line is available. It is specified from 2.0 GHz up to the highest frequency. When you select this standard, measure the Broadband load connected directly to the port and press **LOAD NO OFFSET**, then connect the transmission line and the load to the port and press **LOAD OFFSET**. When both measurements have been made, press **OFFSET LOAD DONE**.

Thus, for sweeps that cross 2 GHz, calibration using such a kit requires that you use both the **LOWBAND** and **SLIDING** or **OFFSET** loads, or the **BROADBAND** load.

Measurement Calibration

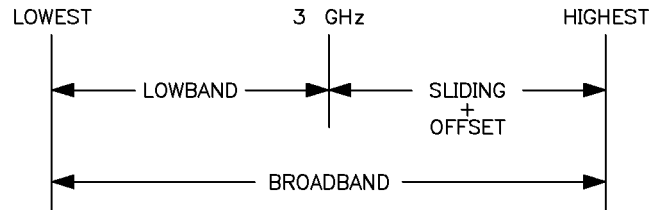

Figure 8-5. LOADS Frequency Ranges

Standards Required for a Full 2-Port Calibration

Selecting **FULL 2-PORT** brings the Full 2-Port measurement calibration menu onto the display. This cal requires you to do the following:

1. If you intend on performing a reflection measurement, select **REFLECTION** then measure at least three standards, just as in the 1-Port sequence. Connect and measure the appropriate S_{11} standards at Port 1 and the appropriate S_{22} standards at Port 2, then press **REFLECT'N DONE**.
2. If you intend on performing a transmission measurement, select **TRANSMISSION**, connect the thru, then press the four standard selection softkeys to measure transmission frequency response and the terminating impedance.
3. Now select **ISOLATION**, and connect appropriate Z_0 terminations (fixed loads) at Port 1 and Port 2. For best isolation cal, select a large averaging factor (at least 128) by pressing:

RESPONSE **(MENU)** **AVERAGING ON/restart** **(256)** **(x1)** **(CAL)** **RESUME CAL SEQUENCE**

Then select the measurement.

If a large averaging factor is not used, the error may be greater than if the isolation cal were not performed. To skip isolation cal, press **OMIT ISOLATION**. When the measurement is complete, press **ISOLATION DONE**.

4. When all necessary standards on the list have been measured, press the bottom softkey labeled **DONE** or **SAVE**. You may measure the standards in any order. Until you press **DONE** or **SAVE**, you may remeasure any standard on the currently displayed list and the last measurement on any particular standard will be used.

Measurement order is not important. Reflection, Transmission, and Isolation steps can be done in any sequence, and you can measure standards in any order. Parameter selection is automatic during these sequences.

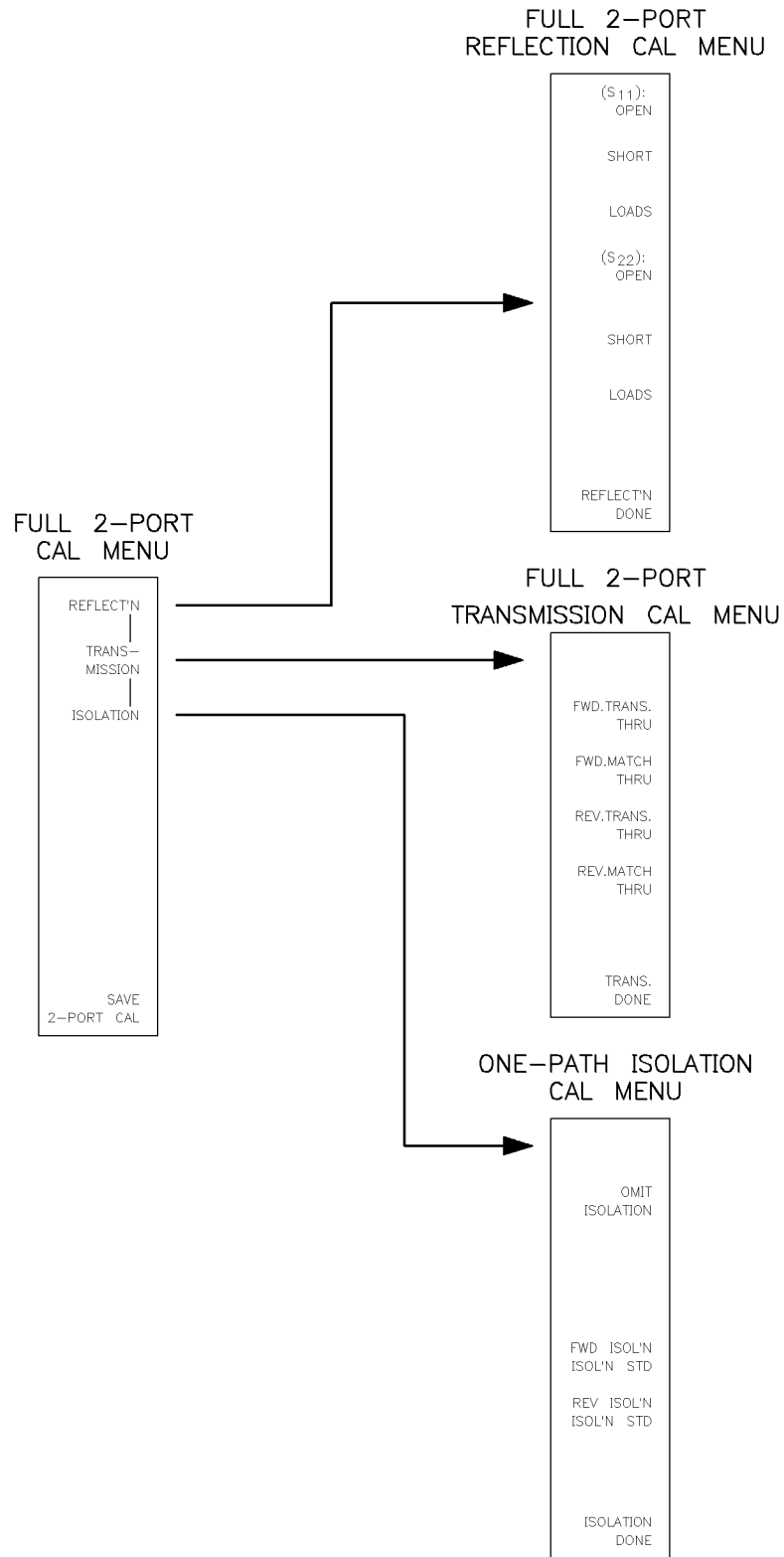

Figure 8-6. Full 2-Port Reflection, Transmission, and Isolation Cal Menus

Measurement Calibration

Standards Required for a TRL 2-Port Calibration

Selecting **TRL 2-PORT** brings the TRL 2-Port Cal menu onto the display. This menu, for the 7 mm precision calibration kit, is shown in Figure 8-7. This calibration technique uses the thru connection, a short circuit at Port 1 and Port 2, loads for isolation, and a certain length of precision transmission line. Parameter selection is automatic during these sequences.

TRL 2-PORT CAL MENU

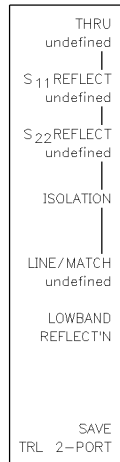

Figure 8-7. TRL 2-Port Cal Menu

Although this calibration can be performed over the entire frequency range of the connector type, for best accuracy a separate Lowband Reflection calibration is recommended (but not required) below 2 GHz. The standards for the keys **THRU THRU**, **S₁₁ REFLECT SHORT**, **S₂₂ REFLECT SHORT**, **ISOLATION**, and **LINE 2-18 LINE** must be measured first. Afterwards, if the Start frequency is below 2 GHz, press **LOWBAND REFLECT'N**.

Step 4. Saving the Cal Set to Memory

Calibration Save Registers and Storage Capacity

At this point, the Cal Set Selection menu and the message **SELECT CALIBRATION SET** are displayed. Error terms are computed and stored in the internal calibration set storage register you specify at the end of the measurement calibration sequence. Up to eight calibration sets can be saved. However, only four calibration sets can be stored if they are 801 point Full 2-Port or TRL 2-Port calibration sets. That is, if you perform four 801 point Full 2-Port or TRL 2-Port calibrations and store the results in Cal Sets 1, 2, 3, and 4, the internal storage will be full even though calibration set numbers 5 through 8 are empty.

How to tell if a register already has a Cal Set in it.

If the calibration memory register has an * next to it, there is already a calibration stored in it. If you select that register anyway, the old calibration set will be deleted and replaced by the new one.

What to do if all registers are full

If internal storage is already full, a calibration set must be deleted using `DELETE CAL SET` before calibration can proceed. Selecting a calibration set to receive error coefficient data automatically replaces the old data with the new data.

Cal Set Limited Instrument State

The calibration set saves critical settings that were in effect when the calibration was saved. Changing any of these settings once calibration is turned On can invalidate the calibration, or cause calibration to turn Off automatically.

- Parameter
- Frequency Range
- Number of Points
- Source Power
- Sweep Time
- Power Slope
- Sweep Mode and values
- Trim Sweep values

S-Parameter Test Set (Two-Path) Calibration Error Models

All calibration error models may be used with S-Parameter test sets:

Frequency Response: S_{11} , S_{21} , S_{12} , or S_{22}

Frequency Response & Isolation: S_{11} , S_{21} , S_{12} , or S_{22}

1-Port: S_{11} or S_{22}

Full 2-Port: S_{11} , S_{12} , S_{21} , and S_{22}

TRL 2-Port: S_{11} , S_{12} , S_{21} , and S_{22}

The following pages contain example measurement calibration sequences using each of these models. The standard labels are those used for the standard 7 mm or 3.5 mm calibration kits.

Frequency Response Calibrations

This calibration error model provides vector error correction for the selected parameter signal path frequency response using a single standard (usually a thru for transmission; a short or an open for reflection).

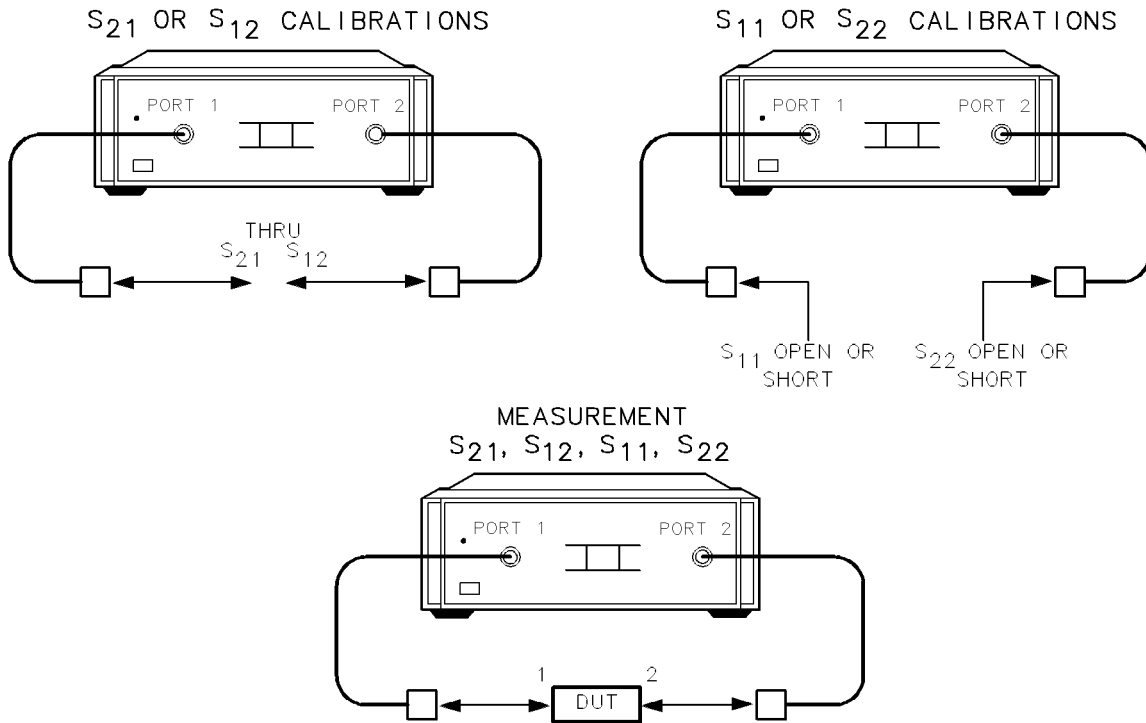

Figure 8-8. S-Parameter Test Set Frequency Response Calibrations

One-Port Device: S₁₁ Frequency Response Calibration

1. Press **S11** **CAL** **CAL 1** **CALIBRATE: RESPONSE**.
2. At Port 1, connect either a short or a shielded open circuit.
3. When the trace is correct, press **SHORT** or **OPEN**. Data is measured.
4. Press **DONE RESPONSE**, then select a Cal Set (1 through 8). Error coefficients are computed and stored; Cal menu is displayed with **CORRECTION ON**. A Corrected trace is displayed.
5. Connect the test device, and measure S₁₁.

Two-Port Device: S_{11} Frequency Response Calibration

1. Press **S11** **CAL** **CAL 1** **CALIBRATE: RESPONSE**.
2. At Port 1, connect either a short circuit or a shielded open circuit.
3. When the trace is correct, press **SHORT** or **OPEN**. (S_{11} data is measured.)
4. Press **DONE RESPONSE**, then select **CAL SET 1**. (Error coefficient is computed and stored; Cal menu is displayed with **CORRECTION ON**.)
5. Corrected S_{11} data is displayed.
6. Connect the test device.
7. Measure S_{11} .

Two-Port Device: S_{21} Frequency Response Calibration

1. Press **S21** **CAL** **CAL 1** **CALIBRATE: RESPONSE**.
2. Connect Port 1 to Port 2 Thru.
3. When the trace is correct, press **THRU**. (S_{21} thru data is measured.)
4. Press **DONE RESPONSE** then select **CAL SET 2**. (Error coefficient is computed and stored; Cal menu is displayed with **CORRECTION ON**.)
5. Corrected S_{21} data is displayed.
6. Connect the test device.
7. Measure S_{21} .

Two-Port Device: S_{12} Frequency Response Calibration

1. Press **S12** **CAL** **CAL 1** **CALIBRATE: RESPONSE**.
2. When the trace is correct, press **THRU**. (S_{12} thru data is measured.)
3. Press **DONE RESPONSE**, then select **CAL SET 3**. (Error coefficient is computed and stored; Cal menu is displayed with **CORRECTION ON**.)
4. Corrected S_{12} data is displayed.
5. Connect the test device.
6. Measure S_{12} .

Measurement Calibration

Two-Port Device: S_{22} Frequency Response Calibration

1. Press **(S22)** **CAL 1**, **CALIBRATE: RESPONSE**.
2. At Port 2, connect either a short circuit or a shielded open circuit.
3. When the trace is correct, press **OPEN** or **SHORT**. (S_{22} data is measured.)
4. Press **DONE RESPONSE**, then select **CAL SET 4**. (Error coefficient is computed and stored; Cal menu is displayed with **CORRECTION ON**.)
5. Corrected S_{22} data is displayed.
6. Connect the test device.
7. Measure S_{22} .

Response and Isolation Calibration

To extend the measurement dynamic range in the presence of noise, such as for a high loss two-port device, use the Response and Isolation calibration instead of the simpler Response calibration. While this calibration improves the effective directivity for reflection measurements, it is best applied to transmission measurements.

Two-Port Device: Transmission Frequency Response and Isolation Calibration

1. Connect Port 1 to Port 2 Thru.
2. Press **(S21)** **CAL 1** **CALIBRATE: RESPONSE & ISOL'N** then **RESPONSE**.
3. When the trace is correct, press **THRU**. S_{21} thru data is measured.
4. Connect a load at Port 1 and a load at Port 2.
5. When the trace is correct, press **ISOL'N STD**. S_{21} noise floor is measured.
6. Press **SAVE RESP&ISOL**, then select **CAL SET 2**.
7. Corrected S_{21} data is displayed.
8. Connect the test device, and measure S_{21} .

1-Port Calibration

This calibration error model provides the best accuracy for measurement of a one-port device, providing full vector error correction for directivity, source match, and reflection signal path frequency response. The procedure uses three standards, usually a shielded open circuit, a short circuit, and a load.

During the S_{11} 1-Port calibration, all standards are connected at Port 1 (the point at which the test device input port will be connected).

During the S_{22} 1-Port calibration, all standards are connected at Port 2.

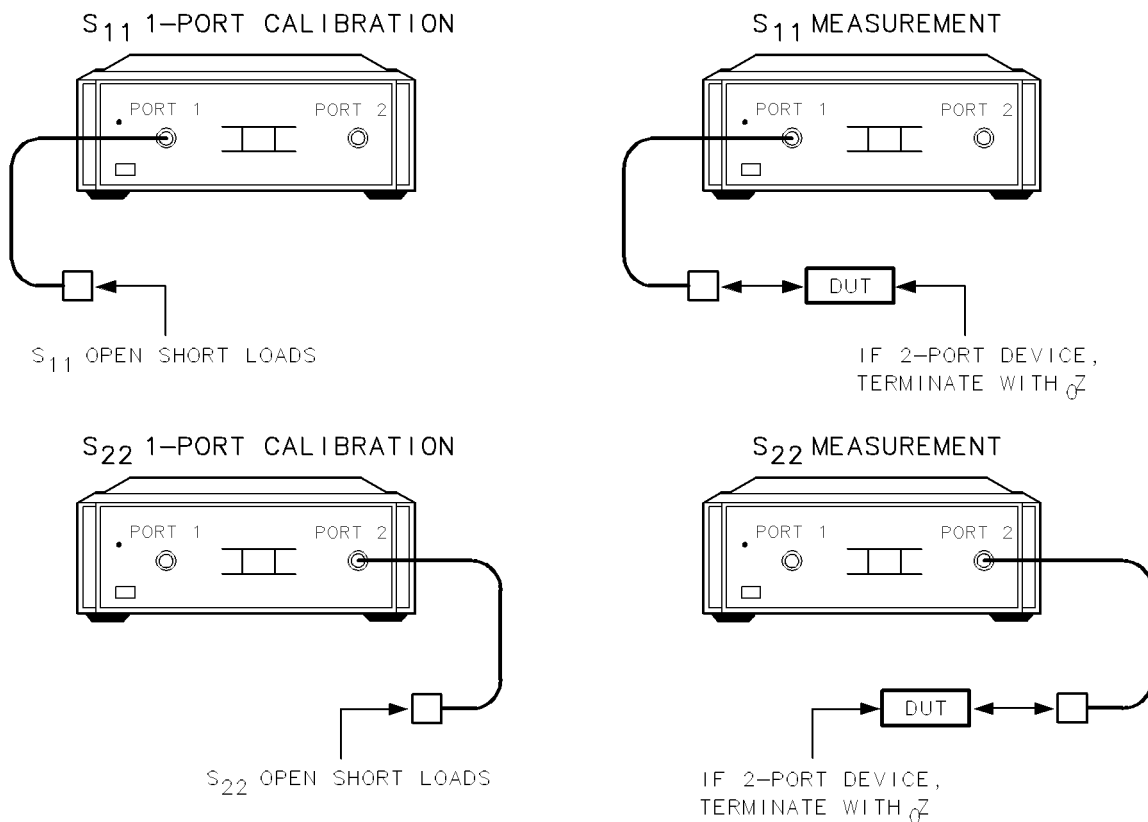

Figure 8-9. S-Parameter Test Set 1-Port Calibrations

One-Port Device: S_{11} 1-Port Correction

1. Press **(S11)** **(CAL)** **CAL 1**, **CALIBRATE: S₁₁ 1-PORT**.
2. At Port 1, connect a shielded open circuit.
3. When the trace is correct, press **(S₁₁): OPEN**. Open circuit data is measured.
4. At Port 1, connect a short circuit.
5. When the trace is correct, press **(S₁₁): SHORT**. Short circuit data is measured.
6. Press **(S₁₁): LOADS** to present the Loads menu. If the frequency sweep crosses 2 GHz, then both the **LOWBAND** and **SLIDING** loads, or the **BROADBAND** load must be used.

Measurement Calibration

7. At Port 1, connect a fixed load.
8. When the trace is correct, press **LOWBAND**. Load data is measured.
9. At Port 1, connect a sliding load.
10. Move sliding element to the first index mark; then, when the trace is correct, press **SLIDE IS SET**. Load data is measured.
11. Repeat 5 to 8 times, each time moving the sliding element to the next index mark, then pressing **SLIDE IS SET**.
12. Press **SLIDING LOAD DONE**.
13. Press **DONE LOADS**. If the message **ADDITIONAL STANDARDS NEEDED** appears, then the loads were not specified for the current frequency range (for example, only the **LOWBAND** load was used for a sweep that crossed 2 GHz).
14. Press **SAVE 1-PORT CAL**, then select a **CAL SET 1**. (Error coefficients are computed and stored; Cal menu is displayed with **CORRECTION ON**.)
15. Corrected S_{11} trace is displayed.
16. Connect the test device.
17. Measure S_{11} .

One-Port Device: S_{22} 1-Port Correction

To use the S_{22} 1-Port calibration, proceed as follows, connecting the standards at Port 2.

1. Press **(S22) CAL 1 CALIBRATE: S_{22} 1-PORT**.
2. Perform the S_{22} 1-Port calibration procedure, use **(S_{22}): OPEN**, **SHORT**, and **LOADS**, connect all standards at Port 2, press **SAVE 1-PORT CAL**, then store the error coefficients using another **CAL SET 1** through 8.
3. Connect the test device.
4. Measure S_{22} .

Two-Port Device: Combining Error Models

To obtain greater accuracy in measurement of a one-port device, perform the S_{11} 1-Port and S_{22} 1-Port calibration sequences described above instead of the S_{11} and S_{22} frequency response calibrations. This procedure shows a calibration sequence for measurement of a two-port device using a combination of S_{21} and S_{12} frequency response and S_{11} and S_{22} 1-Port error models.

If the insertion loss of the device is large, then the Response and Isolation cal should be used instead of the response cal for S_{21} and S_{12} .

1. Press **(S11) (CAL) CAL 1 CALIBRATE S_{11} 1-PORT**.
2. Perform the S_{11} 1-PORT calibration sequence, already described; use **S_{11} OPEN**, **SHORT**, and **LOADS**, connect standards at Port 1.

3. Press **SAVE 1-PORT CAL** then select **CAL SET 1**.
4. Corrected S_{11} data is displayed.
5. Connect Port 1 to Port 2 Thru.
6. Press **S21** **CAL 1** **CALIBRATE: RESPONSE**.
7. When the trace is correct, press **THRU**. S_{21} thru data is measured.
8. Press **DONE RESPONSE** then select **CAL SET 2**.
9. Corrected S_{21} data is displayed.
10. Press **S12** **CAL 1** **CALIBRATE: RESPONSE**.
11. When the trace is correct, press **THRU**. S_{12} thru data is measured.
12. Press **DONE RESPONSE** then select **CAL SET 3**.
13. Corrected S_{12} data is displayed.
14. Press **S22** **CAL 1** **CALIBRATE: S22 1-PORT**.
15. Perform the S_{22} 1-PORT calibration sequence; use **S22 OPEN**, **SHORT**, and **LOADS**, connect standards at Port 2.
16. Press **SAVE 1-PORT CAL** then select **CAL SET 4**.
17. Corrected S_{22} data is displayed.
18. Connect the test device.
19. Measure any parameter.

This procedure is less accurate than the 2-Port model because source and load match correction is not included in the transmission measurement. However, the procedure is slightly faster to perform and since all four parameters do not need to be measured, the measurement of each parameter is faster.

Full 2-Port Calibration

The Full 2-Port measurement calibration procedure can be used only with the S-parameter test sets. This calibration error model provides the best accuracy when measuring two-port devices. Four standards are used, usually a shielded open circuit, a short circuit, a load or loads, and a thru. This model provides full error correction of directivity, source match, reflection and transmission signal path frequency response, load match, and isolation for S_{11} , S_{21} , S_{12} , and S_{22} .

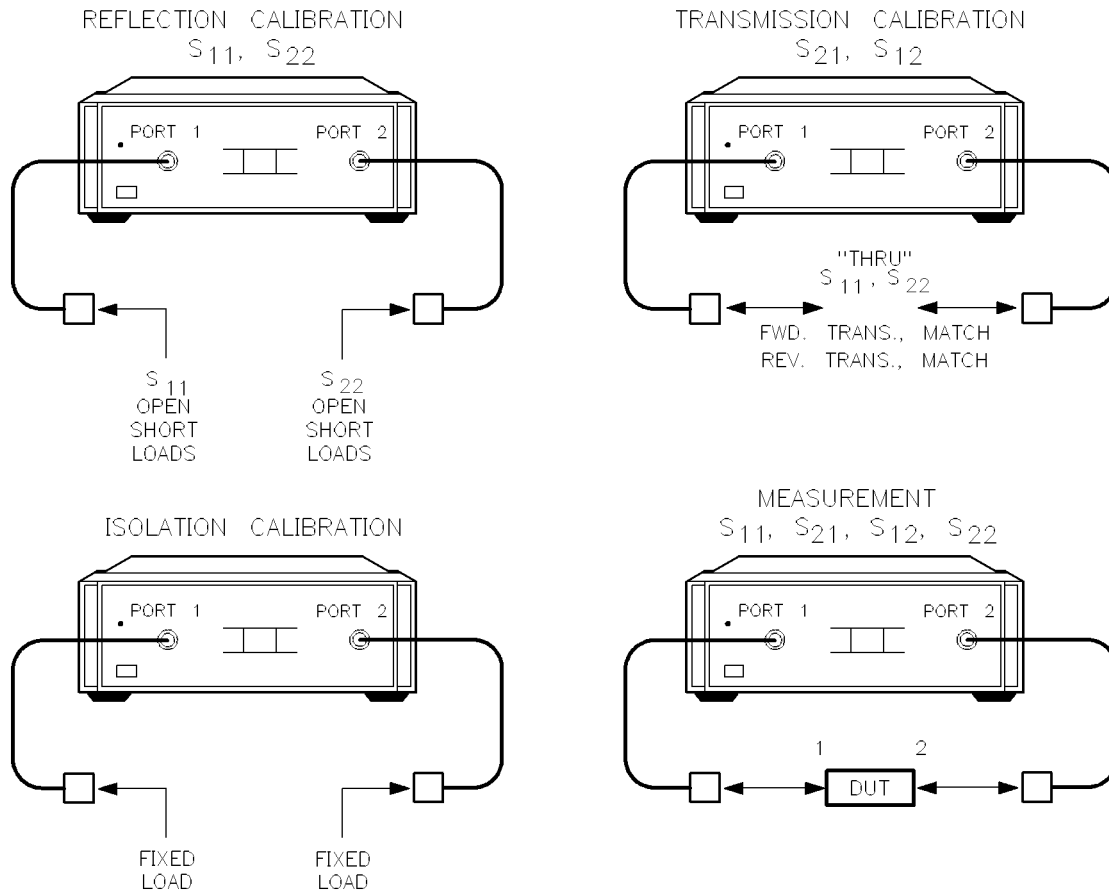

Figure 8-10. S-Parameter Test Set Full 2-Port Calibration

Two-Port Device: Full 2-Port Calibration Sequence (S-Parameter Test Sets)

1. Press **CAL** **CAL 1**, **CALIBRATE: FULL 2-PORT** then **REFLECT'N**.
2. Proceed as for the S_{11} 1-PORT calibration sequence; connect standards at Port 1, use (S_{11}): **OPEN**, **SHORT**, and **LOADS**, do not press **REFLECT'N DONE**.
3. Proceed as for the S_{22} 1-PORT calibration sequence; connect standards at Port 2, use (S_{22}): **OPEN**, **SHORT**, and **LOADS**.
4. Press **REFLECT'N DONE**. Reflection error coefficients are computed.
5. Press **TRANSMISSION**.

6. Connect Port 1 to Port 2 Thru.
7. When the trace is correct, press **FWD. TRANS. THRU**. S_{21} frequency response is measured.
8. Press **FWD. MATCH THRU**. S_{21} load match is measured.
9. Press **REV. TRANS. THRU**. S_{12} frequency response is measured.
10. Press **REV. MATCH THRU**. S_{12} load match is measured.
11. Press **TRANS. DONE**. Transmission error coefficients are stored.
12. Press **ISOLATION**.
13. Connect a load at Port 1 and a load at Port 2.
14. When the trace is correct, press **FWD. ISOL'N ISOL'N STD**. S_{21} noise floor is measured.
15. Press **REV. ISOL'N ISOL'N STD**. S_{12} noise floor is measured.
16. Press **ISOLATION DONE**. Forward and reverse isolation error coefficients are stored.
17. Press **SAVE 2-PORT CAL**, then select a Cal Set (1 through) to save the error coefficients. Error coefficients are computed and stored; Cal menu is displayed with **CORRECTION ON**.
18. Corrected trace is displayed.
19. Connect test device.
20. Press any PARAMETER key, **(S11)**, **(S21)**, **(S12)**, or **(S22)**, to display corrected data for that parameter.

TRL 2-Port Calibration

Not all calibration kits contain the precision transmission line required to accomplish the LINE part of the TRL 2-Port calibration.

Two-Port Device: TRL 2-Port Calibration Sequence

1. Press **CAL** **CAL 1**, **CALIBRATE: TRL 2-PORT**.
2. Connect Port 1 to Port 2 Thru.
3. When the trace is correct, press **THRU THRU**. Several parameters are measured.
4. At Port 1, connect a short circuit.
5. When the trace is correct, press **S₁₁ REFLECT SHORT**. Data is measured.
6. At Port 2, connect a short circuit.
7. When the trace is correct, press **S₂₂ REFLECT SHORT**. Data is measured.
8. Press **ISOLATION**.
9. Connect a load at Port 1 and a load at Port 2.
10. When the trace is correct, press **FWD. ISOL'N ISOL'N STD**. S_{21} noise floor is measured.
11. Press **REV. ISOL'N ISOL'N STD**. S_{12} noise floor is measured.
12. Press **ISOLATION DONE**. Forward and reverse isolation error coefficients are stored.
13. Connect the precision transmission line between Port 1 and Port 2.
14. When the trace is correct, press **LINE 2-18 LINE**. Several parameters are measured.
15. If the Start frequency is below 2 GHz, press **LOWBAND REFLECT'N**, then proceed to the Reflection part of the Full 2-Port calibration procedure.
16. Press **SAVE TRL 2-PORT**, then select a Cal Set (1 through) to save the error coefficients. Error coefficients are computed and stored; Cal menu is displayed with **CORRECTION ON**.
17. Corrected trace is displayed.
18. Connect test device.
19. Press any PARAMETER key, **S₁₁**, **S₂₁**, **S₁₂**, or **S₂₂**, to display corrected data for that parameter.

R/T Test Set (One-Path) Calibration Error Models

You may choose S_{11} Response, S_{21} Response, S_{11} 1-Port, or One-Path 2-Port calibration error models. Reverse calibration may also be performed (S_{12} and S_{22} response and S_{22} 1-Port), but in this case, the standards (open, short, and load) are still connected to port 1. During measurement, you must use care to physically reverse the test device and select the appropriate parameter (S_{11} or S_{22}).

Use procedures similar to those listed for the S-Parameter test set but only connect standards to Port 1.

Response and 1-Port

The reflection/transmission test set cannot produce real-time error corrected measurements using the One-Path 2-Port error model because the device under test must be manually reversed for each measurement. For this reason, the technique of combining the response and 1-Port error models described above is usually the quickest way to measure a two-port device on a reflection/transmission test set where source and load match effects are not an important factor in the accuracy of the measurement.

One-Path 2-Port

The One-Path 2-Port calibration error model is designed specially for the reflection/transmission test set. It provides vector error correction of directivity, source match, reflection and transmission signal path frequency response, load match, and isolation errors for S_{11} , S_{21} , S_{12} , and S_{22} . This procedure is similar to the Full 2-Port calibration procedure described previously for S-parameter test sets, except that all calibration takes place with respect to Port 1, and the device under test (and possibly the adapters if used) must be manually reversed in the process of measuring any S-parameter.

This manual reversal makes it impossible to obtain fully error-corrected data in real time. Instead, pressing the softkey labeled **PRESS TO CONTINUE** controls a measurement process that includes operator prompts to connect the test device for forward and reverse measurements, finishing with the corrected data for the selected parameter displayed and ready for data output. Pressing another parameter key either displays the corrected data for the new parameter choice immediately, or restarts the measurement process.

When load and source match effects are not major error contributors in the measurement, or when you wish to view the real time response of the device under test and are not concerned with absolute measurement accuracy, use a combination of S_{11} 1-Port and S_{22} 1-Port reflection calibrations with S_{21} and S_{12} frequency response transmission calibrations, instead of the One-Path 2-Port sequence.

Averaging may be used during measurement calibration. If you use Ramp sweep during the device measurement, averaging cannot be used with correct results due to the need to repeatedly manually reverse the device. In Step sweep, averaging can be used with the usual benefit.

Measurement Calibration

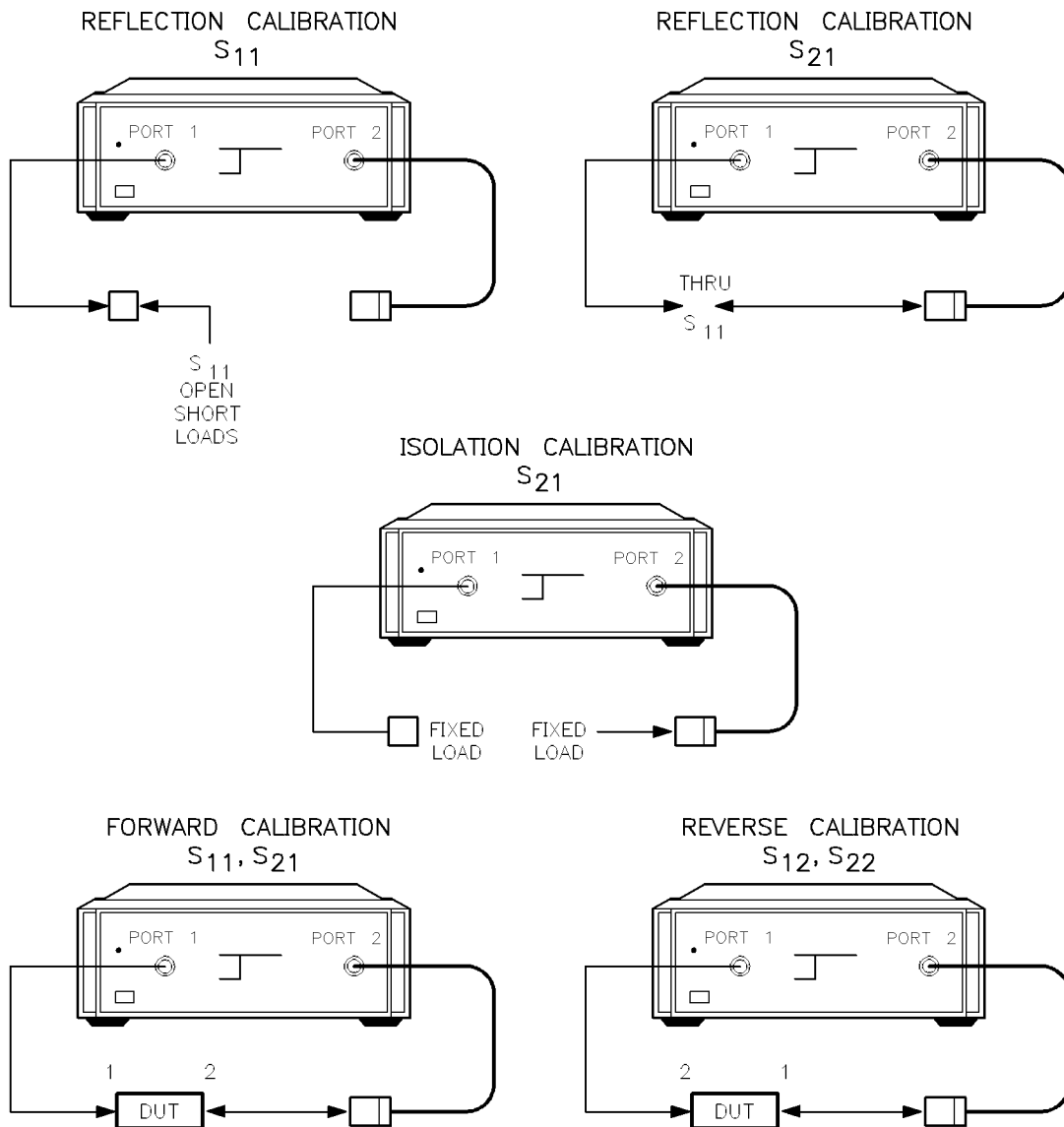

Figure 8-11. Reflection/Transmission Test Set One-Path 2-Port Calibration

After you complete the calibration procedure:

1. Connect test device.
2. Select parameter for display by pressing **(S11)**, **(S21)**, **(S12)**, or **(S22)**.
3. Follow instructions to connect the test device for forward measurement, then **PRESS TO CONTINUE**.
4. Follow instructions to connect the test device for reverse measurement, then **PRESS TO CONTINUE**.
5. Observe the corrected trace.
6. To measure another parameter, press the key for the desired PARAMETER.

7. To measure the next test device, connect the test device, then **PRESS TO CONTINUE** or **MEASUREMENT (RESTART)**.

Storing Calibration Data to Disc

Cal data can be stored on disc, recalled, checked for validity, then used if acceptable results are obtained. To store a calibration set on disc:

Press **(DISC) STORE CAL 1-8 CAL SET n CAL SET FILE n**.

To transfer the calibration set from tape to internal memory:

Press **(DISC) LOAD CAL SET 1-8 CAL SET n CAL SET FILE n**.

Since many files of a single calibration set can be stored on disc, it is convenient to save a calibration set and use it at another time rather than recalibrate the system. However, if the mechanical characteristics (such as connectors and cables) of the test setup has changed, the calibration set may no longer apply. To test the validity of the calibration set, measure a simple known device such as a calibration standard and verify that the response is correct.

Principles and Care of Calibration Standards

This section explains the special care required by calibration standards, principles behind their use, and common problems associated with them.

Calibration Standards Require Careful Handling

For best accuracy and repeatability, use great care in handling and storing the calibration devices. Their performance and accuracy depend on very precise mechanical tolerances, sometimes on the order of a few ten thousandth of an inch. Therefore, the standards must be handled and stored more carefully than ordinary devices.

Proper Inspection, Cleaning, and Connection

Inspect and clean the connectors using the methods recommended in the calibration kit manuals. Use gauges on the test port connectors, standards, cables, and the test device to verify that the mating plane dimensions of all connectors are within the allowable tolerances. To minimize repeatability errors, use an appropriate torque wrench when tightening or loosening connections. Detailed information on calibration standards, and on recommended techniques of using them appears in the calibration kit manuals.

Principles of Operation

In simple terms, accuracy enhancement is accomplished by measuring known standards. The measured response is compared to the predicted response, then error terms are derived from the magnitude and phase difference between the measured response and the predicted response. The predicted response is determined by using a complex mathematical model which predicts the magnitude and phase response of the calibration standard over its entire frequency range. Thus, the accuracy improvement which can be expected is directly related

Measurement Calibration

to how well the models predict the response of the standard. The model for each standard is specified in a data file on the disc supplied with the calibration kits.

Examples of “perfect” standards are shown in the assumptions made for the fixed and sliding loads used in reflection calibration. The device impedance is assumed to be exactly the system characteristic impedance, Z_0 , usually 50 ohms.

Quality of the Standards Affects Accuracy

The quality of the load used for calibration determines the effective directivity for reflection measurements. A high quality fixed load exhibits the lowest repeatable return loss. The quality of the sliding load is determined by the return loss of the connector and the transmission line between the connector and the sliding element.

Standard Models Differ Depending on Connector Type

Standard models differ according to connector type. For example, the short circuit in the Agilent 7-mm calibration kit is modeled as a perfect zero ohm termination, having a reflection coefficient of $1\angle\pm 180^\circ$ positioned at the reference plane. The short circuit in the Agilent 3.5-mm calibration kit is modeled as a perfect short displaced about 1 cm from the reference plane.

Specifications for the shielded open circuits add a reactive phase shift to the modeled response characteristic. In order to model the typical non-linear phase shift, the shielded open circuit is assumed to exhibit a phase shift with frequency that can be approximated using the equation

$$C_{\text{total}} = C_0 + C_1 * F + C_2 * F^2 + C_3 * F^3$$

where C_0 is the DC capacitance, $C_1 * F$ is the capacitance times frequency, $C_2 * F^2$ is the capacitance times frequency squared, and $C_3 * F^3$ is the capacitance times frequency cubed. The shielded open circuits in the 3.5 mm calibration kit use a center pin extender, so the models for these devices also include a linear phase shift component to account for the offset from the reference plane.

Specifications, Modifying a Cal Kit

The specifications contained on the calibration kit data file are nominal values based on typical expected responses of the standards. If you wish to substitute your own standards, or change the models for the standards supplied in the calibration kit, you may use the `MODIFY CAL KIT` sequence.

Common Problems

Common calibration problems which can be traced to standards are:

- Non-repeatable contact due to wear, dirt, grease, or other contaminants on the contacting surfaces or other accessible parts of the standard. Assure that the standard is properly cleaned. Make sure the connector is dry.
- Connector damage due to connecting the standard to a connector with mechanical defects or out-of-spec tolerances. Use the connector gage on both the test port and the standard prior to measurement calibration.
- Poor contact due to improper alignment or torquing practice. Use the correct connection technique and the proper torque wrench for each connection.

- Using cal standards whose response does not match the constants used in the 8510 internal calibration kit definitions. Refer to the calibration kit manuals for electrical and mechanical specifications.

Verifying Calibration Data

Immediately following calibration, and at intervals during the measurement process, it is recommended that you measure a standard device with known responses. This is to verify that the system characteristics have not changed, thus making the current calibration error coefficients invalid. Measuring a device from the calibration kit used for measurement calibration will allow you to determine that the system is making repeatable measurements. The measured response of a calibration standard will be exactly the modeled response if the connection is repeatable.

To determine measurement accuracy, however, it is necessary to measure an independent standard with known responses, such as the attenuators or air lines in the 8510 verification kit, or a standard you produce that is representative of the devices you are testing. If standards-quality data for the device is available, it can be compared with your measurement results to determine accuracy. If the data is outside acceptable limits and good technique was used during the calibration, then the system characteristics have changed, thus making the current calibration error coefficients invalid. Standards-quality measurement data is supplied with the Agilent verification devices.

Adjusting Trim Sweep

The Trim Sweep Adjustment procedure applies only to measurements made in the Ramp sweep mode. It is considered a part of the measurement calibration process because it provides most improvement when it is accomplished for each particular frequency range. The **TRIM SWEEP** setting is saved as part of the instrument state when you press **SAVE** **INSTRUMENT STATE n**, and as part of the limited instrument state saved when you save a calibration set. It is set to zero by **FACTORY PRESET**.

The **TRIM SWEEP** function performs a different purpose for Agilent 834x and 835x sources. For Agilent 8340 sources used in the Ramp Sweep mode, it is used to adjust the end frequency at the band switch points to minimize the frequency difference between the end frequency of one band and the start frequency of the next higher band. Trim Sweep is not used in the Step Sweep mode. For 835x sources, Trim Sweep is adjusted to provide the best frequency accuracy.

Measurement Calibration

Using Agilent 834x Series Sources

If you are using the ramp sweep mode, set trim sweep to provide minimum frequency difference between the step and ramp modes as follows:

1. Press **RECALL** **MORE** **FACTORY**. Select **S21** for display.
2. Connect measurement Port 1 to measurement Port 2 (thru connection).
3. Set the START/STOP or CENTER/SPAN controls to sweep the frequency range of interest.
4. Select STIMULUS **MENU** **STEP**. When the sweep is complete, press **DISPLAY DATA** **→** **MEMORY** **MATH (/)**. When the next sweep is complete, the trace should be a flat line at zero degrees.
5. Press STIMULUS **MENU** **RAMP**. The displayed trace may exhibit a sharp phase transition at the band switch points. Sharp transitions indicate the need to adjust **TRIM SWEEP**.
6. Press **CAL** **MORE** **TRIM SWEEP**. Then use the knob to adjust the phase trace for minimum phase change at the band switch points. When the best (flattest) phase trace is achieved, press **SAVE** **INSTRUMENT STATE n** to save this setting. Now proceed with the appropriate measurement calibration.

Using 835x Series Sources

Set **TRIM SWEEP** to provide best frequency accuracy as follows:

1. Press **RECALL** **MORE** **FACTORY PRESET**. Select **S21** **PHASE** for display.
2. Connect measurement Port 1 to measurement Port 2 (thru connection).
3. Set the START/STOP or CENTER/SPAN controls to sweep the frequency range of interest.
4. Set Averaging Factor to 128. Select **DELAY** **MARKER**, then move the marker to the center frequency. Read Delay value = Delay₁.

This step measures a reference value, Delay₁, which represents the electrical length difference between the reference and test signal paths. If the signal paths are exactly equal, the result will be zero seconds.

5. Press **DISPLAY** **DATA** **→** **MEMORY** **MATH (/)**. The trace should be a flat line at zero degrees.
6. Connect an electrical delay of known length between measurement Port 1 and measurement Port 2. The device should have a low loss and exhibit a precisely known electrical delay, as does the air line in an Agilent verification kit.

Any air line may be used but you must know its exact electrical delay.

7. Select **PHASE**. Enter the electrical delay of the air line by pressing **RESPONSE** **MENU** **ELECTRICAL DELAY**, and then entering the specified electrical delay of the device. The phase transitions should disappear, leaving a phase trace with some slope. Any residual slope indicates a need to adjust **TRIM SWEEP**.

8. Press **CAL** **MORE** **TRIM SWEEP**. Then use the knob to adjust for flat phase trace (endpoints). Record this value as TRIM SWEEP₁.
9. Read the delay value at the center frequency = DELAY₂.
10. Compute:

$$\text{Trim Sweep}_2 = \left(\frac{\text{Delay}_1 + \text{Delay}_2}{\text{Delay}_2} \right) \text{Trim Sweep}_1$$
11. Set Trim Sweep to TRIM SWEEP₂. This step compensates for imbalance in the test set signal paths. The phase trace may not be flat.
12. Press **SAVE** **INSTRUMENT STATE n** to save this setting. Now proceed with the appropriate measurement calibration.

Modifying a Calibration Kit

The Modify Cal Kit menu structure allows you to create or change the mathematical model and label for each calibration standard and to specify how the standards are used in the calibration process. The following paragraphs provide an overview of the sequence used to modify a calibration kit definition. Detailed descriptions of each part of the calibration kit definition are included in the *Agilent 8510 Keyword Dictionary*. The calibration kit definition for each calibration kit is provided as a Cal Kit data file on the tape supplied with each calibration kit, and it is listed in the Standard Definitions and Standard Class Assignments tables in the calibration kit manual.

You may explore the Modify Cal Kit menus without actually changing any part of the definition stored in 8510 memory. Each time **CAL 1**, **CAL 2**, **MODIFY 1**, or **MODIFY 2** is pressed, the selected calibration it defines is loaded from non-volatile memory to active memory. Definitions and assignments that are not actually changed remain the same. The kit definition is not re-stored into non-volatile memory until **KIT DONE (MODIFIED)** is pressed. So, if you are simply examining the contents, exit the menu structure by pressing **CAL**, then **CAL 1** or **CAL 2**, not by pressing **KIT DONE (MODIFIED)**.

Before entering the Modify Cal Kit menu structure, make certain that you have a copy of the calibration kit definition you are about to modify. If necessary, copy the calibration kit definition to disc using the **STORE**, **CAL KIT 1-2** operation on the disc menu.

Now locate the calibration kit documentation tables found in the calibration kit manuals and use them as worksheets to specify the characteristics of each standard, the label for the standard, assign each standard to one or more classes, to specify the label for each class, and finally to specify the new label for the modified calibration kit.

To modify the calibration kit definition, first press **CAL** **MORE**, then either **MODIFY 1 <cal kit label>** or **MODIFY 2 <cal kit label>**.

Press **SELECT STANDARD**, then select the device definition to be modified by entering a Standard Number (a numeric between 1 and 22) then pressing **x1**. The Standard Type menu is displayed with the current standard type underlined. Press the appropriate standard type key, then enter the appropriate characteristics of the standard using the Standard Definitions

Measurement Calibration

and the Specify Offset menus. Label the standard using LABEL STD key and the Title menu. This label will appear on the cal Standard Selection menu during the calibration procedure.

Repeat this sequence for each new or modified standard in the calibration kit. Standard definitions not changed during this process are included in the modified calibration kit with their pre-existing values.

Press SPECIFY CLASS, then use the Specify Class menus to assign appropriate standards to each of the classes required for the calibration type. When you select a class, the current standard numbers assigned to that class are listed in the title area. Enter one, or a sequence of, standard number followed by for each standard to be used in the class, then press CLASS DONE (SPEC'D).

Now press LABEL CLASS and name each new or changed standard class. This label will appear on the appropriate cal menus when there is more than one standard assigned to the class.

Repeat this procedure for each of the Standard Classes required for the calibration procedure.

Next, press LABEL KIT and name the modified calibration kit. This name will appear on the Cal menu. Finally, press KIT DONE (MODIFIED) to store the new kit in place of the selected kit.

Notice that to indicate that the kit definition has been modified, if any standard definition is changed, the kit name is automatically changed by replacing the last character of the calibration kit label with the * symbol. This is why the LABEL KIT operation is the last to be performed.

Modifying a Calibration Set

You can modify a calibration set in the following ways:

- Reducing the number of points measured after a calibration set has been created.
- Defining a frequency subset. You can create a new set by zooming in on a frequency subset of the original calibration set frequency range.
- Changing the calibration type. Create a new set by changing the calibration type. You can change an active two-port calibration (full, one-path, or TRL) set to a one-port calibration set.
- Modifying a Cal Set with connector compensation. Create a new calibration set by applying connector compensation to an active one-port or two-port calibration set.

Reducing the Number of Points After Calibration

This type of modification allows the number of points to be reduced without affecting the calibration or the endpoints of the current frequency range. Thus, after a calibration using 801 points, either 401, 201, 101, or 51 points can be selected. This is accomplished by skipping over alternate frequency points. For example, when the number of points is reduced from 801 to 401, only every other point is measured.

Effects in Step Sweep Mode

This feature is designed for use in step sweep applications where it is necessary or desirable to calibrate using the maximum number of points, but portions of the test can be performed using less frequency resolution. In these instances, test time can be reduced by selecting a fewer number of points, resulting in a shorter time for the frequency sweep.

In the example shown in Figure 8-12, measurement calibration is performed using step sweep and 801 points, then the number of points is reduced to 51. The time required to update the trace is decreased by a factor of about 16. When necessary, the original number of points can be selected by either changing the **NUMBER OF POINTS** selection, or, by recalling the original calibration set.

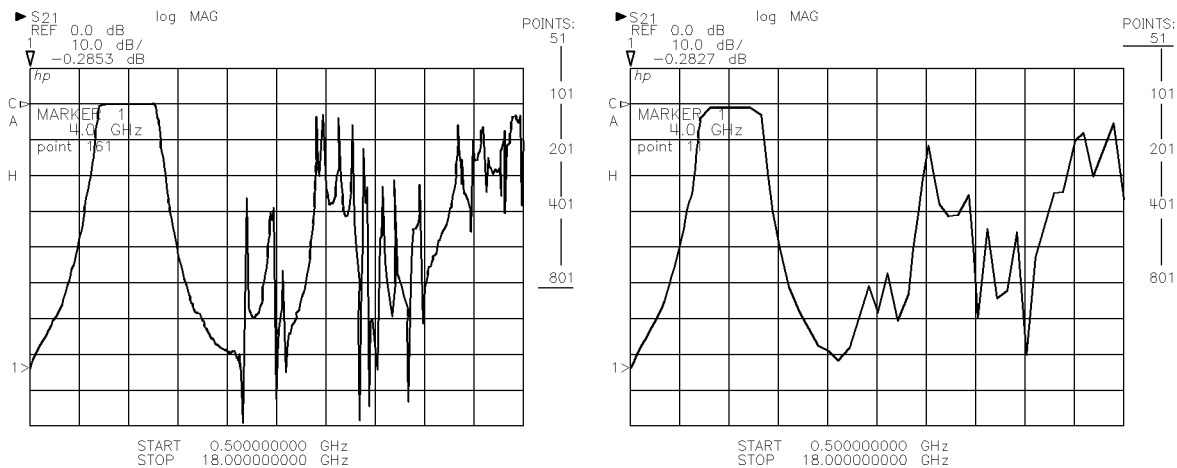

Figure 8-12. Reduced Number of Points After Calibration

If a number of points greater than the original calibration is selected, a caution message is displayed and correction is turned off. Note that when the number of points is reduced from the original calibration, Time Low Pass cannot be selected.

Effects in Ramp Sweep Mode

The number of points may also be reduced after calibration in the ramp sweep mode, however, in order for the data to remain valid, the sweep time cannot change. This limits the usefulness of this feature for ramp sweeps.

After Factory Preset, the analyzer automatically selects a faster sweep for 51 points than for 801 points. If the network analyzer sweep time is changed after calibration, a caution is displayed in order to alert the user to examine the resulting data carefully. The dynamics of the measurement process change and the accuracy of the data may be affected. For best results, press **STIMULUS** **MENU** then **SWEEP TIME**, and set the sweep time to 200 ms (milliseconds) prior to measurement calibration. Now the sweep time will remain constant regardless of the **NUMBER OF POINTS** selection.

Measurement Calibration

Defining a Frequency Subset

After calibration in either ramp, step, or frequency list sweep mode, a subset of the current frequency range can be selected by choosing new Start/Stop or Center/Span frequencies and a new calibration set. This provides a very useful “frequency zoom” function by allowing the user to arbitrarily select a subset of the current frequency sweep. This results in less time for the frequency sweep because fewer points are measured. The frequency subset menu is shown in Figure 8-13

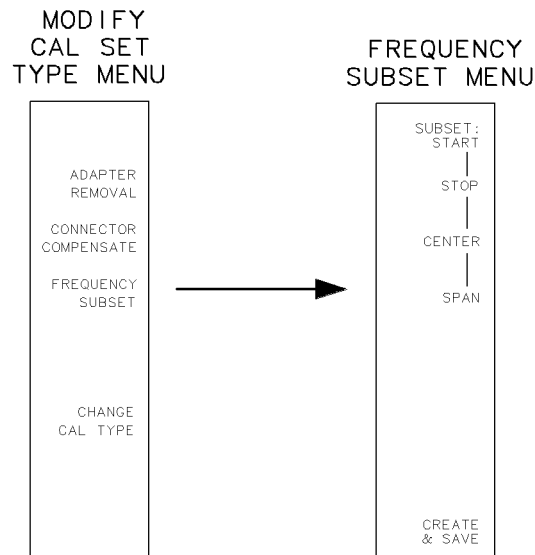

.modcal

Figure 8-13. Modify Cal Set, Frequency Subset Menu

Create and Save the Frequency Subset

To define a frequency subset, turn correction ON, then press **CAL**, **MORE**, **MODIFY CAL SET**, and **FREQUENCY SUBSET**.

As shown in Figure 8-14, markers appear on the trace to show you the current Start/Stop or Center/Span of the frequency subset. Position these markers by pressing the **SUBSET: START**, **STOP**, **CENTER** or **SPAN** softkeys and using the knob, step keys, or numeric entry. Now press **CREATE & SAVE**, then select a new calibration set (different from the existing calibration set, or else the existing calibration set is lost). The appropriate error coefficients from the existing calibration set are transferred to the new calibration set, a frequency list is created and stored, the frequency list sweep mode is selected, and corrected data for the subset is displayed.

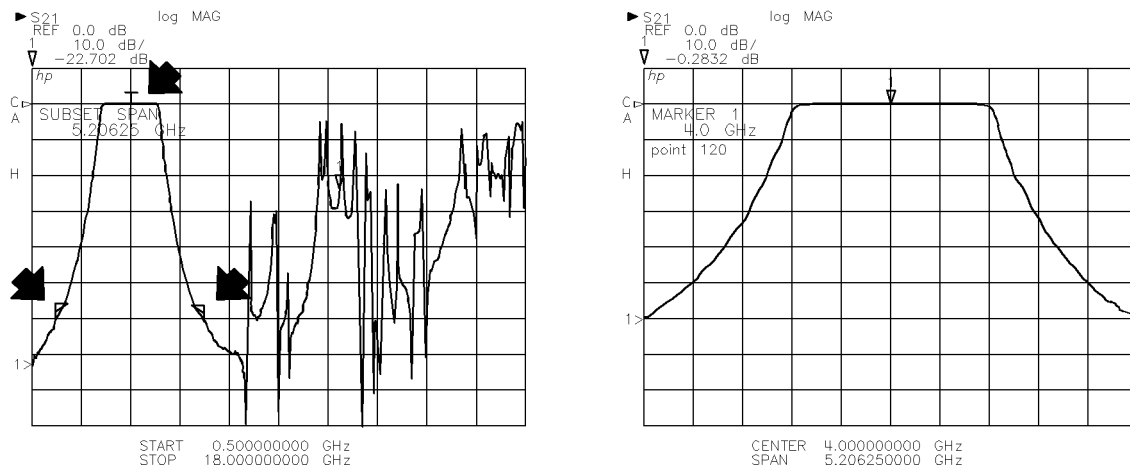

Figure 8-14. Defining a Frequency Subset

Note that the frequencies in the subset may be examined by selecting **STIMULUS** **MENU**, **MORE**, **EDIT LIST**. If this list is edited, correction is turned Off. To return to the original frequency sweep, recall the original calibration set. To select the frequency subset sweep, recall the new calibration set.

Effects in Ramp Sweep Mode. A frequency subset created from a ramp sweep may be less accurate than the original ramp sweep due to the fact that the original calibration took place in ramp sweep while the new frequency subset is measured in the frequency list sweep mode. Since the ramp sweep is not phaselocked at each frequency point, the slight potential frequency difference at each point between the ramp and frequency list sweeps may cause the displayed data to change.

To reduce this effect, prior to calibration in the ramp sweep mode, set the sweep time to 200 ms or greater, and perform the trim sweep (8350-series and 8340-series sources only) adjustment. The trim sweep adjustment, along with the slower sweep time, minimizes the frequency difference at each point and improve accuracy of the data. For Agilent 8360-series sources, put the analyzer in the **SYSTEM BUS 'LOCAL'** mode and press the source front-panel keys **USER CAL** **FullUsr Cal** (use the Front-Panel Emulator Program for those sources with no front-panel keys).

Measurement Calibration

Changing the Calibration Type

There are applications when it is not possible to use a 2-port calibration for measurement because automatic switching of the test set cannot be tolerated when the device is connected. For these applications, it is typical to perform a 1-port calibration for the reflection parameters and response or response and isolation calibrations for the transmission parameters.

However, in a subset of these applications, automatic switching can be tolerated during calibration, but not during measurement. For these applications, you can create new calibration sets from an active two-port calibration set, using the Change Cal Type feature. The two-port set can be a full two-port, a one-path two-port, or a TRL two-port calibration set.

2-PORT to: S₁₁ 1-PORT creates an S₁₁ 1-port calibration from the currently active 2-port calibration set.

2-PORT to: S₂₂ 1-PORT creates an S₂₂ 1-port calibration from the currently active 2-port calibration set. Use the following key sequence to create the new calibration set.

1. **CAL** **MORE**
2. **MODIFY CAL SET**
3. **CHANGE CAL TYPE**
4. **2-PORT to: S₁₁ 1-PORT**
5. **CHANGE & SAVE**
6. **CAL SET n** (select a new cal set, different from the existing cal set. If the same cal set is used, its original contents are overwritten.)

Modifying a Cal Set with Connector Compensation

Connector compensation is a feature that provides for compensation of the discontinuity found at the interface between the test port and a connector. The connector here, although mechanically compatible, is not the same as the connector used for the calibration. There are several connector families that have the same characteristic impedance, but use a different geometry. Examples of such pairs include:

3.5 mm / 2.92 mm

3.5 mm / SMA

SMA / 2.92 mm

2.4 mm / 1.85 mm

The interface discontinuity is modeled as a lumped, shunt-susceptance at the test port reference plane. The susceptance is generated from a capacitance model of the form:

$$C=C_0 + C_1 \times F + C_2 \times F^2 + C_3 \times F^3$$

where F is the frequency. The coefficients are provided in the default Cal Kits for a number of typically used connector-pair combinations. To add models for other connector types, or to change the coefficients for the pairs already defined in a Cal Kit, use the “Modifying a

Calibration Kit” procedure on the previous pages. Note that the definitions in the default Cal Kits are additions to the Standard Class ADAPTER, and are Standards of type “OPEN.”

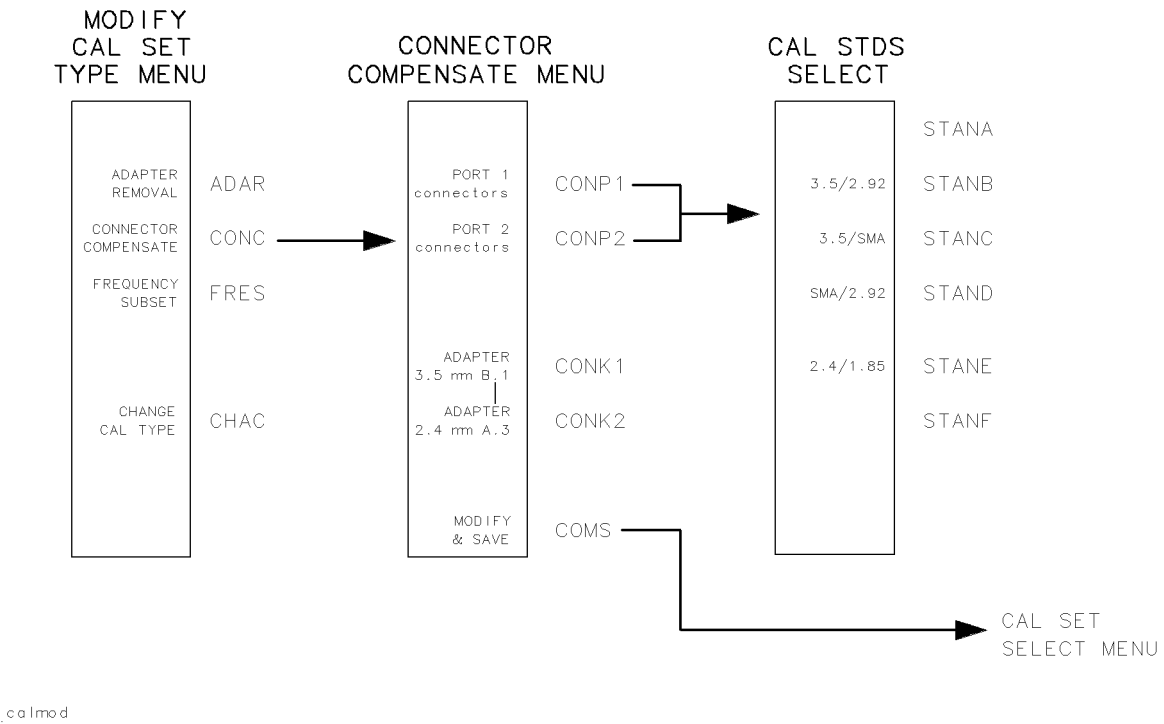

Figure 8-15. Connector Compensation Menu Keys

Measurement Calibration

Using Connector Compensation

1. Press **CAL**, then press **MORE**.
2. Press **MODIFY CAL SET**, then press **CONNECTOR COMPENSATE**.

Note Connector compensation requires that the active Cal Set be a 1-Port or 2-Port calibration. If a Cal Set of any other type is selected, the message **ACTIVE CALSET WRONG TYPE** appears.

3. Choose the connector pair at either **PORT 1 connectors** or **PORT 2 connectors** to apply connector compensation.
4. From the standards menu, choose the correct pair of connectors.

Note If the connector pairs listed do not include the connector pairs you are using, return to the prior menu to choose the alternate Cal Kit before repeating the procedure.

If the connector pairs you are using are not listed in either Cal Kit 1 or Cal Kit 2, then you need to modify the calibration kit. Use the **MODIFY 1** or **MODIFY 2** functions to enter an appropriate set of coefficients. Refer to the previous section, “Modifying a Calibration Kit.”

After selecting a connector pair, the previous menu re-appears with the selected Port selection underlined.

5. To apply connector compensation to the other port, repeat Step 3 for the other port.
6. Press **COMPENSATE & SAVE** to compute the modified Cal Set.
7. Select a Cal Set to store the modified calibration terms.

Other than the changes to the error coefficients, all other properties of the Cal Set remain unchanged.

Note that you do not need to overwrite the original (uncompensated) Cal Set. You may also compare the *compensated* Cal Set with the *uncompensated* Cal Set and view the effect of compensation.

Transmission Measurements

Introduction

This part of the Agilent 8510 network analyzer system manual explains how to make the following transmission measurements on a typical two-port device:

- Insertion loss and gain
- Insertion phase
- S-parameters
- Group delay
- Electrical delay
- Deviation from ideal phase

Also included is the description of the procedure used to measure noninsertable devices. These measurements are described individually, each with separate setup, measurement calibration, and measurement sequences.

Measuring Two-Port Devices

When planning a test sequence for a two-port device, there are two important factors to consider: the type of two-port device you are going to measure and the type of test set in your system.

There are generally three kinds of two-port devices (Figure 9-1), as listed below:

Insertable	The port 1 connector type will mate with the port 2 connector type (port 2 is of the same family but is of opposite sex to that of port 1).
Reversible	Reversible devices use the same connector type on both port 1 and port 2 (port 2 is the same family and same sex as port 1).
Transitional	Transitional devices use connectors from different families on port 1 and port 2.

Both reversible and transitional devices are called “noninsertable.” Only hermaphroditic (sexless) connectors, like the standard 7 mm, are both insertable and reversible.

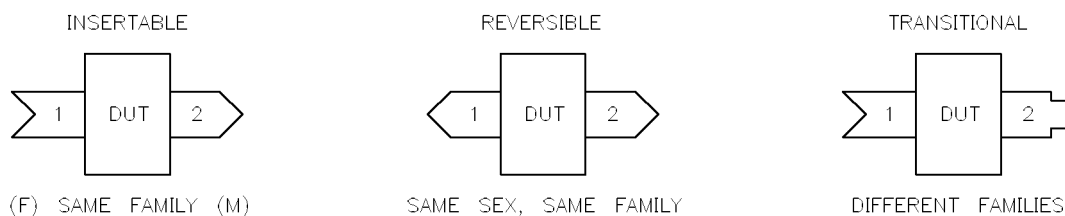

Figure 9-1. Two-Port Device Types

Note

The main problem when attempting fully calibrated measurements on a noninsertable device is that the test set Port 1 and Port 2 connectors cannot be mated in order to make the thru connection. Conventional calibration strategies for measurement of noninsertables include either switching the sex of one port of the test set to make the thru, or inserting an appropriate adapter of the same connector types as the test device during the thru calibration, then ignoring the errors caused by changing the test set between calibration and measurement. A new technique for measurement of noninsertables is discussed later.

Using Test Sets

The two basic types of test sets are listed below:

S-parameter	Called two-path test sets because the stimulus can be switched to either port 1 or port 2, thus allowing both forward and reverse characteristics of the test device to be measured without manually reversing the test device.
Reflection/Transmission	Called one-path test sets because the stimulus can only be applied to port 1 and the test device must be physically reversed to measure its reverse parameters.

Each combination of device type and test set type calls for a slightly different measurement calibration and measurement sequence. For example, measurement of an insertable device using a two-path test set is the ideal case. Because the test device has connector types which can be mated on its port 1 and port 2, measurement calibration can be performed with the correct adapters in place, and since the test set can switch the stimulus between port 1 and port 2, all parameters can be measured without manually reversing the test device.

S-PARAMETER TEST SET

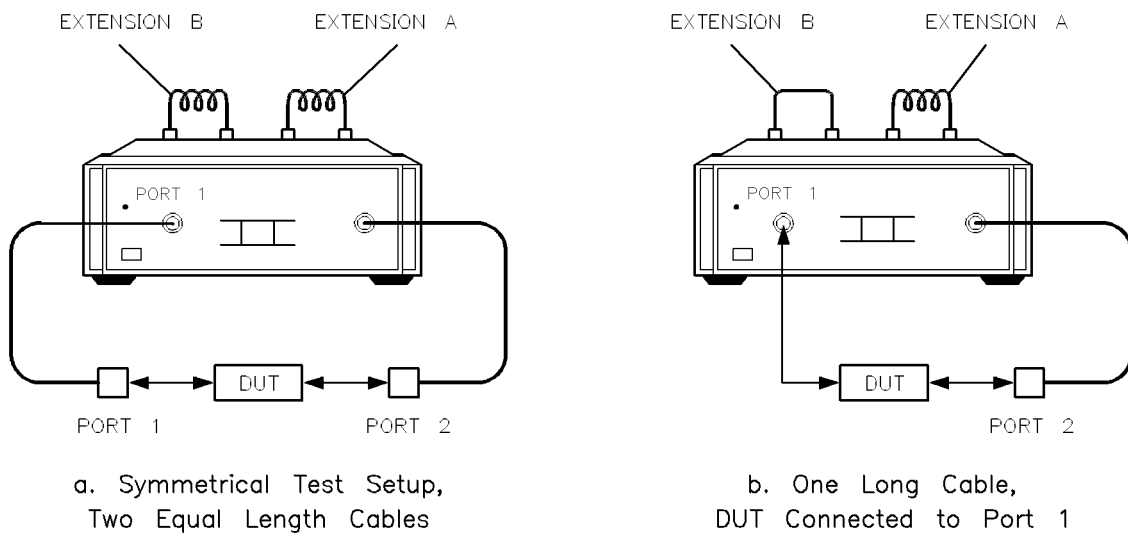

REFLECTION/TRANSMISSION TEST SET

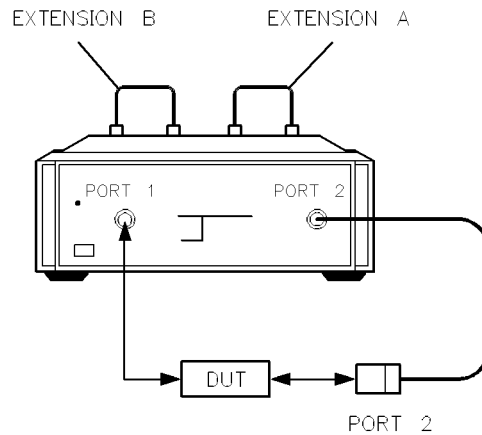

Figure 9-2. Transmission Test Setups

Setting Up for Transmission Tests

Figure 9-2 shows typical transmission test setups for S-parameter and reflection/transmission test sets.

Transmission Measurement Calibration Choices

There are four different calibration types available for transmission measurements:

- Response calibration
- Response and Isolation calibration
- One-Path 2-port calibration
- 2-Port calibration

These types differ in accuracy or in the type of errors they remove.

Setting up for Response Calibration

The RESPONSE calibration model uses a thru (connect Port 1 and Port 2 together at the point at which the test device will be connected) as the standard device. The RESPONSE model can be used for S_{21} forward transmission calibration and for S_{12} reverse transmission calibration. It can also be used for calibration with all user parameters.

Response and Isolation Calibration

The RESPONSE & ISOL'N calibration model uses a thru and an open transmission path to determine signal path frequency response and the crosstalk, or isolation. It provides an increase in dynamic range for transmission measurements by reducing the effects of leakage between the reference and test signal paths and averaging random noise. This model can be used for S_{21} forward transmission calibration and for S_{12} reverse transmission calibration. It can also be used for calibration with all user parameters.

One-Path 2-Port Calibration

This model provides fully corrected transmission and reflection measurements for a reflection/transmission test set. It uses a thru, a shielded open circuit, a short circuit, and loads to calibrate at Port 1. The operator follows instructions displayed on the LCD/CRT *to manually reverse the test device for measurement of the reverse parameters.*

Full 2-Port and TRL Calibrations

This model provides fully corrected transmission and reflection measurements with an S-parameter test set. The Full 2-Port typically uses a thru, a shielded open circuit, a short circuit, and loads to calibrate at Port 1 and Port 2. The TRL 2-Port technique uses a thru, shorts, isolation loads, and a precision transmission line. Multiple 2-Port calibrations are used in the procedure for measurement of noninsertable devices.

Measurement Calibration for Noninsertable Devices

The Modify Cal Set function under the Cal menu provides a means of obtaining exact calibration coefficients when measuring noninsertable devices. This technique requires calibration standards for both connector types and an adapter whose connectors match that of the device under test and whose electrical length is known within ± 90 degrees at each measured point over the selected frequency range. This technique is called Adapter Removal because after the procedure, the effects of the adapter used in the calibration are effectively removed. In order to accomplish the two calibrations as quickly as possible, measure the thru connection last when you perform the initial calibration. Leave the thru connected and measure it first in the subsequent calibration. Figure 9-3 illustrates the following procedure. The intent of the procedure is summarized below:

- Adapter A1, which mates with port 1 of the device, is installed on test set Port 1.
- Adapter A2, which mates with port 2 of the device is installed on Port 2 of the test set.
- The adapter A3, which has the same connectors as the device, is installed.
- Two Full 2-Port or TRL 2-Port calibrations are performed, the first at the connection between A1 and A3, and the second at the connection between A2 and A3, with the error coefficients for each cal stored in separate calibration sets.

9-4 Transmission Measurements

Making an Adapter Removal Measurement

1. Press **MODIFY CAL SET ADAPTER REMOVAL** and the Adapter Removal menu appears.
2. Press **CAL SET for PORT 1** and designate the calibration set for the first calibration (A3 connected to Port 2).
3. Press **CAL SET for PORT 2** and designate the calibration set for the second calibration (A3 connected to Port 1).
4. Press one of the **ADAPTER <kit name>** softkeys to select the Cal Kit which contains the definition of the adapter A3.
5. Press **MODIFY & SAVE** then select the calibration set to receive the processed cal coefficients.

The calibration set that results from combining the two calibration sets is computed and stored, then correction is turned on.

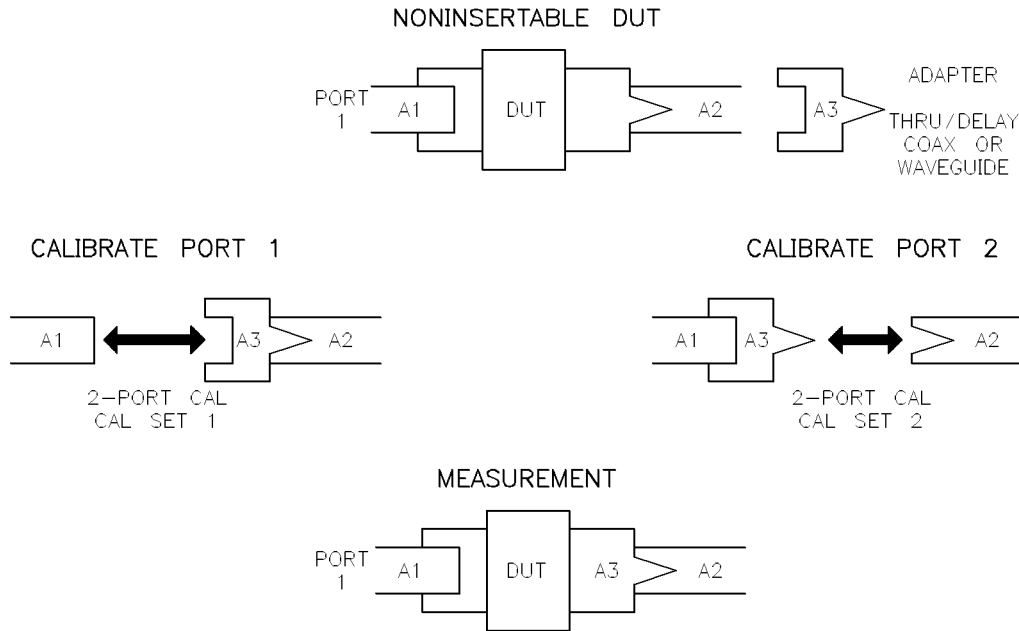

Figure 9-3. Adapter Removal Calibration Sequence

The resultant 2-Port calibration set contains error coefficients that accurately represent the characteristics of Port 1 and Port 2, as if A1 and A2 were actually connected together to measure forward and reverse frequency response and load match.

Further, as a check on the accuracy of the calibration, if you measure adapter A3, the measurement results will accurately represent the actual characteristics of the adapter. If not, then either the calibration was not performed properly or the adapter was not specified properly in the calibration kit definition. Unexpected phase transitions in the adapter measurement indicates that the adapter's electrical delay is not specified correctly.

Insertion Loss/Gain Measurement

This sequence lists the steps for a typical insertion loss or gain measurement.

1. Select start and stop frequency and display scale settings as desired.
2. Perform an appropriate measurement calibration.
3. Connect the DUT.
4. Select **LOG MAG**.
5. Press **MARKER** and read insertion loss (dB).

Measurement calibration sets the magnitude and phase ratio between the reference and test signal paths to zero with a thru connection. After connecting the test device, a negative measured value indicates insertion loss; a positive measured value indicates gain. Take care to choose signal levels to achieve maximum dynamic range.

Figure 9-4 shows a display of the magnitude response of a bandpass filter using the **LOG MAG** format. The measurement marker is positioned to the minimum insertion loss point using the sequence **MARKER MORE MARKER TO MAXIMUM**.

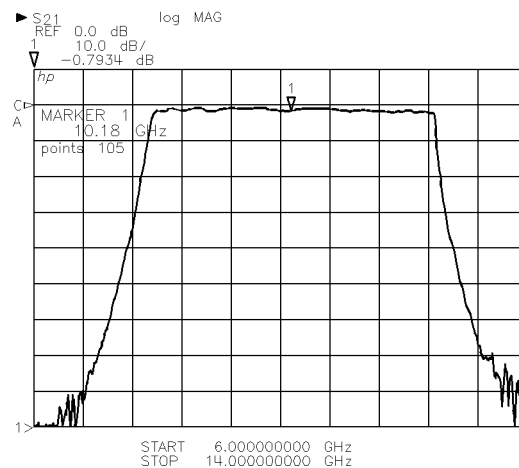

Figure 9-4. Typical Insertion Loss Display

Measuring 3 dB Frequencies

The insertion loss and gain measurement procedure can be extended to measure the 3 dB insertion loss points of the filter.

1. Press **MARKER** **MARKER 1** **MORE** **MARKER TO MAXIMUM**.
2. Press **TARGET VALUE** **-3** **x1**.
3. Press **MARKER** or **PRIOR MENU** **Δ** **MODE MENU** **Δ** **REF = 1**.
4. **MARKER 2** **MORE** **MARKER** **to** **TARGET**.
5. **MARKER** **MARKER 1** **MORE** **SEARCH LEFT**.

Markers 1 and 2 are now set to the 3 dB points of the filter. To read the entire 3 dB bandwidth frequency span:

6. **MARKER** **MARKER 2**.

The frequency span between the 3 dB points will be shown in the Active Entry area.

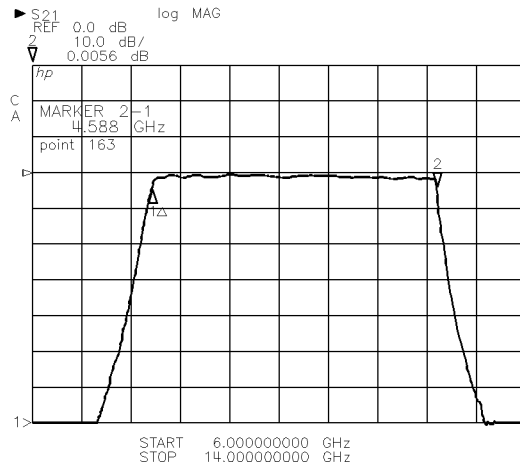

Figure 9-5. Measuring 3 dB Points

Measuring Maximum and Minimum Values

Measure the maximum and minimum values of the response using this sequence.

1. Find the appropriate start/stop or center/span frequencies over which the maximum and minimum values are to be measured. Then perform appropriate measurement calibration over this frequency range.
2. Press **MARKER** **MARKER 1** **MORE** **MARKER TO MINIMUM**.
3. Press **PRIOR MENU**.
4. Press **MARKER 2** **Δ** **MODE MENU** **Δ** **REF = 1** **MORE** **MARKER TO MAXIMUM**.

Marker 2 is active, and the Active Entry shows the difference between Marker 1 (at the trace minimum) and Marker 2 (at the trace maximum).

In the example shown below, the test frequencies are chosen so that passband flatness can be measured. Marker 1 is set to the minimum value and marker 2 is set to the maximum value. The sequence provides direct readout of the peak-to-peak difference in the trace.

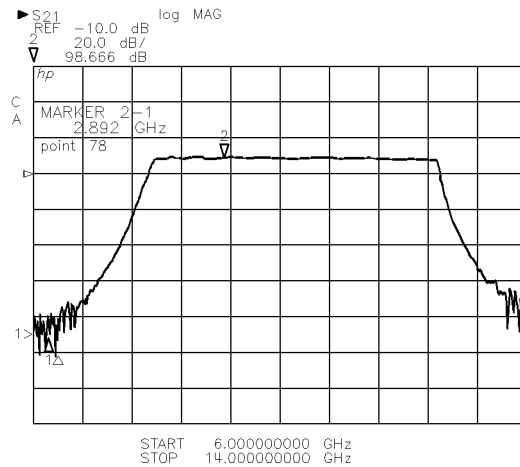

Figure 9-6. Measuring Minimum and Maximum Insertion Loss

Making Insertion Phase Measurement

This sequence lists the steps for a typical insertion phase measurement.

1. Perform appropriate S_{21} or S_{12} measurement calibration.
2. Connect the DUT.
3. Select **PHASE**.
4. Press **MARKER** and read insertion phase (degrees).

Figure 9-7 shows a bandpass filter insertion phase display using the **PHASE** format. The measurement range is +180 degrees to -180 degrees, and the vertical line represents the transition between these two values. Thus, the trace between any two of these transitions represents 360 degrees of phase shift.

To illustrate the display format, determine the total phase shift for the selected sweep width as follows:

1. Position the marker as far to the left as possible and note the phase reading.
2. Determine the number of degrees before the first transition.
3. Count the second and following transition traces and multiply by 360.
4. Now determine the number of degrees from the last transition trace to the right edge of the screen. The sum of these numbers is the total phase shift over the frequency sweep.

For example, in Figure 9-7:

$$\text{TOTAL PHASE SHIFT} = (49.313 + 180) + 3(360) + 40^\circ = 1349.3^\circ$$

When the transmitted signal is below the noise floor for insertion phase measurements, the LCD/CRT trace usually becomes random.

Making Group Delay Measurements

Reduced phase measurement uncertainty due to error correction provides very meaningful and flexible group delay measurements. This implementation makes it quite simple to make accurate, very high resolution group delay measurements at microwave frequencies.

Group delay is the measurement of signal transit time through a test device. It is defined as the derivative of the phase slope with respect to frequency.

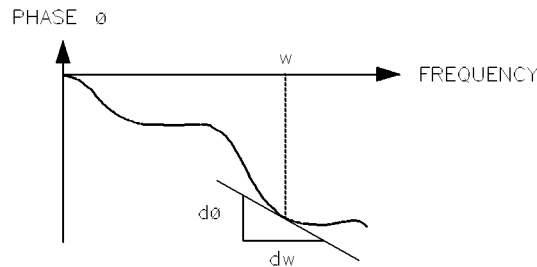

Figure 9-9. Group Delay Definition

The 8510 network analyzer computes group delay from the phase slope. Phase data for the selected parameter is used to find the phase change, $\Delta\varphi$, over a specified frequency aperture, Δf , to obtain a linear approximation for the rate of change of phase with frequency. This value represents the group delay in seconds assuming linear phase change over the frequency aperture Δf .

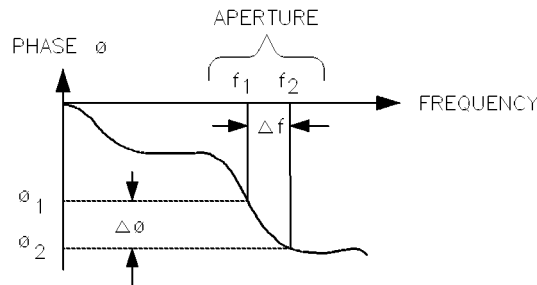

Figure 9-10. Group Delay Aperture

This sequence lists the steps for a typical group delay measurement.

1. Perform appropriate S_{21} or S_{12} measurement calibration.
2. Connect the DUT.
3. Select **DELAY**.
4. Press **MARKER** and read group delay (seconds).

Measurement calibration sets the group delay to zero seconds with a zero-length thru connection. After connecting the test device, a positive measured value indicates transit time through the test device.

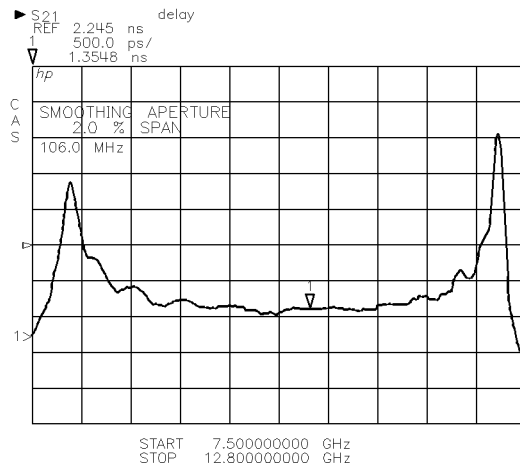

Figure 9-11. Typical Group Delay Display

Discontinuities in the group delay trace may appear if there are more than 180 degrees of phase shift that occur from one frequency point to the next.

Measuring Group Delay Aperture

When comparing group delay measurements, it is very important to know the measurement aperture. With smoothing off, or set to 0.0 percent of span, the minimum aperture for a given sweep width depends on the number of points selected. In Ramp and Step sweeps, the measurement aperture, Δf , is computed from the frequency span and number of points:

$$\text{Measurement Aperture} = \frac{(\text{stop frequency} - \text{start frequency})}{(\text{number of points} - 1)}$$

With smoothing selected, the displayed smoothing aperture represents the percent of span (and the actual Δf) over which the group delay values are averaged to obtain the trace value at any given point.

Press RESPONSE **(MENU)** **SMOOTHING ON**. Use the knob to adjust the smoothing aperture.

If the phase slope is not constant, changing the aperture can result in different values for group delay.

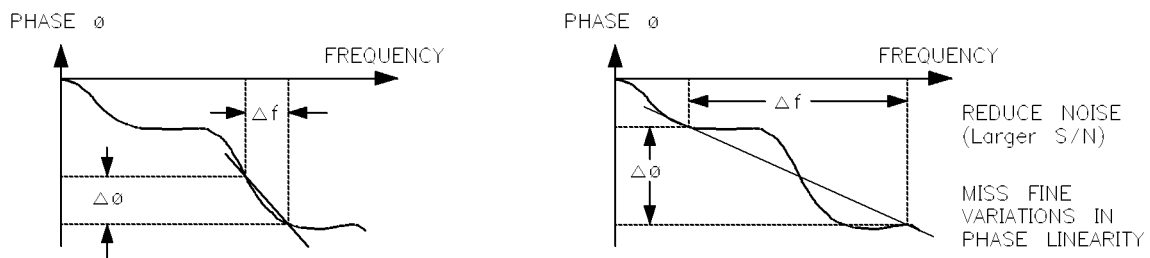

Figure 9-12. Changing the Group Delay Measurement Aperture

Comparing aperture, resolution, and noise. Note that the slope (group delay) varies as the aperture is increased. A wider aperture results in loss of the fine grain variations in group delay. This loss of detail is the reason that in any comparison of group delay data you must know the aperture used to make the measurement.

In selecting the aperture, there is a tradeoff between resolution of fine detail and the effects of noise. The effects of noise can be reduced by increasing the aperture, however, this will tend to smooth out the fine detail. In decreasing the aperture, more fine detail will become visible but the noise will also increase, possibly to the point of obscuring the detail.

Measuring aperture and phase slope. For a specific measurement, the average electrical length or phase slope characteristic of the test device must be considered. To maintain group delay resolution uncertainty below 1 percent, use an aperture which results in a phase change of at least 1 degree.

Using aperture and smoothing. Smoothing is used to change the aperture during the measurement. For example, with smoothing off, group delay is computed using the phase change between each frequency step. With smoothing on, the phase change over the selected percent of sweep is used to compute group delay.

The two LCD/CRT display plots in Figure 9-13 show the effect of increasing the aperture.

Suggestion Use a smaller aperture to assure that fine grain variations are not missed, then increase the aperture to smooth the trace.

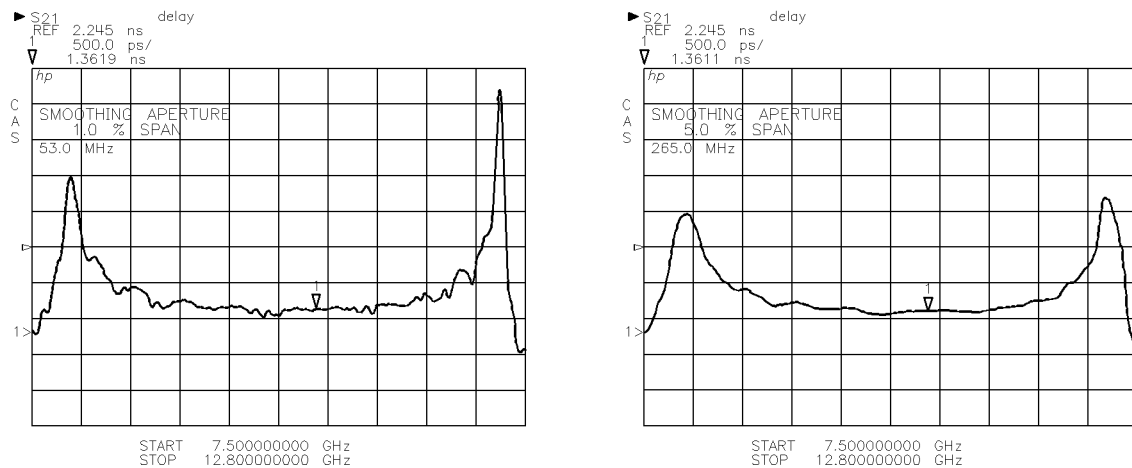

Figure 9-13. Group Delay Plots with Different Aperture Selections

Measuring Deviation from Linear Phase Measurement

For coaxial devices, Insertion Phase consists of two components, linear and non-linear. The linear component can be attributed to the electrical length of the test device and represents the average transit time. As for group delay, the non-linear phase components, or the variations from constant group delay, are interpreted as variations in the electrical length, or transit time, at different frequencies and represent a source of signal distortion. This is also true for dispersive media like waveguide, except that the phase shift attributed to the electrical length of the device is not linear.

Measuring deviation from ideal phase is an alternative to measuring group delay. This is made possible by the range of the Electrical Delay function and the 8510's ability to provide both linear and dispersive electrical delay compensation. By compensating the insertion phase due to the electrical length of the device using the Electrical Delay controls, the deviation from ideal phase over the frequency sweep can be measured directly and viewed at high resolution.

Measuring deviation from ideal phase typically produces greater detail than measuring group delay when the phase response of the device under test changes rapidly over a small frequency range. This is because group delay is a derived measurement (the derivative of the phase change with frequency) and is averaged over the specified aperture.

1. Perform an appropriate measurement calibration.
2. Connect the DUT.
3. Press **PHASE**.
4. Position the marker to the area of interest.
5. Press **RESPONSE** **MENU** **COAXIAL** or **WAVEGUIDE** depending upon whether the media exhibits intrinsic linear or dispersive phase shift.
6. Press **AUTO DELAY**. The electrical delay necessary to make the phase trace flat at the marker position is automatically selected.
7. After you press **AUTO DELAY**, **ELECTRICAL DELAY** becomes the Active Function. You may use the knob (femtosecond resolution), STEP keys (1, 2, 5 sequence), or numeric and units (**X1**=seconds) to change the Electrical Delay value. You should adjust the controls until the displayed trace is flat.

This measurement determines the insertion phase required to equalize the electrical length of the reference and test signal paths. You should adjust the controls until a the displayed trace is flat.

Adding positive Electrical Delay tends to flatten the trace. When the phase response in the area of interest is flat, read the Electrical Delay value in seconds (and the corresponding free space distance in meters).

Note that adding Electrical Delay changes the phase slope and thus changes the group delay measurement. Since Electrical Delay is independent for Channel 1 and Channel 2, you can measure Deviation from Ideal Phase and Group Delay simultaneously, as shown in Figure 9-14. Group Delay is the top trace, Deviation from Linear Phase the bottom trace.

Press **DISPLAY** **DUAL CHANNEL** then **OVERLAY**. Present the deviation from ideal phase display on Channel 1, then select Channel 2, and set **ELECTRICAL DELAY** to zero seconds.

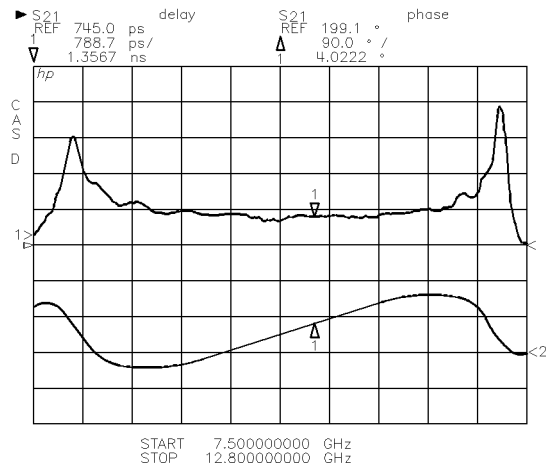

Figure 9-14. Typical Group Delay and Deviation from Ideal Phase Displays

Reflection Measurements

Introduction

This part of the Agilent 8510 network analyzer system manual explains how to measure:

- Reflection return loss
- SWR
- S-parameter
- Impedance
- Admittance

These example measurements are applicable to typical one-port or two-port devices.

To make reflection measurements on multiport devices, all ports except the test port are assumed to be terminated with Z_0 .

Reflection Test Setups

One-Port Devices

To measure 1-port devices, connect the appropriate adapter (if necessary) at port 1, perform the appropriate measurement calibration, then connect the device under test.

Two-Port Devices

When measuring reflection of a two-port device, the device output port must be terminated in Z_0 . This is accomplished either by actually terminating the device output with Z_0 , or by using 2-port error correction to compensate the measurement for the actual terminating impedance.

Reflection Measurement Calibration Choices

The following types of calibration are applicable to reflection measurements:

- Response
- Response and Isolation
- 1-Port calibration
- One-Path 2-Port calibration

Response and Response-and-Isolation Calibrations

A Short Circuit or a Shielded Open Circuit is used as the standard to characterize frequency response errors, and a Load is used to characterize directivity errors.

1-Port Calibration

Use this for fully error-corrected reflection measurements for one-port devices. A Load, a Short Circuit, and a Shielded Open Circuit are used as the standards.

One-Path 2-Port Calibration

This model provides fully corrected transmission and reflection measurements (although not in real time) for a reflection/transmission test set. It uses a Thru, a Shielded Open Circuit, a Short Circuit, and Loads to calibrate at port 1. Follow instructions displayed on the LCD/CRT to manually reverse the test device for measurement of the reverse parameters.

2-Port Calibrations

This model provides fully corrected transmission and reflection measurements with an S-parameter test set. It uses a Thru, a Shielded Open Circuit, a Short Circuit, and Loads to calibrate at port 1 and port 2.

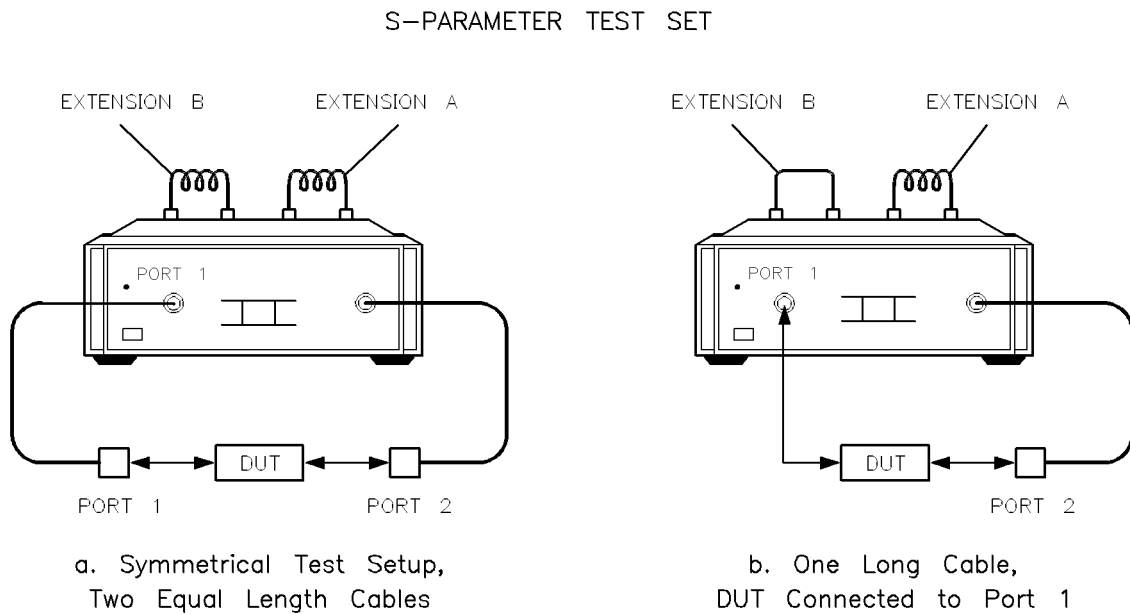

REFLECTION/TRANSMISSION TEST SET

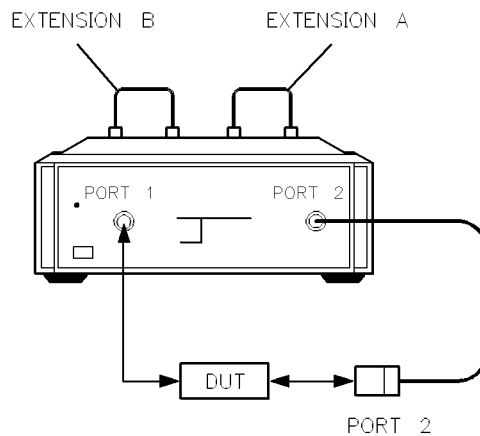

Figure 10-1. Typical Measurement Setup

10-2 Reflection Measurements

Return Loss Measurement

This sequence lists the steps for a typical Return Loss measurement.

1. Perform an appropriate S_{11} or S_{22} measurement calibration.
2. Connect the DUT.
3. Select **LOG MAG**.
4. Press **MARKER**, read Return Loss (dB).

Measurement calibration sets the magnitude and phase ratio between the reference and test signal paths to zero dB at ± 180 degrees with a short circuit at the reference plane. Figure 10-2 shows the return loss of a bandpass filter.

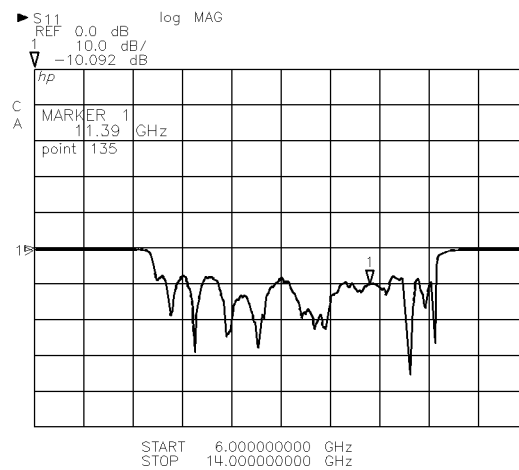

Figure 10-2. Typical Return Loss Display

SWR Measurement

The measurement sequence for Standing Wave Ratio, SWR, is the same as that for Return Loss.

Select the SWR display by pressing **FORMAT** **MENU**, then **SWR**.

SWR is calculated from the Return Loss value using these equations:

$$\rho = 10^{D/20} \text{ where } D = \text{measured value (dB)}$$

$$\text{SWR} = (1 + \rho) / (1 - \rho)$$

For example, if the measured magnitude ratio is -30 dB, then ρ is 0.032 and the SWR is 1.07.

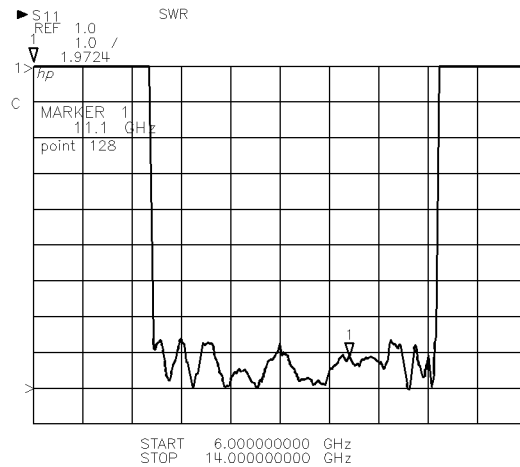

Figure 10-3. Typical SWR Display

S-Parameter Measurement

The procedure for measurement of reflection S-parameters is identical to measurement of Return Loss and reflection phase discussed earlier except that the response is viewed using the **LIN mkr on POLAR** display in the Format menu.

The magnitude is given in linear terms (ρ) and an angle $\angle\theta$, in degrees. A magnitude value greater than one indicates greater than unity reflection; less than one indicates lower than unity reflection. The conversion from dB to linear units is given by the equation

$$\text{dB} = 20 (\log \rho).$$

Note that the **LOG mkr on POLAR** format (Figure 10-4) presents the same data with magnitude given in dB.

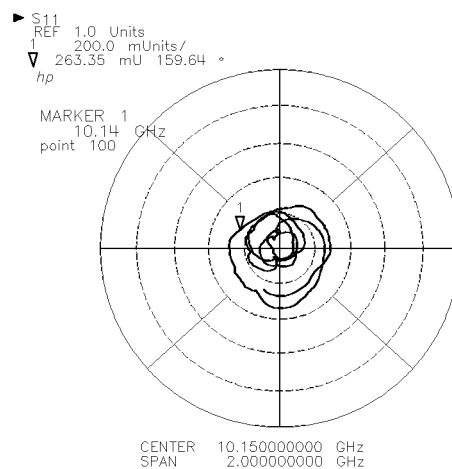

Figure 10-4. Typical S-Parameter Display

Impedance Measurement

Pressing the softkey labeled **SMITH CHART** on the Format Menu presents the reflection measurement using the Smith Chart, providing readout in units of real and imaginary ohms ($R \Omega \pm jx \Omega$). The measurement calibration and measurement procedure are the same as for Return Loss described above. The impedance base for the marker readout is set by the system Z_0 .

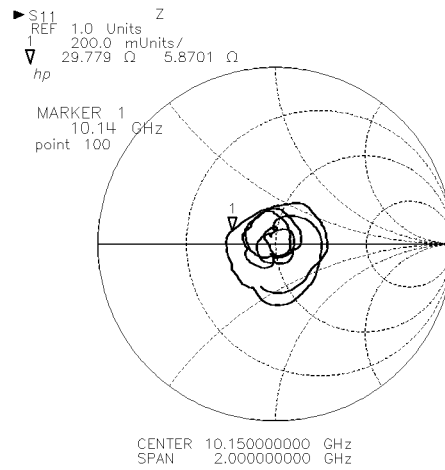

Figure 10-5. Typical Impedance Display

Admittance Measurement

Pressing the softkey labeled **INVERTED SMITH** on the Format Menu presents the reflection measurement using an inverted Smith (Admittance) chart. The readout is in terms of susceptance and conductance ($G \pm jB$). The measurement calibration and measurement procedure are the same as for the Return Loss measurement described above.

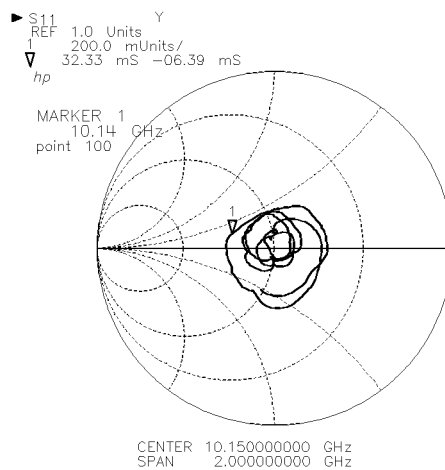

Figure 10-6. Typical Admittance Display

Introduction to Time Domain Measurements

Introduction

This section provides information about making reflection and transmission measurements in time domain mode. Measurements are made in frequency domain are mathematically transformed into time domain using the internal 8510 computer. The system must be equipped with the 8510 Operating System Firmware, Option 010, which contains Time Domain mode. Without this option installed, the message `FUNCTION NOT IMPLEMENTED` is displayed when `TIME DOMAIN` is selected.

Using Front Panel Controls in Time Domain Mode

In Time Domain mode, the front-panel STIMULUS block keys `START`, `STOP`, `CENTER`, and `SPAN` relate to time. They affect the horizontal (time) axis value of the display, independent of the frequency range chosen. Use the RPG knob, step keys, or the keypad for data entry. The keypad terminators also refer to time in seconds, using lowercase annotation. As an example, entering `0.01 G/n` displays 10 picoseconds.

General Theory

The relationship between the Frequency Domain response and the Time Domain response in a network is described with the Fourier Transform:

Frequency Domain \rightarrow Time Domain
 $H(f) \quad \longrightarrow \quad h(t)$

It is therefore possible to measure the response of a device under test (DUT) in the Frequency Domain and then mathematically calculate the inverse Fourier Transform of the data to give the Time Domain response. The 8510C internal computer calculates the time domain response value using Chirp-Z Fast Fourier Transform computation techniques. The resulting measurement is the fully error-corrected Time Domain reflection or transmission response of the device, displayed as a real-time value. Figure 11-1 shows the Frequency and Time Domain reflection responses of the same device.

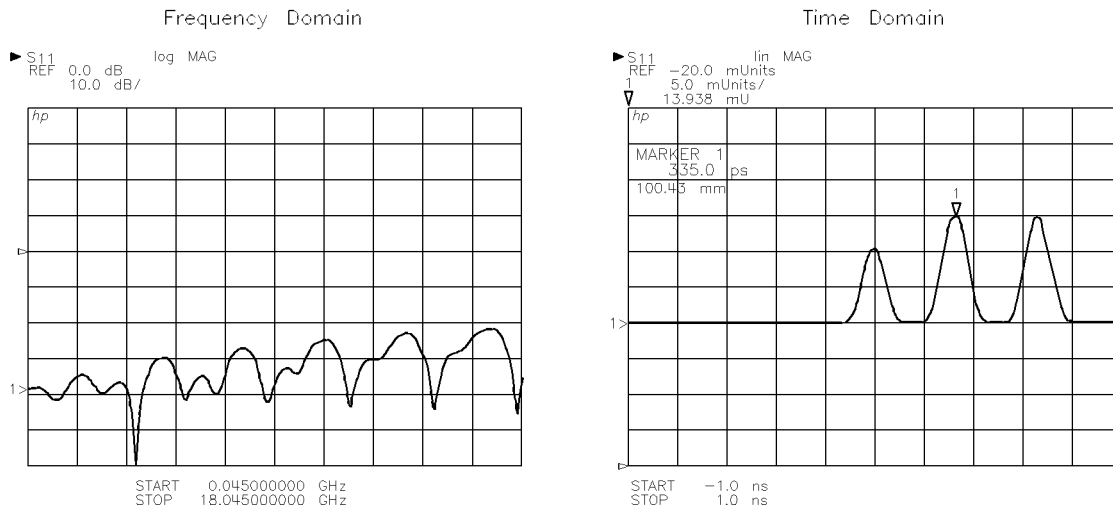

Figure 11-1. Frequency Domain and Time Domain Measurements

- A Frequency Domain reflection measurement is a composite response of all impedance discontinuities found in the device under test.
- A Time Domain measurement provides the effects of all individual discontinuities, as a function of time (or distance).

In time domain, the device response consists of three separate impedance changes, with the second discontinuity having a reflection coefficient magnitude of 0.013. This discontinuity is located 167.5 picoseconds from the reference plane relative to the speed of light in free space. In the time domain trace shown in Figure 11-1, the trace peaks show the round-trip time to each reflection and back (335 picoseconds for the center peak).

Time Domain Modes

The 8510 network analyzer system is equipped with two different time domain modes of operation. These are listed below:

Band Pass Mode The Time Band Pass mode is the most general-purpose mode of operation. It gives the impulse response of the device, works on any device over any frequency range, and is relatively simple to use. It is especially helpful for measuring band-limited devices and for making fault location measurements.

The impulse is an RF burst comprising the frequency domain stimulus frequencies having an impulse-shaped envelope. This is a distinct advantage over traditional TDR, which requires that the DUT be able to operate at DC. With Time Band Pass, there are no restrictions on the frequency range of the measurement.

Low Pass Mode The Time Low Pass mode is used to simulate a traditional Time Domain Reflectometer (TDR) measurement. The response can be viewed as if the device were stimulated by either an impulse or a step function. The response helps to determine the type of discontinuity present (R, L, or C). This mode has special frequency setting requirements and assumes that the device has adequate frequency response over a broad range of the frequency domain stimulus, especially the low frequencies.

Time Domain Band Pass

Reflection Measurements Using Time Band Pass

As an example of a 0 using Time Band Pass, consider the reflection of a short or a load at the end of a cable or air transmission line. The sliding load is shown here. Before making Time Domain reflection measurements, it is necessary to perform the appropriate measurement calibration.

FACTORY PRESET sets all instruments in the system to a known state, but it has the disadvantage of putting all the instruments through self-test. The unwanted self-test can take several minutes, depending on the instruments in your system.

To save time, press **FACTORY PRESET** once, then save the instrument state to save register 8, the user preset register. Then, instead of pressing **FACTORY PRESET**, you can simply press the green **(USER PRESET)** key and recall an instrument state.

1. Press **(USER PRESET)**. Save the preset state to a save register for future use.
2. Perform an S_{11} 1-PORT calibration. Leave the sliding load connected and observe the Frequency Domain response as the sliding element is moved.
3. Press **(DOMAIN)**, **TIME BAND PASS**.
4. Press **AUTO** to display the trace and observe the Time Domain response as the sliding element is moved. Typical Frequency Domain and Time Domain responses of a sliding load are shown in Figure 11-2.
5. Move the sliding element and observe the response in both Frequency and Time Band Pass. If a high quality sliding load is used and the calibration is adequate, the Frequency Domain measurement of the sliding load should change very little when the slide is moved. However, the Time Domain measurement shows the individual response of the load element, and it moves along the horizontal axis as the slide is moved.

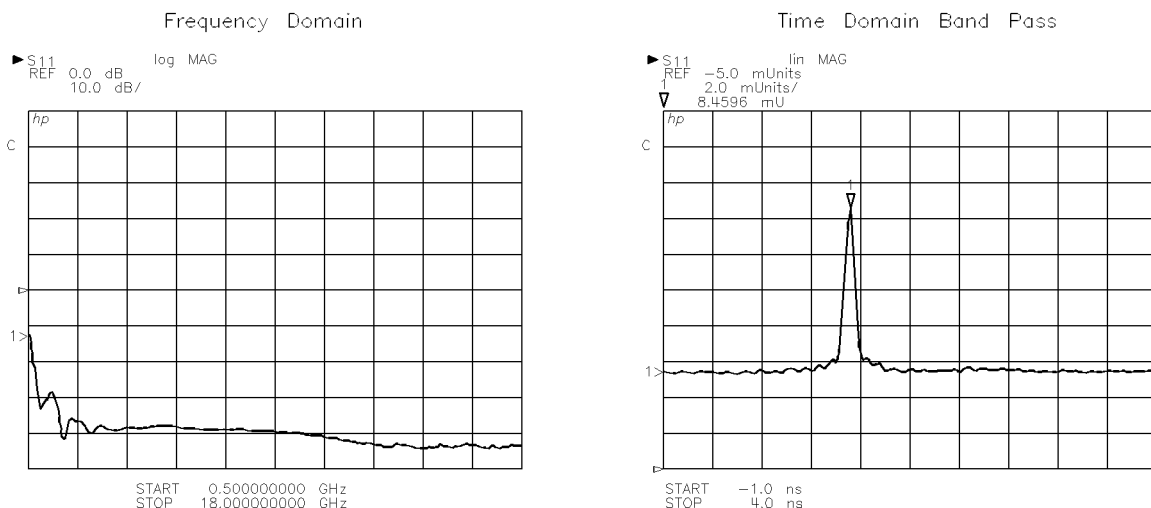

Figure 11-2. Measurement of a Sliding Load

Interpreting the Time Band Pass Reflection Response Horizontal Axis

In Time Band Pass reflection measurements, the horizontal axis represents the amount of time that it takes for an impulse, launched at the test port, to reach the discontinuity and return. Thus, this is the two-way travel time to the discontinuity, which in Figure 11-2 is the load element of the sliding load.

The Marker reads out both the time (x2) and the electrical length (x2) to the discontinuity. The electrical length is obtained by multiplying the time by the velocity of light in free space (2.997925E8 m/sec). To get the physical length, multiply the displayed electrical length by the relative velocity of light in the transmission medium, or use the 8510 `VELOCITY FACTOR` function.

Interpreting the Time Band Pass Reflection Response Vertical Axis

The quantity displayed on the vertical axis depends on the format selected. Time Band Pass presets to the Linear Magnitude format which displays the response in reflection coefficient units. This can be thought of as an average reflection coefficient of the discontinuity over the frequency range of the measurement.

Other useful formats are listed in Table 11-1. The Time Band Pass response gives the magnitude of the reflection only and has no impedance information (R, L, or C). This information is available, however, in the Time Low Pass response.

Table 11-1. Useful Time Band Pass Formats

Format	Trace Value
LINEAR MAG	Reflection Coefficient Units
LOG MAG	Return Loss (dB)
SWR	SWR Units

Fault Location Measurements Using Time Band Pass

The Time Band Pass mode is very useful in making fault location measurements. Figure 11-3 shows the Band Pass Time Domain measurement of a length of coaxial cable having multiple discontinuities and terminated in 50 ohms. Note the responses of each discontinuity and of the terminating element.

Time Domain Band Pass

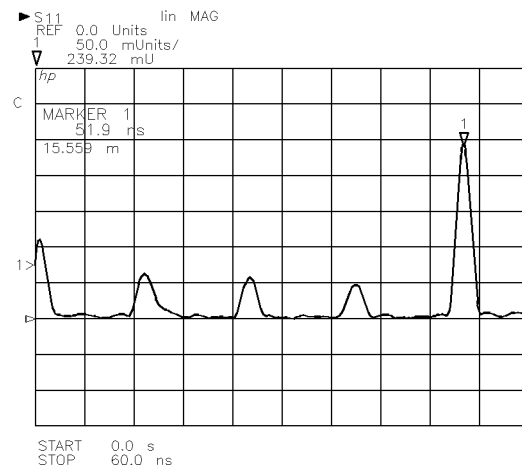

Figure 11-3. Cable Fault Location Measurement Using Time Band Pass

Also, because the Time Band Pass mode will work over any frequency range, it can be used to do fault location in band-limited transmission media, such as waveguide. Using Velocity Factor along with Waveguide Electrical Delay can produce accurate distance measurements in dispersive media.

Transmission Measurements Using Time Band Pass

The Time Band Pass mode is also useful in making transmission measurements. It provides the means to analyze the length and loss of multiple signal propagation paths of the device. Before making Time Domain transmission measurements, it is necessary to perform the appropriate measurement calibration.

1. Press **USER PRESET**, or recall an instrument state in which you have saved preset values.
2. Perform an appropriate transmission measurement calibration.
3. Connect a 20 dB coaxial attenuator and observe the Frequency Domain response.
4. Press **DOMAIN**, **TIME BAND PASS**.
5. Press **AUTO** to display the trace.

The Frequency Domain and Time Domain responses of a 20 dB attenuator are shown in Figure 11-4.

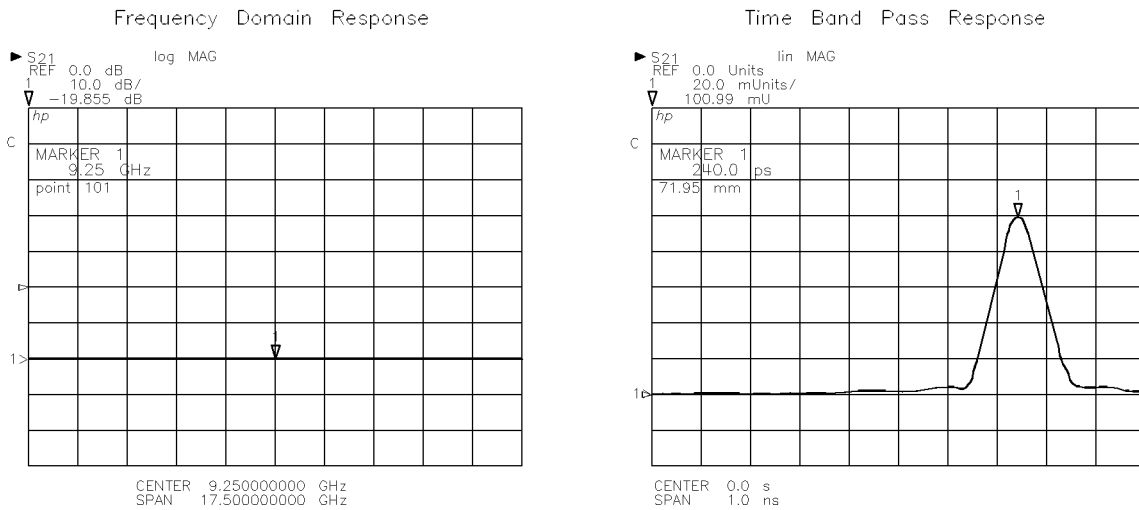

Figure 11-4. Transmission Measurement in Time Band Pass

Interpreting the Time Band Pass Transmission Response Horizontal Axis

In Time Domain transmission measurements, the horizontal axis is displayed in units of time. The response of the thru connection used in the calibration is an impulse at $t = 0$ seconds and with unit height, indicating that the impulse made it through in zero time and with no loss. When a device is inserted, the time axis indicates the propagation delay or electrical length of the device. Note that in Time Domain transmission measurements, the value displayed is the actual electrical length (not x2). The Marker reads out the electrical length in both time and distance. You must multiply the distance number by the relative velocity of the transmission medium to get the actual physical length, or use the 8510 Velocity Factor function.

Interpreting the Time Band Pass Transmission Response Vertical Axis

The vertical axis displays the transmission response in transmission coefficient units in the Linear Magnitude format and the transmission loss or gain in dB in the Log Magnitude format. This can be thought of as an average transmission coefficient of the signal path over the frequency range of the measurement. For the 20 dB attenuator example, the Band Pass response has a magnitude of 0.10 transmission coefficient units (-20 dB insertion loss).

Time Domain Low Pass

The Time Low Pass mode is used to simulate a traditional TDR measurement. This mode gives the user information to determine the type of discontinuity (R, L, or C) that is present. Time Low Pass provides the best resolution (fastest rise time), and it may be used to give either the Step or Impulse response of a device.

Low Pass Mode Requirements

The Time Low Pass mode is less general purpose than Time Band Pass in that it places strict limitations on the frequency range of the measurement. It requires that the Frequency Domain data points be harmonically related from dc to the Stop frequency (Stop = $n \times$ Start, where n = Number of Points). The DC frequency response is extrapolated from the low frequency data. The requirement to pass DC is the same limitation that exists for traditional TDR measurements.

Setting Frequency Range for Time Low Pass

To set the frequency range for measurement using Time Low Pass, first select Number of Points, enter the desired Stop frequency, then press the **SET FREQ (LOW PASS)** softkey, either on the Cal Type menu, or after pressing **TIME LOW PASS** on the Domain menu. Notice that the Start and Stop frequencies may be changed. This is in order to meet the mathematical requirements of the time domain transformation.

The 8510B sets the Time Low Pass frequency range as shown in Table 11-2. After you press **SET FREQ (LOW PASS)**, first the instrument computes Stop = $n \times$ Start, where n is the Number of Points. If the Stop frequency is above the maximum shown for “DC Extrapolation,” then the Start frequency is increased to make the frequency points harmonically related. If the Stop frequency is below the value shown for “2-Point Extrapolation,” then the Stop frequency is increased. If your device can be measured over this frequency range, proceed with the measurement. If not, then change the number of points and try again. If an appropriate Time Low Pass frequency range is not possible, then use Time Band Pass.

Table 11-2. Maximum Frequency Ranges for Time Low Pass

Number of Points	Minimum Frequency Range (GHz)		
	Start	Stop	
		2-point	DC
51	0.045	1.170	2.295
101	0.045	2.295	4.545
201	0.045	4.545	9.045
401	0.045	9.045	18.045
801	0.045	18.045	36.045

Since the time low pass transformation requires a data point at DC, and the network analyzer does not measure below 45 MHz, the value of the DC data point is always extrapolated from the value of the lowest frequency point measured. This sets the minimum frequency range shown in Table 11-2 for “DC” Extrapolation, using 45 MHz as the Start frequency.

In order to accommodate applications where this method would result in a Stop frequency that is too high, the 8510 also incorporates “2-Point” Extrapolation. If the Stop frequency is between the minimum for 2-Point Extrapolation and the value for DC Extrapolation, then an additional data point between DC and the Start frequency is extrapolated. This reduces the minimum frequency range to:

$$45 \text{ MHz} \left(\frac{(n + 1)}{2} \right)$$

which is one-half of the minimum frequency range requirement for DC extrapolation.

Because the 8510 will not convert to the Low Pass mode until the **SET FREQ. (LOW PASS)** key is pressed at least once, it is very important that this be done before calibrating. Otherwise, going to Time Low Pass will change the measurement frequencies which will turn off error correction.

Avoiding Noise

When the Start frequency data is noisy, the trace will be unstable and difficult to interpret. If the minimum Stop frequency range is beyond the upper bandwidth of the device and the frequency domain data is noisy, then the time domain responses will also be unstable.

Analyzing Time Low Pass Reflections

As mentioned, Time Low Pass gives the TDR response of the device under test. This response contains information that is useful in determining the type of discontinuity you are viewing. Before making actual measurements using Time Low Pass mode, it is helpful to review the Time Low Pass response of a known discontinuity. Figure 11-5 shows the resultant Time Low Pass S_{11} response waveform for some various discontinuities viewed with either a Step or an Impulse stimulus. (Mathematically, the Time Low Pass Impulse stimulus is the derivative of the Step stimulus.)

Reflection Measurements using Time Low Pass

To make a reflection measurements in the Time Low Pass mode, use the following procedure:

1. Press **USER PRESET**, or recall a save/recall register that has preset conditions stored in it.
2. Press **CAL**, then press either **CAL 1 (7 mm)** or **CAL 2 (3.5 mm)**.
3. Press **SET FREQ. (LOW PASS)**.
4. Perform an S_{11} 1-PORT calibration.
5. Connect a 25 Ω airline and broadband load.
6. Press **DOMAIN**, **TIME LOW PASS**, **SET FREQ. (LOW PASS)**.
7. Press **AUTO** to view the STEP response (example in Figure 11-6).
8. To view the Low Pass Impulse response of the device, press **DOMAIN**, **SPECIFY TIME**, **IMPULSE (LOW PASS)**.

Time Domain Low Pass

Interpreting the Time Low Pass Reflection Response Horizontal Axis

The horizontal axis for the Low Pass measurement is the 2-way travel time to the discontinuity, the same as for the Time Band Pass mode. Also, the Marker function displays both the time (x2) and electrical length (x2), obtained by multiplying the time by the velocity of light in a vacuum (2.997925E8 m/sec). To get the actual physical length, multiply by the relative velocity of light in the propagation medium, or use the `VELOCITY FACTOR` function.

Interpreting the Time Low Pass Reflection Response Vertical Axis

The vertical axis depends upon the format chosen. In Time Low Pass, the most useful format is `REAL`, which displays the TDR response in reflection coefficient units.

This points out a key difference between Time Band Pass and Time Low Pass modes:

- | | |
|-----------|--|
| Band Pass | This measurement is actually the response of the device to an RF pulse with an impulse shaped envelope. The Inverse Fourier Transform Frequency Domain data gives a response that is a function of this simulated RF waveform. For ease of interpretation only, the magnitude portion of this response that is displayed. This is why the default display format for this mode is LIN MAG. |
| Low Pass | Because the Frequency Domain data is taken at harmonically related frequencies down to DC, the Inverse Fourier Transform has only a real part (the imaginary part is zero). Therefore, the most useful format for the Low Pass mode is the REAL format. Other useful formats are listed in Table 11-3. |







ANALYZING LOW PASS REFLECTIONS		
IMPEDANCE	LOW PASS STEP RESPONSE	LOW PASS IMPULSE RESPONSE
SHORT		
OPEN		
$R > Z_0$		
$R < Z_0$		
SHUNT C		
SERIES L		
SERIES C		
SHUNT L		

Figure 11-5. Time Low Pass Step and Impulse Responses

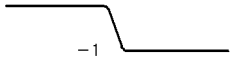
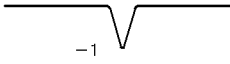
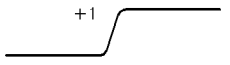
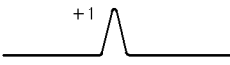
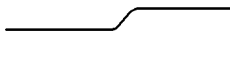
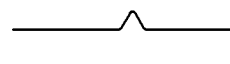
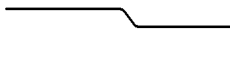
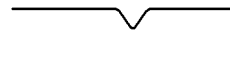
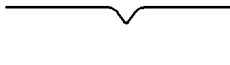
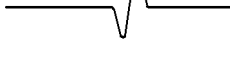
These Time Domain responses were generated using the Circuit Modeling Program (CMP) which is supplied with the Time Domain option.

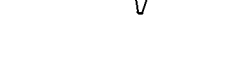
Time Domain Low Pass

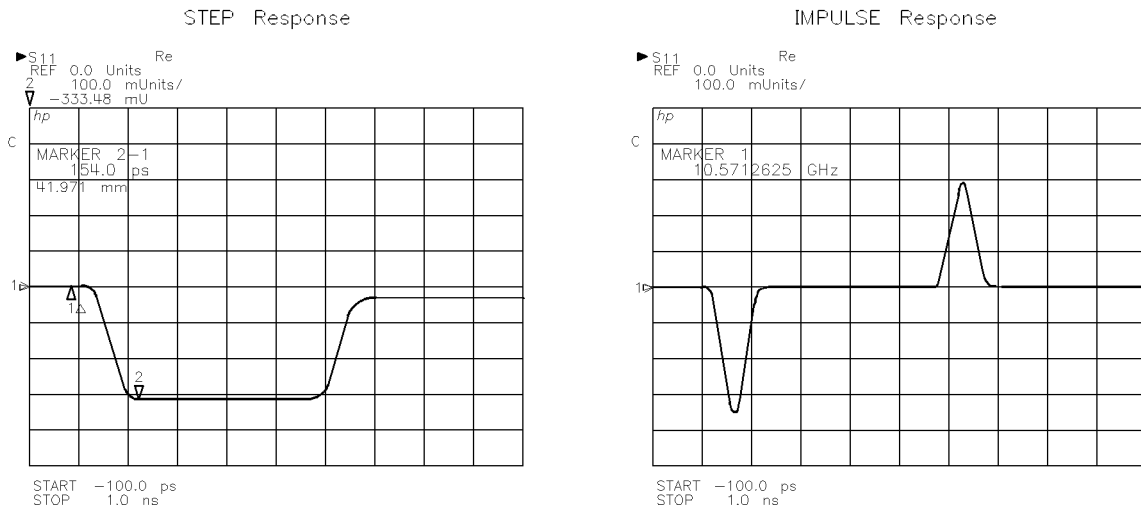

Figure 11-6. Time Low Pass Step Response of a 25 Ω Airline and Fixed Load

Table 11-3. Useful Time Low Pass Formats

Format	Trace Value
LINEAR MAG	Reflection Coefficient Units
LOG MAG	Return Loss (dB)
SWR	SWR Units

Trace Bounce

Depending on the magnitude of the response and on the test set used, the TIME Low Pass Step response of the device may exhibit a phenomenon called display trace bounce. This is normal, and it can be improved by turning on trace averaging. Trace bounce may be caused by a loss of measurement dynamic range at low frequencies due to lack of low frequency response of the test setup, or of the device under test. For example, the coupler-based Agilent 8414B test set rolls-off below 500 MHz (down -30 dB at 45 MHz). The trace bounce is a factor of 30 times less the bridge-based Agilent 8515A test set which has flat magnitude frequency responses down to 45 MHz.

As a second example of Low Pass reflection measurements, consider the Low Pass Step response of a 30 cm airline and fixed load, shown in Figure 11-7.

The Time Low Pass response at $t = 0$ seconds is that of the airline connection. By comparing this response with the theoretical Time Low Pass responses, one can determine whether the mismatch present is capacitive or inductive. The discontinuity at the first connection of the airline is capacitive. The upward slope of the center section of the response is caused by the series loss in the airline. The second major response is that of the fixed load.

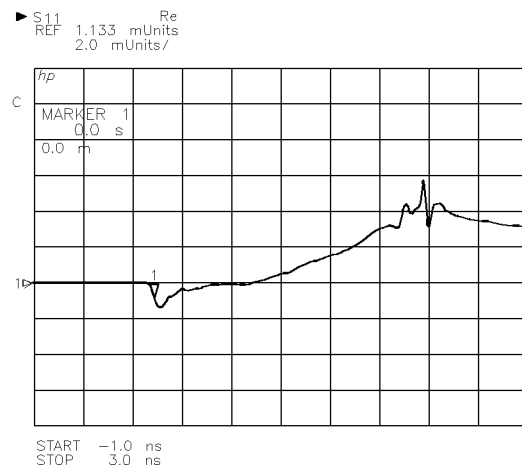

Figure 11-7. Step Response of a 30 cm Airline and Fixed Load

Time Domain Concepts

This section discusses in-depth time domain concepts, including:

- Masking
- Windowing
- Range
- Resolution
- Gating
- Measurement recommendations

Masking

Masking occurs when an Impulse or Step response of one discontinuity affects (or hides) the response of subsequent discontinuities in the circuit. This occurs because the energy reflected from (or absorbed in) the first discontinuity never reaches the second. In the 25Ω airline example (Figure 11-6), the Time Low Pass step response shows a -0.33 reflection coefficient at the first discontinuity, which is the correct value for an impedance of 25Ω. However, at the end of the 25Ω section, the response does not return to zero reflection coefficient, which would be expected for a 50Ω impedance. The reason is that the step incident on the second response is of less than unity amplitude because of the energy reflected in the first mismatch.

As a second example of masking, consider the Time Domain response of a 3 dB attenuator and a short circuit. The Impulse response of the short circuit alone, Figure 11-8, shows a return loss of 0 dB. However, the response of the short circuit placed at the end of the 3 dB attenuator displays a return loss of -6 dB. This value actually represents the forward and return path loss through the attenuator, and it illustrates how a lossy network can affect the responses that follow it.

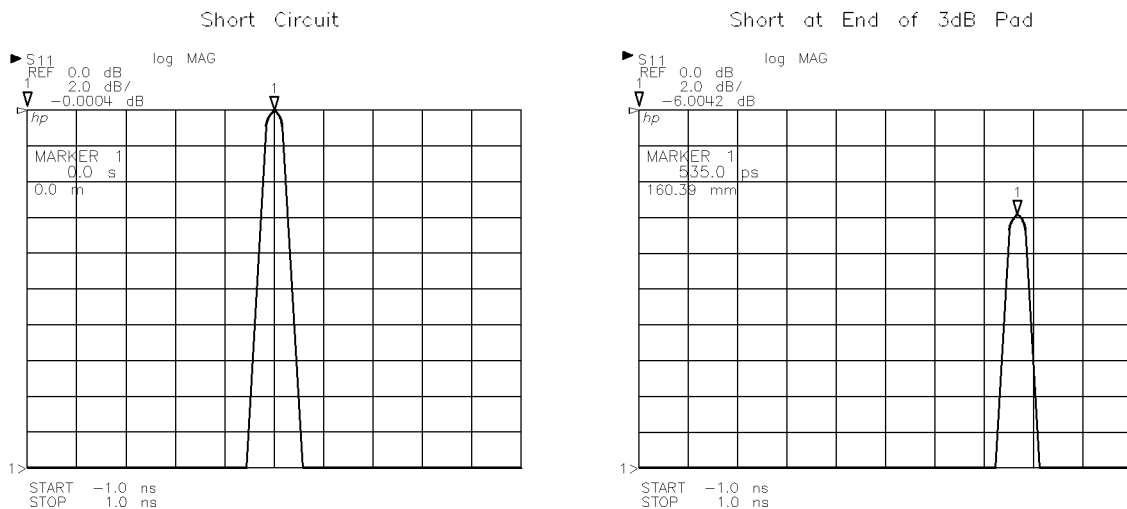

Figure 11-8. Masking Example: 3 dB Pad and Short Circuit

Windowing

The 8510 has a feature called Windowing that is designed to enhance Time Domain measurements. The need for Windowing is due to the abrupt transitions in the Frequency Domain measurement at the Start and Stop frequencies. This band limiting of the Frequency Domain response causes overshoot and ringing in the Time Domain response. It causes the (un-windowed) Impulse stimulus to have a $\sin(kt)/kt$ shape ($k = 1/\text{frequency span}$), which has two effects that limit the usefulness of the Time Domain measurement:

- | | |
|----------------------|---|
| Finite Impulse Width | This limits the ability to resolve between two closely spaced responses. The effects of the finite impulse width cannot be improved without increasing the frequency span of the measurement. See Figure 11-9. |
| Sidelobes | The Impulse sidelobes limit the dynamic range of the Time Domain measurement by hiding low level responses within the sidelobes of the higher level responses. The effects of sidelobes can be improved by Windowing. See Figure 11-10. |

Windowing improves the dynamic range of the Time Domain measurement by modifying (filtering) the Frequency Domain data prior to conversion to the Time Domain to produce an impulse stimulus with lower sidelobes. This greatly enhances the effectiveness in viewing Time Domain responses that are very different in magnitude. The sidelobe reduction is achieved, however, with the tradeoff with increased impulse width. The effect of Windowing on the Step stimulus (integral of the impulse stimulus, Time Low Pass mode only) is a reduction of overshoot and ringing with the tradeoff with increased rise time.

Three Windows are available:

- MINIMUM is essentially no window and therefore gives the highest sidelobes.
- NORMAL (selected by **FACTORY PRESET**) gives reduced sidelobes and is normally the most useful.
- MAXIMUM gives the minimum sidelobes and thus provides the greatest dynamic range.

The Window may be selected by pressing **DOMAIN, SPECIFY TIME**, then selecting **MINIMUM**, **NORMAL**, OR **MAXIMUM**. The sidelobe levels of the Time Domain stimulus depend only on the Window that is selected (see Figure 11-10).

Time Domain Concepts

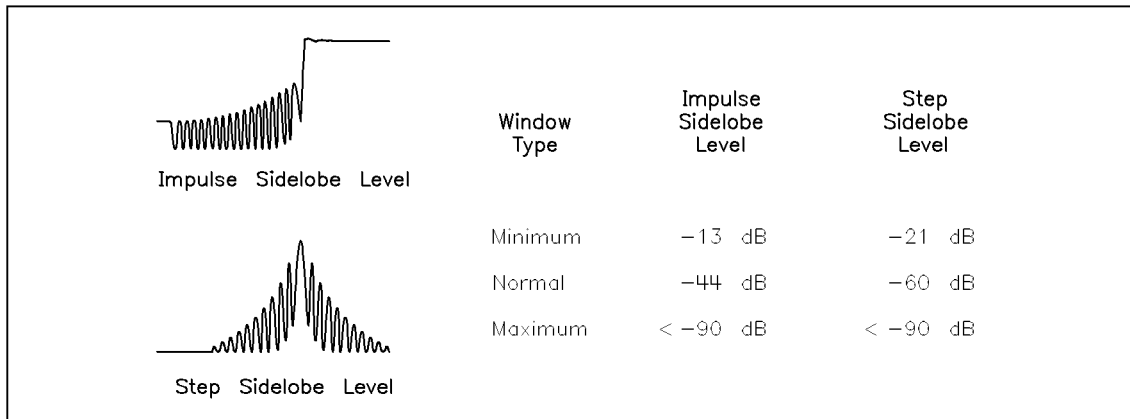

Figure 11-9. Time Domain Window Characteristics

The sidelobe reduction due to Windowing is achieved at a tradeoff with an increase in the Step (10% – 90%) Rise Time and the Impulse (50%) width. These parameters also depend upon the frequency span of the measurement, and they can be calculated using the approximate formulas given in figure below.

LOW PASS		
Step Rise Time (10% to 90%) =	$\frac{0.45}{\text{frequency Span}}$	X { 1.0 Minimum Window 2.2 Normal Window 3.3 Maximum Window
Impulse Width (50%) =	$\frac{0.60}{\text{frequency Span}}$	X { 1.0 Minimum Window 1.6 Normal Window 2.4 Maximum Window
BAND PASS		
Impulse Width (50%) =	$\frac{1.20}{\text{frequency Span}}$	X { 1.0 Minimum Window 1.6 Normal Window 2.4 Maximum Window

Figure 11-10. Approximate Formulas for Step Rise Time and Impulse Width

Multiply by the velocity of light in a vacuum (2.997925E8 m/sec) to get electrical length, and then by the relative velocity of light in the propagation medium to get physical length.

The purpose of windowing is to make the Time Domain response more useful in isolating and identifying individual responses. The window does not affect the displayed Frequency Domain response. It is turned on only when the Time Domain response is viewed. Figure 11-11 shows typical effects of windowing on the Time Domain response of the reflection measurement of a short circuit.

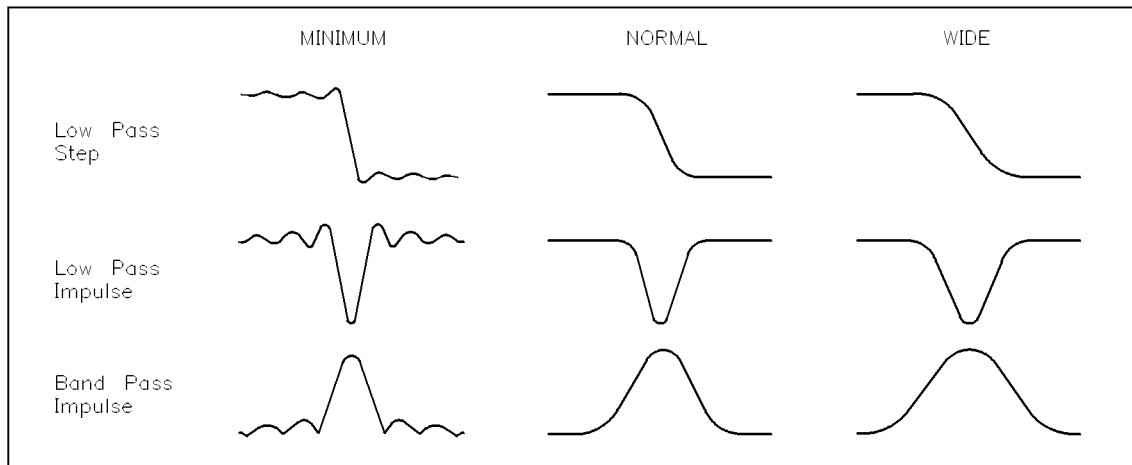

Figure 11-11. Effect of Windowing on Time Domain Responses of a Short Circuit

Range

In the Time Domain, the RANGE is defined as the length in time that a measurement can be made without encountering a repetition of the response (see Figure 11-12). The repetition of the Time Domain response occurs at regular intervals of time and is a consequence of the Frequency Domain data being taken at discrete frequency points rather than being continuous.

The Range of a measurement is equal to $1/\Delta F$, the spacing between frequency data points. It is therefore directly proportional to the number of points and inversely proportional to the Frequency Span (Stop – Start frequency) and can be calculated using the following formula.

$$\text{RANGE} = 1/\Delta F = (\text{Number of Points} - 1)/\text{Frequency Span}$$

As a sample calculation, for a 201 point measurement from 50 MHz to 18 GHz (SPAN = 17.95 GHz), the Range is:

$$(201 - 1)/17.95 \text{ GHz} = 11.1 \text{ nsec (3.34m)}.$$

Thus the device under test has to be 3.34 m or less in electrical length for a transmission measurement (1.67 m for a reflection measurement) or else an overlapping of the Time Domain responses (aliasing) will occur. (Remember to multiply by the relative velocity of light in the medium to get actual physical length.)

Time Domain Concepts

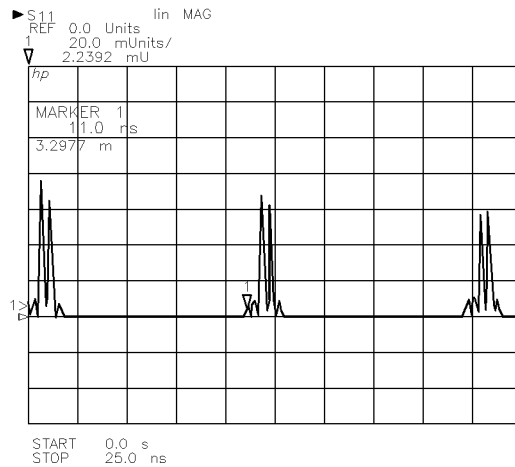

Figure 11-12. Time Domain Measurement Showing Response Repetitions

To increase the Time Domain measurement Range, it is usually better to first increase the number of points, because decreasing the frequency span will reduce the Time Domain resolution.

Resolution

There are two different terms involving resolution in Time Domain: Response-Resolution and Range-Resolution, shown in Figure 11-13.

Response Resolution

The Time Domain Response Resolution is defined as the ability to resolve two closely spaced responses. In other words, if two responses are present, this is how closely they can be spaced and still be distinguished from one another. For responses of equal amplitude, the Response Resolution is equal to the 50% (-6 dB) impulse width. It therefore is inversely proportional to the frequency span of the measurement and is also a function of the window that is used. Approximate formulas for calculating the 50% Impulse width are given in Figure 11-10. For responses that are of different amplitudes, the Response-Resolution will be slightly wider than one impulse width.

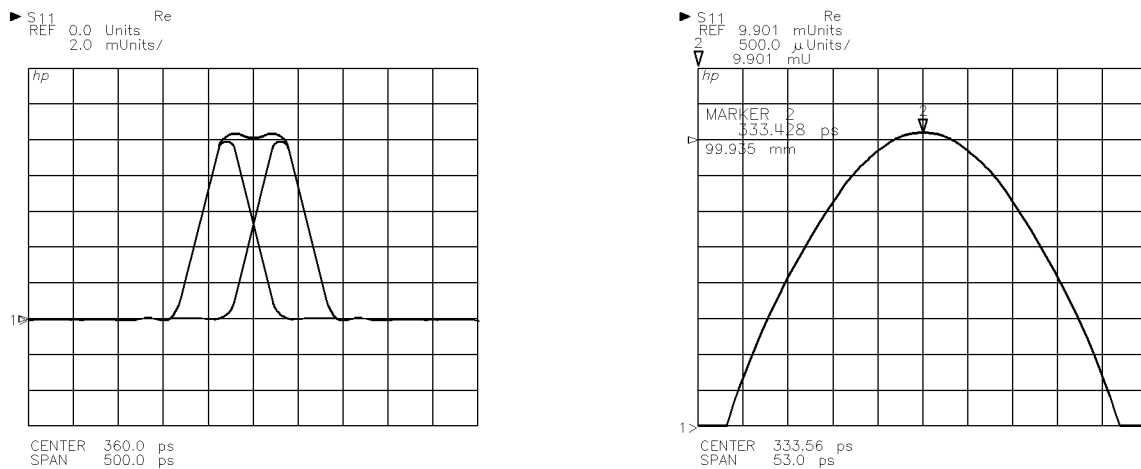

Figure 11-13. Resolution in Time Domain

Range Resolution

Range Resolution is defined as the ability to locate a single response in time. In other words, if only one response is there, this is how closely you can pinpoint the peak of that response. The Range Resolution is equal to the digital resolution of the LCD/CRT (which is the time span displayed divided by the number of points). Maximum Range Resolution is achieved by centering the response on the display and then reducing the time span. Therefore, the Range Resolution is always much finer than the Response Resolution.

To illustrate the difference between these two resolution terms, consider a measurement with a frequency span of 18 GHz. For Time Low Pass, with a Normal Window, the Response-Resolution (Impulse width) is 53 psec ($0.6 \times (1/18 \text{ GHz}) \times 1.6$) or 16 mm in electrical length ($53 \text{ psec} \times 2.997925\text{E}8 \text{ m/sec}$). As illustrated in Figure 11-13, two Time Domain responses of equal amplitude separated by 16 mm could begin to be resolved in this Time Domain measurement. (This indicates an actual discontinuity separation of 8 mm for reflection measurements.)

Now consider the case where only one response is present. By centering that response on the display and adjusting the time SPAN to equal the 50% Impulse width (53 psec, 16 mm), Figure 11-13, the Range Resolution is reduced to $40 \mu\text{m}$ ($16 \text{ mm}/401 \text{ points}$). The Range-Resolution can be further reduced by narrowing the time span.

Gating

The 8510 gating feature gives the user the flexibility to selectively remove reflection or transmission Time Domain responses. In converting back to the Frequency Domain, the effects of the responses outside the Gate are removed. In a reflection measurement, you can remove the effects of unwanted mismatches or else isolate and view the response of an individual mismatch. In a transmission measurement, you can remove the responses of multiple transmission paths.

Time Domain Concepts

Setting the Gate

A Gate is a time band pass filter used to filter out unwanted Time Domain responses. Responses outside the selected gate are not included in the trace. There are three Gate indicators:

START and STOP The Gate START and STOP indicate the -6 dB cutoff times. Gate SPAN = STOP – START.

CENTER The GATE CENTER indicates the center time (not frequency) of this filter.

The Gate has a bandpass filter shape, as shown in Figure 11-14.

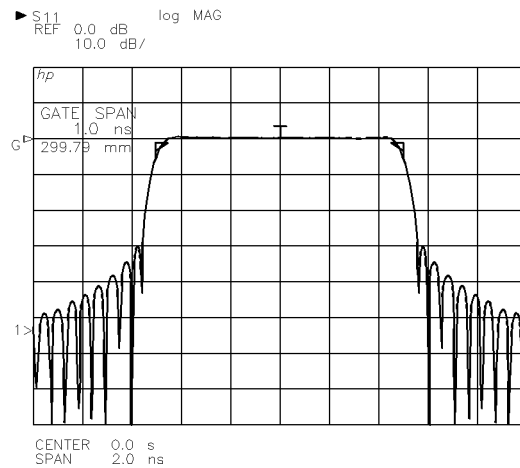

Figure 11-14. Typical Gate Shape

Figure 11-15 shows the Frequency Domain and the Band Pass Time Domain responses of a 7 mm to 3.5 mm adapter connected to a 3.5 mm airline and a fixed load.

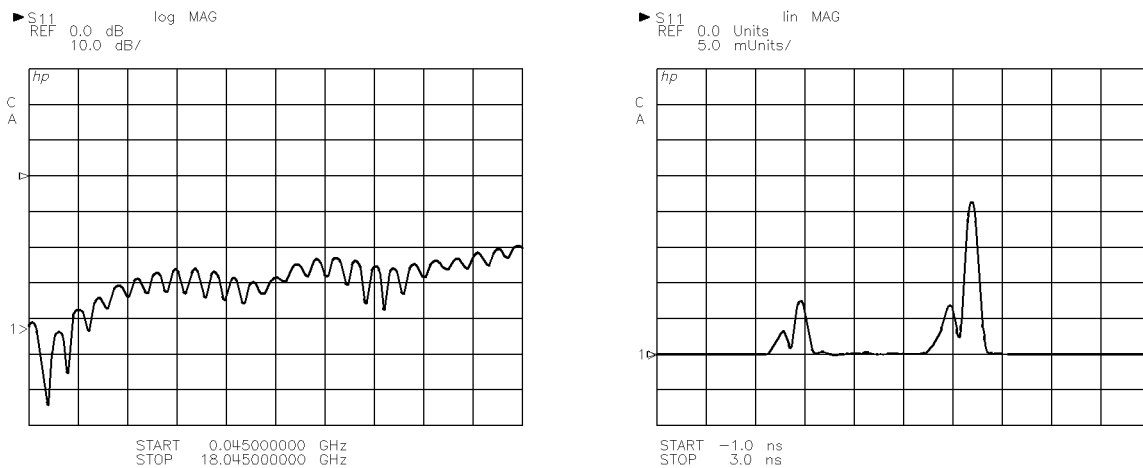

Figure 11-15. Reflection Measurement of 7-mm to 3.5-mm Adapter, Airline, and Load

We will now use gating to analyze the response of the adapter only.

11-20 Introduction to Time Domain Measurements

1. Press **DOMAIN**, **TIME BAND PASS**, **SPECIFY GATE**. The three Gate indicators will now appear on the screen.
2. Press **GATE CENTER**, and use the knob or keypad to move the center indicator to $t = 0$.
In Figure 11-16, the time domain display shows the gate center, 86 ps, as the Active Function.
3. Press **GATE SPAN** and use the knob or keypad to adjust the Gate Span to 0.70 ns.
4. Press **GATE ON** to turn on the Gate.
The responses outside the Gate will be removed. See Figure 11-16.
5. Press **DOMAIN**, **FREQUENCY**.

View the gated Frequency Domain response of the adapter. See Figure 11-16.

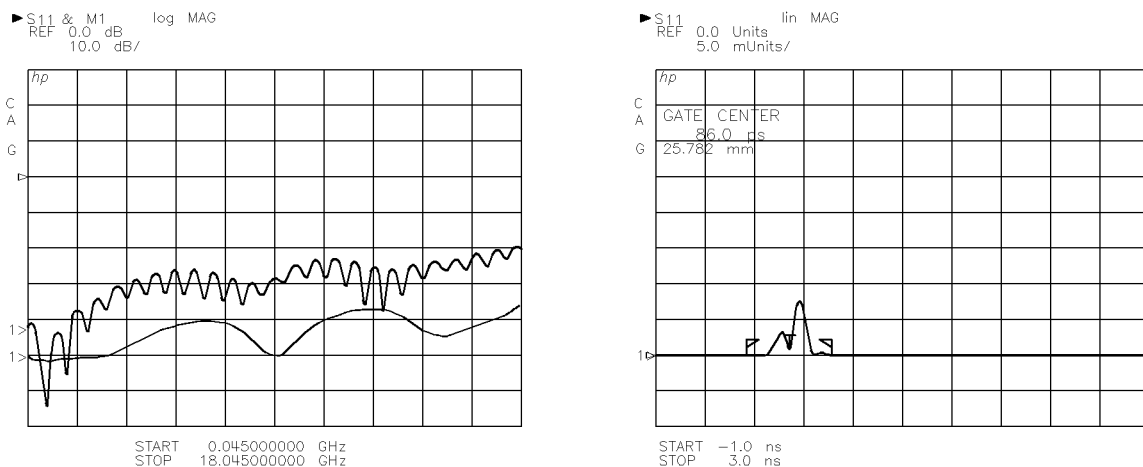

Figure 11-16. Gated Responses of the 7-mm to 3.5-mm Adapter

The smoother trace in the Frequency Domain plot of Figure 11-16 shows the Gated Frequency Domain response, which is that of the adapter only. The effects of the fixed load on the measurement are removed.

Select Gate Shape

Four different Gate shapes are available:

- MINIMUM
- NORMAL
- WIDE
- MAXIMUM

Each of the Gates have different passband flatness, cutoff rate, and sidelobe levels. T_1 indicates the Gate span which is the time between the Gate start and stop indicators. T_2 is the time between the edge of the Gate passband and the -6 dB Gate stop time. T_3 , equal to T_2 , is the time between the Gate stop time and the point where the filter first reaches the level of the highest Gate sidelobe. The Gate characteristics for each Gate shape are listed in Figure 11-17.

Time Domain Concepts

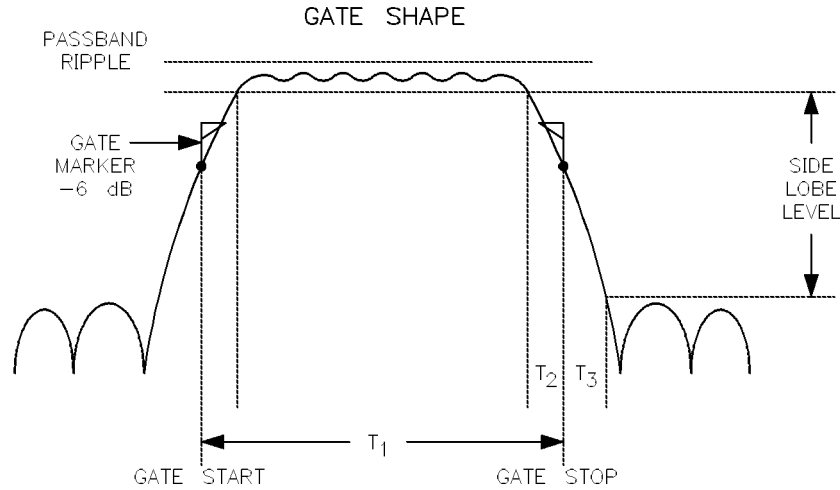

Figure 11-17. Gate Characteristics

The Passband Ripple and Sidelobe Levels are descriptive of the gate (filter) shape. The Cutoff Time, $T_2 = T_3$ (see Figure 11-17), indicates how fast the gate filter rolls off. For each gate shape, there is also a Minimum Gate Span ($T_{1\min} = 2 \times T_2$) which gives a filter passband of zero.

To enter a Gate span smaller than minimum will produce a distorted filter shape that:

- Will have no passband.
- Will not have a narrower shape.
- May have higher sidelobe levels.
- Will give an incorrect indication of gate Start and Stop times.

Therefore, it is important to always select a Gate span that is higher than the minimum value. The cutoff time and the minimum gate span are inversely proportional to the frequency span of the measurement as indicated in Figure 11-17.

For best results using Gating, it is important to always center the Gate around the response(s) that you want to retain in the measurement and to make the Gate span wide enough to include all of those responses. It is also recommended to use the widest Gate shape possible.

Measurement Recommendations

When making Time Domain measurements, it is generally good practice to measure the device within the frequency range that it is designed to operate. There are two reasons for this:

- The noise floor of the Time Domain response is directly related to the noise in the Frequency Domain data. Therefore, if many of the Frequency Domain data points are taken at or below the noise floor of the measurement, then the noise floor of the Time Domain measurement will be increased.
- The in-band response is normally what you want to measure. The Time Domain measurement is an average of the response over the frequency range of the measurement, and if the Frequency Domain data is measured out of band, then the Time Domain measurement will also be the out of band response.

However, since the Time Domain Response-Resolution is inversely proportional to the frequency span, it may at times be desirable (with these limitations in mind) to use a frequency span that is slightly wider than the device bandwidth to give better response-resolution.

Source Considerations

A sweep oscillator or synthesized source will work well in making Time Domain measurements. A synthesizer has the capability of operating in Step sweep mode. The Step sweep mode provides greater dynamic range than Ramp sweep mode. The main reason for this is the frequency stability of a synthesized source. The small nonlinearities and phase discontinuities that occur in the Ramp sweep mode cause low level noise sidebands on the Time Domain Impulse or Step stimulus. These interfere in measurements requiring large dynamic range. Perform a TRIM SWEEP adjustment before calibrating to help minimize these noise sidebands.

In the Step sweep mode, the improvement in source stability eliminates these noise sidebands and improves the Time Domain measurement dynamic range by as much as 30 dB. A second improvement is that the stepped sweep mode allows the use of many averages per point without greatly affecting the sweep time, and this lowers the noise floor of the Time Domain measurement.

Test Set Considerations

Wide frequency range test sets have two advantages over narrow frequency range test sets (when making Time Domain measurements). These advantages assume that the DUT has a bandwidth that is roughly the same as the test set's frequency range.

- The wide frequency range, when measuring broadband devices, provides greater bandwidth and thus better Time Domain Response-Resolution.
- If the test set does not have a flat response down to the Start frequency, then the roll off reduces the dynamic range available at the low frequencies (-30 dB at 45 MHz) and therefore increases the Time Domain noise floor when measurements are made at those frequencies. Assuming that the device under test response is not the limiting factor, this causes the trace bounce in the Time Low Pass Step response.

Power Domain Measurements

Introduction

This chapter explains the function and use of power domain in the Agilent 8510C network analyzer, with firmware revision 7.0 or higher. The following sections explain the concept of power domain, how to set up the 8510C to use power domain, the calibration implications, and limitations, as well as detailed measurement examples.

This chapter also includes a description of Receiver Cal function, which is required to allow calibrated measurements in power domain mode.

What Is Power Domain?

Power domain allows measurements of a device under test, over a power range of interest, at a constant frequency. In contrast, a frequency domain mode measurement measures power over a frequency range of interest. A typical application for power domain is measuring the compression of amplifiers. In power domain, the independent variable (STIMULUS) swept or stepped by the network analyzer system (normally frequency) is changed to power. The STIMULUS block keys (**START**), (**STOP**), (**CENTER**), and (**SPAN**) refer to power and affect the horizontal axis of a rectangular display. A frequency point must be selected, and is displayed beside the range of power.

Without a calibrated receiver (**RECEIVER CAL**) and source flatness calibration (**FLATNESS CAL**), the test port absolute power cannot be known. The power is varied by controlling the Agilent 8360 synthesized source.

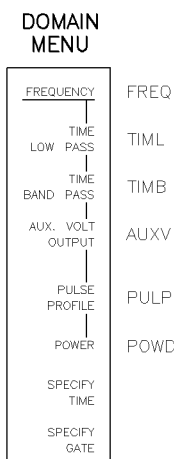

domainmain

Figure 12-1. Domain Menu with Power Domain Function Keys

Power Domain Measurements

What Is Receiver Cal?

The 8510C network analyzer receiver calibration (**RECEIVER CAL**) feature provides a display of unratioed receiver inputs, calibrated in absolute power (usually dBm). The feature is normally used in association with power domain since the power levels displayed are otherwise those determined by the source and do not account for losses in the path between the source and the test ports. Receiver calibration is performed after calibrating the 8360 Series source with a power meter and ensuring that it remains leveled across the frequency range of operation. A receiver calibration is stored as a Cal Set and corrects Port 1 (a1) output power and Port 2 (b2) input power, only.

Note There are a number of assumptions associated with receiver calibration. Specifically, the feature relies on the linearity of the detectors and does not make any correction for mismatches at the test ports.

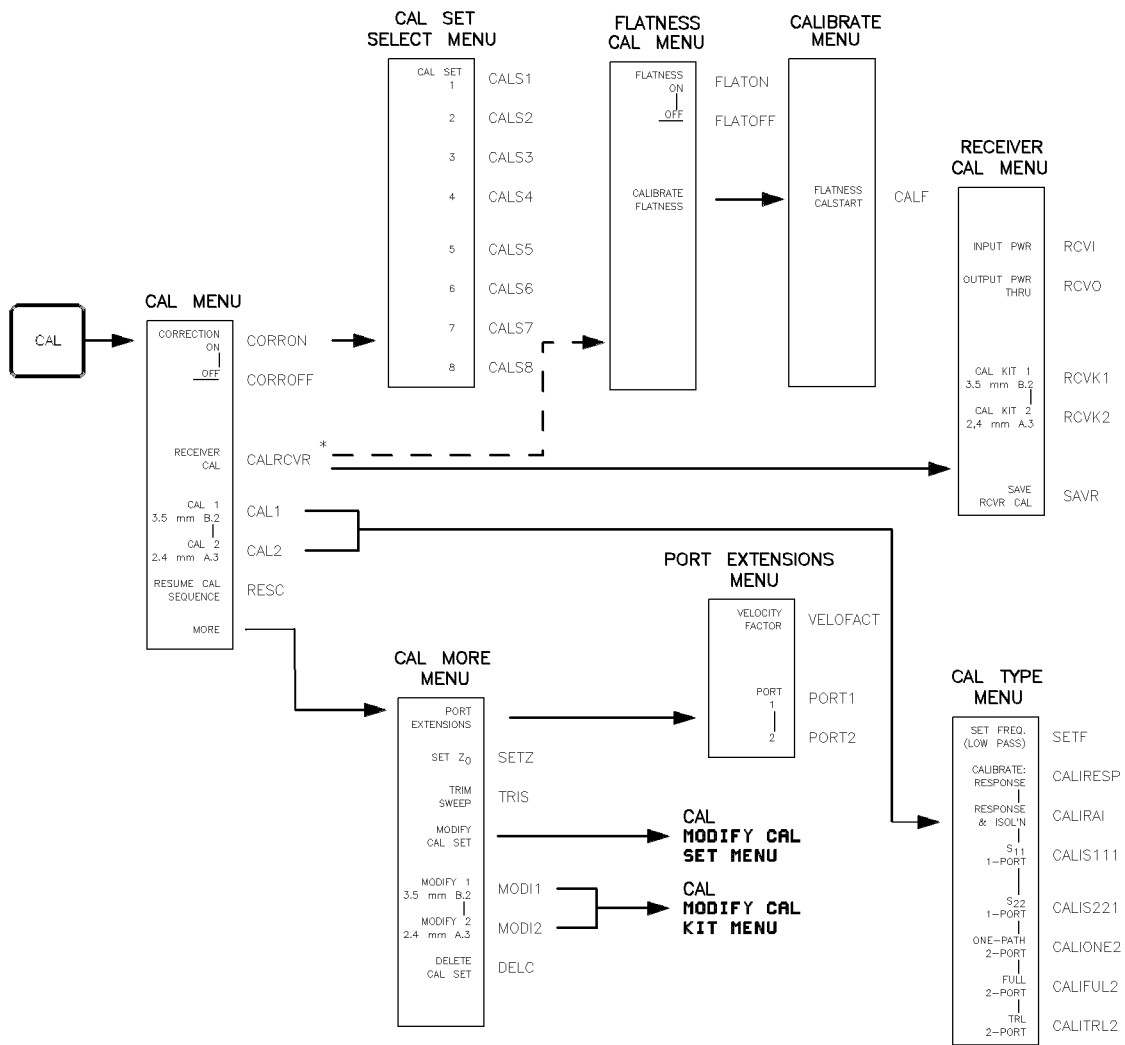

* Attempting to enter the RECEIVER CAL MENU without having completed a FLATNESS CAL will put you into the FLATNESS CAL MENU. This menu actually resides within the Stimulus block, under Menu, Power Menu, and Power Flatness.

calmen1

Figure 12-2. Receiver Calibration Menu

Making a Power Domain Measurement

The 8510C must already be calibrated in the frequency range of choice, or the user should perform the calibration at the beginning of this power domain procedure.

It is recommended that you choose a frequency range that gives frequency steps of a convenient size. Doing so allows the measurement frequencies to be easily recalled later. For example, setting **(START)** to 50 MHz, and **(STOP)** to 5050 MHz, with the number of points set to 101, gives measurement frequencies in even 50 MHz increments.

1. In frequency domain, set the 8510C to the frequency range of interest. Press the appropriate STIMULUS block keys to enter the values (**(START)** and **(STOP)**, or **(CENTER)**, and **(SPAN)**).
2. Press the STIMULUS block **(MENU)** key, then press **STEP** to underline step mode.

Note Step mode is required while using the power domain function. If you calibrate or use a previously stored Cal Set, the power domain frequency of measurement must be a point in the original (frequency domain) calibration.

3. Either calibrate the system at this point, or recall a previously stored Cal Set to use.
4. Activate a marker and set the marker to the frequency at which you wish to make a power sweep. If the marker is not used, the power domain is entered at 2 GHz.

Note If multiple markers are ON, the active marker is used for the power domain frequency of measurement.

5. Press **(DOMAIN)**, **POWER**, then press the appropriate STIMULUS block keys to set the power levels of interest.

Note The default power level values are START equals -10 dBm, STOP equals 0 dBm. The **POWER SOURCE 1** softkey in the STIMULUS **POWER MENU** has no effect in power domain mode. Pressing the key and entering a value displays an error message. When you enter frequency domain mode again, source 1 power is reset to its original value.

6. With the power level set, you may change frequency setting using the **FREQ. of MEASUREMENT** key.
 - a. To choose a calibrated frequency point, use the **NEXT PT HIGHER** or **NEXT PT LOWER** keys.
 - b. Select a valid (calibrated) frequency value. Notice that as you change frequencies, the trace changes as the calibration is first turned *OFF*, then back *ON* again.

Power Domain Measurements

Note When in power domain mode, you may use only one Cal Set for 4-parameter display. If power domain is selected with more than one Cal Set applied, then the active parameter calibration is converted to power domain and applied to the measurements. All others are reset. Dual channel display may be used to view power domain data and frequency domain data simultaneously, however, **UNCOUPLED CHANNELS** must first be selected.

Performing a Receiver Calibration

1. Set the 8510C system to Frequency Domain and set the frequency range of interest.
2. Select the desired number of points to measure. If you plan to use power domain, **STEP** sweep mode must be selected.
3. Set the source power level.
 - a. Press the 8510C STIMULUS block **(MENU)** key.
 - b. Press **POWER MENU**, then press **POWER SOURCE 1**.
 - c. Adjust the source power to a value appropriate for the device under test.

If you have carried out a power flatness calibration since cycling the system power, skip to Step 5, otherwise, continue with the flatness calibration at Step 4.

The Flatness Calibration Must Be Completed

Flatness calibration must be completed before beginning the receiver calibration. Data obtained during the flatness calibration is used during the receiver calibration.

4. Connect the power sensor from a zeroed power meter to Port 1 of the test set.
 - a. Press the STIMULUS block **(MENU)** key, then press the following keys:
 - POWER MENU**
 - POWER FLATNESS**
 - CALIBRATE FLATNESS**
 - FLATNESS CAL START**
 - b. Wait until the completion message is displayed before continuing.

Note The source must remain leveled during the flatness calibration process. Calibration fails and displays an error message if the source is unleveled at any frequency. Refer to *Product Note 8510-16* for a complete description of the flatness correction feature.

- c. Remove the power sensor from Port 1 of the test set.
5. Perform the receiver calibration. If valid power flatness data is not available, the system requires that a flatness calibration be completed. Return to Step 4, above.

Power Domain Measurements

6. Connect a thru between Port 1 and Port 2 of the 8510C. It is not necessary for the thru to be zero length or lossless, but should be appropriately defined in the selected Cal Kit.
7. In the MENU block, press **CAL**, then press **RECEIVER CAL**.
 - a. Press **INPUT PWR** to measure power at Port 1. The softkey label is underlined after the measurement is completed.
 - b. Press **OUTPUT PWR** to measure power at Port 2. If several THRU's have been defined in the Cal Kit, a further menu appears to allow selection of the appropriate standard. At the completion of the measurement, the **OUTPUT PWR** key is underlined.
 - c. Press **SAVE RCVR CAL**, then select a Cal Set number and store the receiver cal data.

Note Unless both input and output power have been measured, pressing **SAVE RCVR CAL** generates an error message.

When Receiver Cal is turned on, parameter **User 1 a1** displays input power (**P_{in}**) in dBm and **User 2 b2** displays output power (**P_{out}**). Note that once calibrated, the measurements are valid even if the source power level is changed and whether flatness is turned ON or OFF.

Swept-Frequency Gain Compression Measurement Exercise

Making a swept-frequency gain compression measurement requires the receiver calibration feature to obtain the output power at the desired compression level, in absolute power units.

1. Set the 8510C to the frequency range of interest.
2. Set the power to a value low enough to avoid driving the device under test (DUT) into compression.
3. Perform a receiver calibration as appropriate. Then connect the (DUT).
4. Display S_{21} and perform an S_{21} Response Cal (Thru) with the DUT in place.
5. Press **SCALE** **1** **x1** for convenient viewing.
6. Select split channel display mode.
 - a. Press **DISPLAY**, then **DISPLAY MODE**.
 - b. Select either **DUAL CHAN SPLIT** or **DUAL CHAN OVERLAY**.
 - c. Press **CHANNEL 2**, **PARAMETER** **MENU**, then **USER 2 b2**.
 - d. Confirm that the display on Channel 2 reads **Pout** in units of dBm.
7. Press **CHANNEL 1**, and increase the source power until the gain (S_{21}) decreases to -1 dB at any frequency point.
8. Press **MARKER** and set the marker to the frequency point at which S_{21} is -1 dB.

Note Marker search may be used by pressing **MARKER**, **MORE**, and **MINIMUM**.

9. Read the absolute power at the output from the marker readout for Channel 2.

Swept-Power Gain Compression Measurement Exercise

Making a swept-power gain compression measurement requires using the power domain and receiver calibration features.

1. Set up the 8510C for this measurement as for the “Swept-Frequency Gain Compression Measurement Exercise” above.
2. Ensure that a receiver calibration has been completed, and an appropriate calibration for S_{21} is done (a response cal is usually adequate for well-matched amplifiers).
3. Connect the DUT and display S_{21} on Channel 1 with calibration turned ON.
4. Display a1 (Pin) or b2 (Pout) on Channel 2. Turn on the previously stored Cal Set having a receiver calibration.
5. Set a marker to the desired frequency of measurement for Power Domain.
6. Select Power Domain. Press **DOMAIN**, then **POWER**.
7. Set the start- and stop-power points to values that drive the amplifier into compression during the trace.
8. Use the marker search function to locate a gain drop of 1 dB on the S_{21} trace.
9. Read the marker value for Channel 2 to determine the absolute input power (Pin) or output power (Pout) at the 1 dB compression point.
 - a. Press **CHANNEL 2**, then **MENU** in the PARAMETER block.
 - b. Press **USER 1 a1** or **USER 2 b2**.
10. To make calibrated compression measurements at other frequencies of interest, use the steps that follow:
 - a. Press **DOMAIN**, **POWER**, then **NEXT PT HIGHER** or **NEXT PT LOWER** to select the next point from the original frequency domain calibrations.
OR
Enter a valid frequency of measurement using the numeric keypad. This method may be used provided the exact frequency point entered is contained in the original frequency domain calibration. Press **DOMAIN** **POWER**, then **FREQUENCY OF MEAS.** and enter the valid frequency.

Note Entering a frequency of measurement not contained in the original frequency domain calibration causes the calibrations to be turned OFF.

- b. Repeat steps 8 and 9 above for the new frequency of measurement.

GPIB Programming

This chapter explains how to automate measurement and data processing operations using the network analyzer system with an external controller over the General Purpose Interface Bus (GPIB). Programming information in this section is not comprehensive. Refer to the *Agilent 8510C Network Analyzer System Keyword Dictionary* for details of each function. The instructions assume you are familiar with manual operation of the network analyzer system, and that you have read the “Basic Network Measurements” section in this manual. Details of each function are given only if these are unique to programmed operation or are different for manual and programmed operation.

What’s in This Chapter

- What You Can Do with Remote Programming
- GPIB Command Information
- Setting up the System
- Transferring Data out of the Network Analyzer
- Using the Data
- Transferring Data into the Network Analyzer
- Commonly Used Queries
- Local Operation
- Programming Examples
- General GPIB Programming
- BASIC Program Listing

What You Can Do with Remote Programming

When you connect an external computer to the network analyzer GPIB interface, you can:

- Change instrument settings or set up measurements.
- Transfer data to or from different stages of internal data processing.
- Control instruments connected to the system bus through the network analyzer.
- Use the network analyzer LCD/CRT as a graphics display.

GPIB Command Information

Programming Command Sequence

Use standard GPIB protocol to program the system state. In most cases, you will use the same sequence as you do when you press network analyzer front-panel hardkeys and softkeys. From the computer, the network analyzer system functions as a single instrument, just as the various instruments that make up the system are controlled using the network analyzer front-panel controls.

Syntax Requirements

Mnemonics may be written using all uppercase characters (for example, **STAR**;)); this is the preferred syntax. You may also write mnemonics with an initial capital letter followed by lowercase (for example, **Star**;))

The network analyzer accepts syntax with extraneous blanks; however note that spaces are NOT allowed within the mnemonic name. For example, the mnemonic name **MARK 1** in a statement would cause a syntax error, but **MARK1** would not.

Use the semicolon (;) to separate instructions. Use the comma (,) to separate each value in a series.

If no units terminator follows the value for frequency and time units, the system defaults to network analyzer basic units (Hz, seconds). For other quantities (power, length), a units terminator is not used.

Entering Mnemonics

The program code for each function is a four- to eight-character mnemonic version of its key label. Many mnemonics must be followed by a numeric value in the basic measurement units. For example, the **STIMULUS** **START** key is programmed using **STAR**. Programming mnemonics for all network analyzer front panel controls and menu softkeys are given in the *8510C Network Analyzer System Keyword Dictionary*.

Strings of commands are written in logical sequences separated by a semicolon. For example:

```
OUTPUT 716;"FACTPRES;STAR 2E9;STOP 18E9;S11;LIMP;MARK1 9E9;"
```

This series of command mnemonics executes a factory preset, selects a 2 GHz to 18 GHz sweep, displays S11 using the polar format, then positions measurement marker #1 at 9 GHz. Notice that the values are in units raised to a power of 10. **MARK1 9E9** means to place marker #1 (**MARK1**) at 9 GHz (9×10^9). The **E** represents "raised to the power of."

Using Numeric Entries and Units

Numeric entries without a units terminator are equivalent to pressing the **(X1)** key in the entry area. Rather than using the “E” exponent system, you can enter the actual units for frequency, time, or voltage. For example:

```
OUTPUT 716;"FACTPRES; STAR 2 GHz; STOP 18 GHz; S11; LIMP; MARK1 9 GHz;"
```

Frequency: Use GHz, MHz, and kHz. No terminator is required for Hz units.

Time: Use fs, ps, ns, us, and ms. No terminator is required for seconds.

“Next Menu” Commands Are Unnecessary

Certain functions must be programmed in strict order, but it is not necessary to program a key whose only function is to present a new menu. For example, you can set marker 2 to minimum trace value with the sequence:

```
"OUTPUT 716;MARK2; MARKMINI;"
```

These are the only commands you need, even though the front panel key sequence is:

(MARKER)

MARKER 2 MORE

MARKER TO MINIMUM

You do not need to program the **(MARKER)** hardkey or the **MORE** softkey (in fact, there are no GPIB mnemonics for these keys).

Timing Considerations

In general, timing considerations are handled automatically and data is not displayed until it is valid. However, depending upon the speed of the computer, the programmer may need to intervene to make certain that the data is ready.

The **SING;** and **NUMG;** instructions always hold off execution of the instructions that follow until the specified number of groups is finished. These statements are the primary means of data synchronization. For example, in the sequence:

```
"CHAN1; TIMB; SING; OUTPDATA;"
```

the **SING;** instruction holds off execution of any following instruction, **OUTPDATA;** in this case, until a sweep is finished and the data is ready.

In addition, the output instructions (**OUTPMARK;** and **OUTPACTI;**) are always held off until all preceding instructions are completed. For example:

```
"LOG MAG; MARK1 9 GHz; OUTPMARK;"
```

In this sequence, the marker data is not made available until the format change has been executed and the marker has been positioned. Likewise, operations such as **AUTO;** **MARKMAXI;** **MARKMINI;** and **EQUA;** are held off until all preceding instructions are completed.

However, for the array output statements (**OUTPRAWn;** **OUTPDATA;** **OUTPFORM;** **OUTPMEMO;** and **OUTPCALCn;**) the data is always made available immediately without regard to operations that may be in progress, except for **SING;** and **NUMG;**. For example, in the sequence **"TIMB; OUTPDATA;"** the instruction **TIMB** performs a time domain conversion, this requires a certain

GPIB Programming Basics

length of time. Execution of `OUTPDATA;` is not delayed until the conversion is finished. Thus, the data that is output probably is not the actual converted data (depending upon the speed of the computer), but the data that existed before the domain conversion.

If you don't want or need to take new data, and you change the channel or domain immediately before requesting data output, use the `WAIT;` instruction. Use `WAIT;` at any time, to make certain that the instruction immediately before `WAIT;` has finished before the instruction that follows `WAIT;` begins execution. So, for the time domain conversion example, use a sequence such as:

```
"TIMB; WAIT; OUTPDATA;"
```

This assures that the conversion is finished before the data is made ready for output.

Overview of Computer-Controlled Measurements

In a typical computer-controlled measurement, you will:

- Set up the system for a particular measurement.
- Perform an appropriate measurement calibration for each parameter to be measured.
- Save the calibration in a cal set memory location.
- Install the test device and measure its response; the network analyzer applies calibration offsets to the data.
- Output the data from the desired array to the computer.

The stimulus settings and parameter used during the calibration must match those used during the calibrated measurement. Cal sets remember the stimulus settings that were in effect when the calibration was made. When you recall a cal set, it automatically changes the stimulus settings accordingly. The cal set does not remember any non-stimulus settings.

Setting Up the System

Connect the External Computer

Connect the computer to the main GPIB connector. Connect RF sources to the system interconnect. You must not connect the same device to the GPIB connection and system bus at the same time!

Address Settings

Instrument interconnections and the GPIB system bus address settings in the network analyzer system are shown in Chapter 2, "Introductory Measurement Sequence."

The network analyzer's system bus uses two-digit GPIB addresses to control instruments and peripherals connected to it. To change these addresses, use the menu under the network analyzer's front panel `(LOCAL)` key (the same menu is available under `(SYSTEM) HP-IB ADDRESSES`).

Set Up the Measurement Using GPIB Commands

Set up the measurement using GPIB Commands, following the guidelines discussed in “GPIB Command Information”. A typical setup command string is:

```
OUTPUT 716;"FACTPRES;STAR 2E9;STOP 18E9;S11;LINM;MARK1 19E9;"
```

This command string:

- Performs a factory preset (which selects frequency domain and step sweep mode)
- Sets start frequency to 2 GHz
- Sets stop frequency to 18 GHz
- Selects S11
- Selects linear magnitude display format
- Puts a marker at 19 GHz

Refer to the *8510C Network Analyzer System Keyword Dictionary* for additional commands. If you do not know the command for a specific function, look at the “Menu Structures” chapter in the keyword dictionary. This section has fold-out pages showing all menu maps, each softkey function, and the GPIB mnemonic for each softkey.

Transferring Data out of the Network Analyzer

Sending Data to the Computer

You can send measurement data to the computer in either of two ways:

- You can output the current-active marker value.
- You can output a complete data trace.

Before you attempt to transfer data to the computer, you should know:

- Which network analyzer data arrays you can transfer
- Which instrument features affect each data array
- Which of the five data transfer protocols (formats) you should use

What Types of Data Are Available from the 8510C?

After making a measurement, you can send **raw**, **corrected**, or **formatted** measurement data to the computer. These arrays represent different stages of data processing, illustrated in Figure 13-1.

As explained next, there are specific GPIB commands used to transfer each type of data array.

GPIB Programming Basics

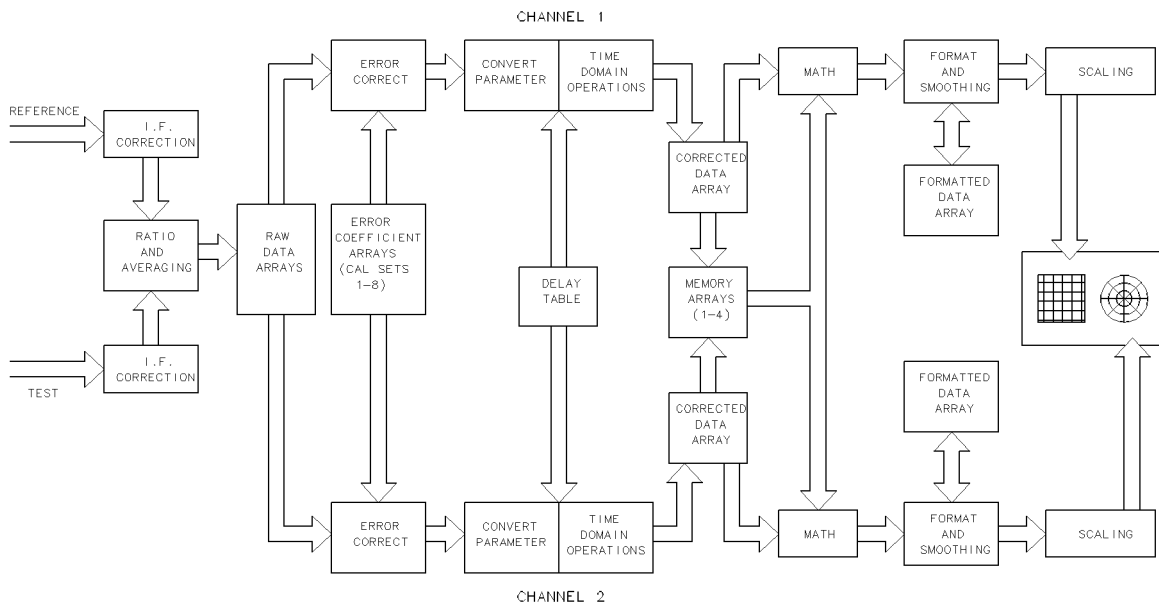

Figure 13-1. Data Processing Stages in the Network Analyzer

Data Arrays Read by an External Computer

Raw Data

This data array contains the ratioed and averaged measurement data results.

Note In fast CW mode, raw data is the only available format.

To transfer the data from this array to the computer, use the GPIB command `OUTPRAW n` , where n is the desired S-parameter (S11, S21, S12, S22). Refer to the *8510C Network Analyzer System Keyword Dictionary* for syntax and other information about `OUTPRAW n` and other commands. The raw array data is in real/imaginary pairs.

Raw data can be output for any parameter at any time, assuming the parameter is actually being measured. If a parameter is displayed on the screen, it is being measured by the network analyzer. Or, when a full 2-port calibration is active, all four S-parameters are measured.

Corrected Data Array

In addition to ratioing and averaging, corrected data has been through:

- Time domain
- Calibration
- Table delay, electrical delay
- Magnitude offset

Remember that these features must be active to affect the data. To transfer data from the corrected data array to the computer, use the GPIB command `OUTPDATA`. Although you can select any raw data array for transfer, you cannot do this with the corrected data array.

13-6 GPIB Programming

Instead, `OUTPDATA` outputs the data for the active parameter only. The corrected data array is in real/imaginary pairs.

Formatted Data Array

This data has had all the data processing of the raw and corrected data arrays, plus smoothing, formatting, and trace math processing. To transfer data from this array to the computer, use the GPIB command `OUTPFORM`. This command outputs the data for the active parameter only.

The data format that you get out of the formatted array depends on the display mode you are using:

- If you are in a polar display mode, the formatted array will output real/imaginary data pairs.
- If you are in a Cartesian magnitude display mode, a data pair will be output. The first value will be magnitude data. The second value output is always zero. The units will match those you selected for the display (dB or linear).
- If you are in Cartesian phase display format (`(PHASE)`), a data pair will be output. The first value will be phase (in degrees). The second value output is always zero.

Calibration Coefficients These are the error correction coefficients created during calibration (also called a “cal set”). The error coefficient arrays can be read from or sent to a computer, just like the arrays described above. Refer to the descriptions for the `OUTPCALC` and `INPUCALC` commands in the *8510C Network Analyzer System Keyword Dictionary*.

Delay Table Each parameter has its own special array called a “delay table.” The table must be created using an external computer, then be sent to the network analyzer. The network analyzer uses the table to modify measurement data. The table contains real/imaginary data pairs in the internal FORM1 compressed format. A typical use is to modify frequency domain data to synthesize a special window shape for use in time domain measurements. Refer to the descriptions for the `OUTPDELA` and `INPUDELA` commands in the *8510C Network Analyzer System Keyword Dictionary*.

Memory Data Valid data can be read from this array *if* data has been stored to memory. Refer to the descriptions for the `OUTPMEMO` command in the *8510C Network Analyzer System Keyword Dictionary*. (There is no command to send data directly into memory from the computer. However, you can send data to the raw or corrected array, then save it to memory using `DATI`.)

A trace currently stored in one of the eight trace math memories may be output by selecting the memory, using one of these mnemonics:

- DEFM1; to select Memory 1
- DEFM2; to select Memory 2
- DEFM3; to select Memory 3
- DEFM4; to select Memory 4
- DEFM5; to select Memory 5
- DEFM6; to select Memory 6

GPIB Programming Basics

DEFM7; to select Memory 7

DEFM8; to select Memory 8

First select the memory using the DEFM n ; instruction, turn on memory by issuing a DISPMEMO; instruction, then use OUTPMEMO; to read currently selected memory. This transfers the memory data in real/imaginary pairs.

Data Always Comes from the Active Channel

Notice that there are two entirely different, parallel, data processing paths shown in Figure 13-1. One path is for Channel 1 and one is for Channel 2. Each channel has raw, corrected, and formatted data arrays. Because the paths are separate and independent, different features can be active for Channel 1 and OFF for Channel 2. As you have seen, the GPIB transfer commands let you select the S-parameter (S11, S21, S12, or S22) for data transfer. But since each channel has four independent parameters, the data transfer always occurs on the active channel.

Available Data Transfer Formats

In remote programming, you can choose one of four *binary* data formats, or an *ASCII* data format.

Use the descriptions of each form to decide which transfer format is appropriate for your needs. Specific information about byte sizes and structure of these formats is provided in “Preparing the Computer to Transmit or Receive Data”, later in this chapter; and also in the *8510C Network Analyzer System Keyword Dictionary*.

Form 1 (GPIB Command: FORM1) FORM1 is significantly different from the other four transfer modes. The biggest difference is that you can only obtain data from the raw array when you use FORM1. The other four transfer modes let you choose any internal data array for transfer.

FORM1 is the fastest transfer format available and is almost exclusively used in fast CW mode. Refer to “FORM 1” in the *8510C Network Analyzer System Keyword Dictionary* for a full description of this transfer format. FORM1 data can be converted to floating point data in the computer. FORM1 is the *only* transfer format you can use for fast CW mode.

Form 2 (GPIB Command: FORM2) 32-bit IEEE 728 floating point format. This format is not commonly used. It consists of a header, a two-byte number indicating how many bytes follow, then the real and imaginary data pairs for each stimulus point.

Form 3 (GPIB Command: FORM3) This is the recommended format for use with HP 9000 Series 200/300 workstations. It consists of a header, a two-byte number indicating how many bytes follow, then the real and imaginary data pairs for each stimulus point. FORM3 follows the 64-bit IEEE 728 standard format.

Form 4 (GPIB Command: FORM4) This format is ASCII and is not as commonly used as other formats because it is relatively slow. However, even with this limitation there are still two circumstances in which FORM4 is useful:

- When first learning how to transfer data. FORM4 comes out in ASCII format that is meaningful to a human being.

- When using GPIB cards of limited ability. Some third party GPIB (IEEE 488-2) cards (for PC compatibles) requires ASCII format data.

Form 5 (GPIB Command: **FORM5**) This is the recommended format for use with IBM PCs and compatibles. This is a 32-bit DOS-compatible floating point format.

The *8510C Network Analyzer System Keyword Dictionary* describes each form in detail. It also describes the component pieces of information that accompanies the data.

The following example shows the data transfer to the computer when **FORM3** is selected:

```
ASSIGN @Nwa to 716; FORMAT OFF
OUTPUT @Nwa; "FORM3; SING; OUTPDATA"
ENTER @Nwa_data; Preamble, Size, Data(*)
```

Use **NUMG**; or **SING**; to synchronize data output with completion of data acquisition. The variable **Preamble** accepts the **#A** block header, the variable **Size** accepts the value representing the total number of data bytes in the block, and the variable **Data(*)** accepts the real/imaginary data pairs.

If **Data(*)** is dimensioned to less than the number of points currently selected, then the **ENTER** operation does not terminate. You may issue another **ENTER** statement to read the remaining data, or send another network analyzer command (such as **ENTO**;) to terminate the network analyzer data output mode.

How Much Data Is Transferred?

When you measure data, the network analyzer stores data for the entire sweep in the raw, corrected, and formatted arrays. In addition, data for all displayed parameters are stored in these arrays. For example, if you have selected 201 frequency points, each array contains 201 data points. If more than one parameter is displayed, a complete set of data exists for each one.

When you transfer raw data, the entire array for the selected S-parameter (S11, S21, S12, or S22) is sent to the computer.

When you transfer corrected data or formatted data, the entire array for the active parameter is sent to the computer.

Preparing the Computer to Transmit or Receive Data

Setting up the I/O Path

If you are using BASIC, the **ASSIGN** command sets up the I/O path and its attributes. **FORM1** requires the **FORMAT** attribute to be turned OFF (**FORMAT OFF**) in the assign statement. All other data formats (**FORM2** through **FORM5**) require the format attribute to be ON (**FORMAT ON**). This type of data format (**FORM1** through **FORM5**) transfers data in three portions, each of equal size (mentioned below).

The entire data block to be transferred is composed of:

- A “preamble” or “header” block, composed of the characters **#A**. All forms have this header block except **FORM4**, and **FORM1** when in the fast CW modes.
- A size block. This block contains the size (in bits), of the preamble, the size block itself, and each data block. All forms have this header block, except **FORM4**.

GPIB Programming Basics

- One data block for each point in the measurement. Each block contains one data pair. FORM4 contains only data blocks.

Size of the Preamble, Size Block, and Data Blocks

In FORM1 each block is 16 bits long (2 bytes per data point).

In FORM2, each block is 32 bits long (8 bytes per data point).

In FORM3, each block is 64 bits long (16 bytes per data point).

FORM4 is an ASCII format, which contains only data blocks, each of which being 24 bytes long. Each of these blocks contain a data pair, in which the two numbers is separated by a comma. Each block is separated by a line feed.

In FORM5, each block is 32 bits long (8 bytes per data point).

Setting Up Variables

Unless you are using FORM4, you must set up an integer variable for the preamble and the size block. Dimension an array of appropriate size for the data. FORM4 data requires a string array.

Dynamic Array Allocation

Setting up fixed array sizes is all you may need in simple programs. However, large measurement programs may need to call subroutines that can intelligently determine the size of the required data array. Fortunately, you can write your program so it reads the size block, then dynamically allocates the required data array storage, as in this sequence:

```
OUTPUT @Nwa; "FORM3; SING; OUTPDATA"  
ENTER @Nwa_data; Preamble, Size  
N=Size/16 ! 16 bytes per data point using FORM3  
REDIM Data(1:N, 1:2)  
ENTER @Nwa_data; Data(*)
```

You can do the same thing by making the number of points the active function then reading the value, as in this sequence:

```
OUTPUT @Nwa; "POIN; OUTPACTI;"  
ENTER @Nwa; Points  
REDIM Data(1:Points, 1:2)  
OUTPUT @Nwa; "FORM3; OUTPDATA;"  
ENTER @Nwa_data; Preamble, Size, Data(*)
```

All transfers use standard IEEE 728 block transfer formats with EOI asserted with the last byte of data.

Performing the Actual Transfer

Now that you know which data array and transfer format to use, and have dimensioned appropriate computer variables and an array, you are ready to perform the actual data transfer. Refer also to programming examples 6 and 7 later in this chapter.

An Example of a Data Transfer

The following BASIC example performs a data transfer, and demonstrates many commonly-needed tasks:

- Measurement setup
- Data acquisition
- Conversion of real and imaginary data into magnitude and phase format
- Printout of the values for each point

This example is complete. It dimensions all needed variables, shows all GPIB bus “maintenance” commands, and so on. If you are not using BASIC, you need to write the necessary lines of code for I/O setup. BASIC has advanced I/O features and requires the ASSIGN command only for this.

The sample measurement uses 201 points of data. All loop counters and arrays are written to handle 201 points. Step sweep mode is used, with a single sweep. The example uses FORM3 transfer, but is applicable to FORM2 or FORM5 by changing line 39 to the correct FORMn.

```

1   OPTION BASE 0           !Set loop and array counting at the number 0
3   DIM Data(200,1)        !Dimension a 201 x 2 array to hold transferred data.
5   DIM Mag(200),Phase(200) !Dimension two 1-dimensional arrays to hold the
7   !final magnitude and phase values for each point.
9   INTEGER Preamble,Size  !Define integer variables for the preamble and
11  !size blocks.
13  ASSIGN @Nwa TO 716      !This sets up the I/O path for the network analyzer, and
15  !defines the GPIB address used to talk to it.
17  !
19  ASSIGN @Nwa_data2 TO 716;FORMAT OFF!
21  !
23  CLEAR 716              !
25  OUTPUT @Nwa;"USERPRES;" !Tells the network analyzer to do a user preset.
27  DEG                    !BASIC command to express angles in degrees
29  !rather than radians.
31  !
33  !The next line selects 201 points, S11, log magnitude display
35  !Log Format, Single Sweep, FORM3:
37  !
39  OUTPUT @Nwa;"POIN201;S11;LOGM;SING;FORM3;"
41  !
43  OUTPUT @Nwa;"OUTPDATA;" !Tells the network analyzer to output the entire
45  !Calibrated array (201 points)
47  !
49  ENTER @Nwa_data2;Preamble,Size,Data(*)!Tells the computer to store:
51  !the Preamble in the "Preamble" variable
53  !the Size block in the "Size" variable
55  !All data in the "Data" array
57  !
59  FOR N=0 TO 200         !Start a for/next loop (loops 201 times)
61  Real=Data(N,0)         !These two lines grab the first data point out
63  Imag=Data(N,1)         !of the array (starts with the start frequency point)
65  !
67  !Convert one point of data from real/imaginary to magnitude/phase
69  !
71  Mag(N)=SQR(Real^2+Imag^2) !Determine magnitude value
73  IF Imag=0 AND Real<0 THEN !Determine phase value

```

GPIB Programming Basics

```
75     Phase(N)=-180
77     ELSE
79         IF Imag=0 AND Real=0 THEN
81             Phase (N)=0
83         ELSE
85             Phase(N)=2*ATN(Imag/(Real+Mag(N)))
87         END IF
89     END IF
91     !
93     !Mag(N) and Phase(N) are 1-dimensional arrays that will hold the new
95     !magnitude and phase data.
97     !
99     !
101    !The following two lines simply print the real, imaginary, magnitude and
103    !phase values for the first point and every 20th point.
105    !
107    IF N=0 OR N/20=INT(N/20) THEN
109        PRINT "Point: ";N+1;TAB(13);"Real: ";Real;TAB(36);" Imag: ";Imag
111        PRINT "Point: ";N+1;TAB(13);" Mag: ";Mag(N);TAB(36);"Phase: ";Phase(N)
113    END IF
115    !
117    NEXT N
119    !
121    OUTPUT @Nwa;"Mark1;"
123    LOCAL 716                !Place network analyzer back in local mode
125    END
```

Using the Data

The 8510C outputs data in two basic formats:

- FORM1 format
- Real/imaginary format

Use the following information to process the data into usable formats.

Preprocessing FORM1 Data

Example 7 converts FORM1 data into real/imaginary pairs, which are then converted into linear magnitude, log magnitude, and phase data.

Using Real/Imaginary Format for Vector Math

Real and imaginary data in its existing form is useful for vector math. Once you have done any mathematical processing of the data, you can convert it into magnitude and phase information as explained below.

Converting Real/Imaginary Data to Magnitude and Phase Data

As explained earlier in this chapter, data is often in real/imaginary data pairs. You can perform vector math on this data directly, or you can convert it into magnitude and phase information (refer to lines 71 through 81 in “An Example of a Data Transfer”).

Transferring Data into the Network Analyzer

Raw, Corrected, Formatted Arrays

Load trace data into network analyzer memory using hold mode. Hold mode avoids overwriting the loaded data with newly acquired data. When hold mode is selected, completion of a data input operation initiates a data processing cycle in which the displayed trace is updated to reflect the new data. The following mnemonics prepare the network analyzer to transfer data pairs at the network analyzer GPIB to the specified array for the currently selected channel:

INPUFORM; load into selected channel formatted data array
INPUDATA; load into selected channel corrected data array
INPURAW1; load into selected channel S11 raw data array
INPURAW2; load into selected channel S21 raw data array
INPURAW3; load into selected channel S12 raw data array
INPURAW4; load into selected channel S22 raw data array

INPUDATA; and INPURAW n ; expect data in real/imaginary pairs regardless of the currently selected display format.

Each display S-parameter (S11, S21, S12, S22) has its own raw array, corrected array and formatted array. In addition, each channel has an independent set of four parameters, each with its own raw, corrected, and formatted arrays.

When you perform an INPUDATA; command, the data is placed in the corrected array for the active parameter on the active channel. INPUFORM; works the same way.

With raw data, there is a different GPIB command for each raw data array (INPURAW1; through INPURAW4;). When you issue an INPURAW3; command, data is sent to the S12 raw data array in the active channel.

INPUFORM; requires you to supply data in exactly the same format as the network analyzer would use during an OUTPFORM operation. (As explained earlier, when you output data from the formatted array, the exact form of the data depends on the domain the network analyzer is in, and the selected display format. Depending on these conditions, the network analyzer *outputs* data in a specific way. This is explained in “Formatted Data Array,” earlier in this chapter. When you use INPUFORM;, you must make sure you send the data to the network analyzer in the same way the network analyzer would use if it were sending the data to the computer.)

Note

You cannot send data to an array if that parameter is not displayed on the screen. When a parameter is shown on the screen, it is essentially turned ON. If a parameter is not on the screen, it is OFF. Usually, you cannot perform functions (of any kind) on a parameter that is not currently shown on the screen. This limitation applies to sending data to the various arrays.

For example, to send data to the corrected array of S22, one of the following must be true:

- SINGLE PARAMETER display mode is selected, and S22 is the selected parameter.
- FOUR PARAMETER display mode is selected, and S22 must be the active parameter.

Trace Memories

First, use one the following commands to select the trace memory to be loaded:

```
DEFM1; select Memory 1
DEFM2; select Memory 2
DEFM3; select Memory 3
DEFM4; select Memory 4
DEFM5; select Memory 5
DEFM6; select Memory 6
DEFM7; select Memory 7
DEFM8; select Memory 8
```

Next, load data into the corrected data array, using:

```
"INPUdata;"
```

Finally, store the data into the selected memory, using:

```
"DATI;"
```

The data format for these transfers is selected by the **FORM1**, **FORM2**, **FORM3**, **FORM4** and **FORM5** mnemonics as for the **OUTP** instructions. One of the **FORMn** instructions should precede each transfer.

This example shows the data transfer from the computer to network analyzer corrected data array for the currently selected channel using **FORM3**.

```
OUTPUT @Nwa; "HOLD; FORM3; INPUdata;"
OUTPUT @Nwa; Preamble, Size, Data(*)
```

HOLD prevents overwriting the data just input with data from the next group of sweeps. The variable **Preamble** holds the **#A** block header, the variable **Size** holds the value representing the total number of data bytes in the block, and **Data(*)** holds the real/imaginary data pairs.

The network analyzer accepts data until the specified number of bytes is received, or **EOI** is detected, then terminates the listen mode. If the number of data bytes is not equal to the value of the variable **Size**, the message **BLOCK INPUT ERROR** is displayed. If the value of the variable **Size** does not correspond to the current number of points selected, the message **BLOCK INPUT LENGTH ERROR** is displayed. If more than the internally allocated number of bytes are input, these bytes are treated like regular commands, which causes a syntax error. If less than the specified number of bytes are input without an **EOI**, you may continue with another **OUTPUT** statement.

FORM4 Input

When using **FORM4**, always suppress the **CR/LF** which would normally terminate the **OUTPUT** statement that sends the **INPU** instruction as follows.

```
OUTPUT @Nwa; "HOLD; FORM4; INPUdata;";
OUTPUT @Nwa; Data(*)''
```

The semicolon following the last quotation mark in the first line is used in **BASIC** to suppress the normal **CR/LF**. Failure to suppress this character results in the network analyzer accepting the **CR/LF** as the first data byte.

Commonly-Used Queries

Marker Value

The marker value is output as two ASCII numbers in the basic units for the selected display format. Use two real variables. For example:

```
Mag,Phase
```

If the marker value consists of a single value, as when LOG MAG (**LOGM;**) or PHASE (**PHAS;**) is selected, then the first number becomes the desired value (magnitude or phase) and the second value is set to zero.

Active Function Value

The current value of the active function is read as a single ASCII number in the basic units for the quantity. The following sequence turns on marker 2, moves the marker to the maximum value on the trace. Then **OUTPACTI** readies the network analyzer to output the current active function, which is the stimulus value at the marker position in the sequence:

```
"MARK2; MARKMAXI; OUTPACTI;"
```

To accept the data, use a single real variable. For example:

```
Freq
```

Query System State

For instrument state settings that cannot be made the active function, use the query instructions function. For example:

```
DOMA?
```

This command returns the current domain selection as an ASCII string enclosed as quotes, for example **"FREQUENCY"** if the frequency domain is currently selected.

System Status

Important system status information is available by reading a two-byte status word. For example,

```
"OUTPSTAT;"
```

This command sets up the network analyzer to output the status value so you can read one or two ASCII numbers. A change in the status bytes can be set to generate the SRQ on specific events using the **SRQM** instruction.

The following instruction outputs a single ASCII message number and, if desired, the text of any system message appearing on the display.

```
"OUTPERRO;"
```

Where to Find Other Query Commands

Refer to the chapter on programming codes in the *8510C Network Analyzer System Keyword Dictionary*. You'll find useful information in the "8510C Query Commands" table near the end of that chapter.

Local Operation

Return the network analyzer to local control by pressing the front panel **LOCAL** key or by issuing the GPIB command `GTL 716` or `GTL 7` (`LOCAL 716` or `LOCAL 7` using HP Series 200/300 BASIC language).

Program Debugging Aids

To further assist in program development, the statements `DEBUON`; (debug on) and `DEBUOFF`; (debug off) control a network analyzer debug mode. Instructions currently being executed are displayed in the title area of the network analyzer.

Programming Examples

A sample program is supplied with your network analyzer, on the *8510C Software Toolkit Disk*. The name of the program is: **EX_8510**

The program contains many example routines, which show how to perform various programming tasks. The text on the following pages describe each of these examples.

The program requires BASIC 5.0 or higher with the following binaries: IO, MAT, TRANS, and COMPLEX.

The disk also contains a measurement data file (BPF_DATA) that is accessed by some of the programming example routines.

Example 1: Syntax Familiarization

This example can help you become familiar with the network analyzer GPIB instructions. The first part of this example sends commands (entered by the user) to the network analyzer. The second part sends query or output commands to the network analyzer and prints the response. You do not need to use quotation marks or include the final ';' when you enter GPIB commands. Syntax errors are detected and cleared. See Example 1, in "Example Program Listings" in this chapter, for the program executable using BASIC.

```
! Start: !
INPUT "Type 8510 command."; String$
OUTPUT @Nwa; String$
GOTO Start
```

The input statement displays a message, then waits for an input (type the string and then press computer Return or ENTER). Using a simple program like this one, you can input commands one at a time and observe the network analyzer response. At first, try instructions such as:

```
"STAR 10 GHz"
```

Refer to the list of programming codes in the *8510C Network Analyzer System Keyword Dictionary* to see the syntax requirements for each programmable function.

Enter a sequence of 8510C instructions by separating each instruction with a semicolon (;), as follows:

```
"STAR 2 GHz; STOP 10 GHz; CHAN2; LINP"
```

The network analyzer instruction **DEBUON** causes all network analyzer instructions to be displayed in the title area of the network analyzer display. The last 30 characters in the instruction queue appear, with the most recently received instruction at the left-hand side of the title area, pushing instructions higher on the queue off to the right. This means that the currently executing command may not be visible if the queue is over 30 characters long. Use the network analyzer instruction **DEBUOFF** to disable display of the command queue.

If the network analyzer does not recognize a mnemonic, or cannot execute it in the correct sequence, then GPIB activity stops and the instruction in error is shown in the title area of the network analyzer display with an upward pointing arrow at the location of the error. You must press **(LOCAL)**, then continue operation, or issue an GPIB DCL or SDC (the example program does this for you).

Commands are executed in the sequence in which they are received by the network analyzer. When a command is received, the syntax is checked, stored in the command queue, then executed. Some commands, such as **SING**, free the processor for other tasks during the time that they are executing. If time becomes available while such a command is executing, the process of reading a command, syntax checking, storage in the command queue, and sometimes overlapping execution continues until up to eight commands are stored for pending execution.

The second part of this example sends instructions that prompt a response from the network analyzer. These are the query commands and the **OUTPxxxx;** commands. Refer the *8510C Network Analyzer System Keyword Dictionary* for more information.

```
OUTPUT 716;"STAR; OUTPACTI;"
ENTER 716; Freq
PRINT Freq
```

This example prints the current value for start frequency.

Example 2: Active Function Output

The following example executes a user preset, then reads and prints the current values for seven active functions. The value for any function that can be made the active function can be read this way. Functions or settings that do not have an active function may be read using query commands. (Refer to the *8510C Network Analyzer System Keyword Dictionary* for a list query commands.)

The value of the current active function is output as a single ASCII value in the basic units of the function. For example:

```
OUTPUT @Nwa;"MARK1;OUTPACTI;"
ENTER @Nwa;Freq
```

When executed with a marker as the active function, the sequence (above) returns the frequency (in Hertz) at the marker position.

The sequence **AVERON; OUTPACTI;** outputs the currently selected averaging factor. The sequence **ELED; OUTPACTI;** returns the currently selected Electrical Delay value in seconds.

The title and various other user-defined labels can also be read over the GPIB by making it the active function, then reading the characters into a string variable. For example:

```
OUTPUT @Nwa;"TITL; OUTPTITL;"
ENTER @Nwa; String$
```

This example returns the current title as the active function. The title, calibration kit label, standard class label, standard label, and the user parameter label are enclosed in quotation marks. The standard class assignments list does not include the quotation marks.

Programming Examples

Example 3: Marker Output

This example prints the x- and y-axis values of a marker in any selected domain or format. A single sweep with averaging (factor of 4) is taken before reading the marker. Then, the display format is queried and appropriate units are printed for the y axis value. Next, the x axis value is read and the selected domain is queried and appropriate units are printed for the x axis.

If the system is currently operating in either the hold or the continual mode (see STIMULUS menu), then the data is output immediately; if SINGLE, or NUMBER OF GROUPS has been selected, then the data output operation waits until the specified number of sweeps has finished. For example, the following sequence selects the linear magnitude polar display, turns on averaging, and commands 17 groups of sweeps. When finished, marker 1 is turned on, moved to the maximum trace value, then the marker value is assigned to the variables Mag and Phase:

```
OUTPUT @Nwa;"LINP; AVERON 16;"
OUTPUT @Nwa;"NUMG 17; MARK1; MARKMAXI; OUTPMARK;"
ENTER @Nwa;Mag,Phase
```

The OUTPMARK; statement always transfers two values in standard ASCII format. As shown in Table 13-1, the values depend upon the currently selected display format. Two values are output in every display format, but for Cartesian displays the second value is zero.

Table 13-1. Marker Units for All display Formats

FORMAT	MARKER Basic Units	OUTPMARK A,B Value
LOG MAG	dB	dB, 0
PHASE	degrees (°)	degrees, 0
DELAY	seconds (s)	seconds, 0
SWR	(unitless)	SWR, 0
SMITH CHART	$R \pm jX (\Omega)$	ohms, ohms
LINEAR MAGNITUDE	ρ (unitless) (reflection) τ (unitless) (transmission)	lin mag, 0 lin mag, 0
LIN mkr on POLAR	$\rho \angle \varphi$ (reflection) $\tau \angle \theta$ (transmission)	lin mag, degrees lin mag, degrees
LOG mkr on POLAR	dB $\angle \varphi$	log mag, degrees
Re/lm mkr on POLAR	$x \pm jy$ (unitless)	real, imag
INVERTED SMITH	$g \pm jB$	Siemens, Siemens
REAL	x (unitless)	real, 0
IMAGINARY	jy (unitless)	real, 0

Data taken in step sweep mode requires only one group of sweeps (NUMG 1; or SING;) because each data point is averaged before the next point is measured.

To move the marker to a specific stimulus value, include a numeric value in the instruction. The following sequence moves marker 1 to the data point closest to 9.123456789 GHz, then transfers the marker value:

```
OUTPUT @Nwa;"MARK1 9.123456789 GHz; OUTPMARK;"
ENTER @Nwa;Mag,Phase
```

Example 4: Marker Operations

Use of the =Marker ("EQUA;") function is demonstrated for reference value, stimulus settings, and offset values. This may be very useful when combined with marker searches. Use of the =MARKER (EQUA;) function to position the trace on the display is shown in the following example.

```
OUTPUT @Nwa;"CHAN2; LOGM; MARK1; MARKMAXI; REFV; EQUA;"
```

This sequence selects channel 2, selects the LOG MAG display, moves the marker to the maximum point on the trace, then assigns the current marker value to the REF VALUE.

In all EQUA; applications, the current marker value becomes the value of the current active function. Valid functions for use with EQUA; are start, stop, center, span, reference value, electrical delay, phase offset, and the cutoff frequency for waveguide delay.

Next, this example finds the peak-to-peak range of a trace and measures the -3 dB bandwidth of a filter. The filter data is loaded from the file BPF_DATA (included on the software toolkit disk).

The marker functions are programmed in the same order as you would press the keys on the front panel. For example:

```
OUTPUT @Nwa;"MARK2; MARKMAXI; DELR2; MARK1; MARKMINI; OUTPMARK;"
ENTER @Nwa;Mag,Phase
OUTPUT @Nwa;"OUTPACTI"
ENTER @Nwa;Freq
OUTPUT @Nwa;"DELO; MARKOFF"
```

This sequence moves marker 2 to the maximum trace value, selects the delta marker mode with marker 2 as the reference marker, moves marker 1 to the maximum trace value, then outputs the difference between marker 2 and marker 1. Then the delta mode is turned off, and the markers are turned off.

To read marker values in dual-channel display modes, first select the channel, as follows:

```
OUTPUT @Nwa;"MARK1 3.5 GHz;"
OUTPUT @Nwa;"CHAN1; SING; AUTO; OUTPMARK;"
ENTER @Nwa;Mag,Phase
OUTPUT @Nwa;"CHAN2; SING; AUTO; OUTPMARK;"
ENTER @Nwa;Mag,Phase
```

The SING instruction (take single group of sweeps) or the NUMG instruction following channel selection, parameter change, or domain change, ensures that the trace has been updated and the data is ready to be read. After SING or NUMG, the network analyzer is placed in the hold mode. It is generally best to select the hold mode for data output. Use the CONT (CONTINUAL) instruction to restart the sweep.

When you change the parameter selection, you must take at least one group of sweeps to assure current data.

Note that if the system is in hold mode, the parameter is changed, and raw data is not available, then the raw data array is initialized to the equivalent of measured data equal to 0.0 at every data point. If LOG MAG is selected, the marker magnitude value is approximately -857 dB. The raw data array and trace are updated at the completion of the next group of sweeps.

Programming Examples

Example 5: Single- and Dual-Channel Displays

Network analyzer display modes (single-channel, dual-channel and four-parameter) are demonstrated in split and overlay display formats. Also, marker list functions 1 marker/ and 5 markers are shown with a four-parameter display.

Example 6: Trace Data Output/Input

In this example, the network analyzer measures a single sweep, then outputs a 201 point Corrected Data array using FORM 3. After this, the array of real and imaginary pairs is written back to the network analyzer. Before writing the data, the network analyzer is put in hold mode (this prevents the network analyzer from acquiring new data and overwriting the data being written by the program). The current data is first zeroed (by resetting the number of points while in hold mode). This forces the data array to be reallocated and be initially loaded with zeros (-857 dB); then the data is written.

Example 7: FORM1 Data Conversion

After taking a single sweep, the network analyzer outputs the current data array using FORM1 output format. This is the fastest form for data transfer. The FORM1 data is then converted to real/imaginary pairs, which are then converted to linear magnitude, log magnitude and phase data.

Example 8: S11 1-Port and S21 Response Cals

This set of examples guides you through an S11 1-port calibration and an S21 response calibration. Next, you measure a device using the S11 cal on channel 1 and the S21 cal on channel 2, in dual-channel display mode.

Example 8a reads the S21 response cal coefficient, processes the data, and writes it back into another cal set register. Then the S11 1-port cal coefficients for directivity, source match, and reflection tracking are read and displayed on the 8510C display.

Example 8b creates several frequency subset calibrations of the S11 1-port cal and saves them in other cal set registers.

As shown in the program listing, the measurement calibration sequence is performed under program control using the same procedure as described for the manual operation in the chapter on measurement calibration:

1. Select the calibration kit using CAL1 or CAL2.
2. Select the type of calibration to be performed.
3. Select the class of standard to be measured.
4. Measure the standards required for the class.
5. When all necessary standards in all necessary standard classes are measured, save the cal set and turn correction ON.

Selecting the Calibration Type

Use one of these mnemonics to select the calibration type:

Mnemonic	Cal Type
CALIRESP;	Response
CALIRAI;	Response and isolation
CALIS111;	S11 1-port
CALIS221;	S22 2-port
CALIFUL2;	Full 2-port
CALIONE2;	One-path 2-port
CALITRL2;	TRL 2-port
CALRCVR;	Receiver

Except for the TRL 2-port calibration, these are defined so there is one standard class for each error coefficient of the error model. All calibration types (except response) consist of multiple standard classes. In the 2-port calibrations, these classes are grouped into categories such as reflection, transmission, and isolation. The associated mnemonics (REFL;, TRANS;, and ISOL;) are used to proceed between the calibration type selection and the class selection.

Select the Standard Class

Because standard class labels are user-definable, a special mnemonic is used to select measurement of each standard class.

Mnemonic	Example Standard Class Labels
CLASS11A;	S11 OPEN (1st S11 standard class)
CLASS11B;	S11 SHORT (2nd S11 standard class)
CLASS11C;	S11 LOADS (3rd S11 standard class)
CLASS22A;	S22 OPEN (1st S22 standard class)
CLASS22B;	S22 SHORT (2nd S22 standard class)
CLASS22C;	S22 LOADS (3rd S22 standard class)
RAIRESP;	RESPONSE (response and isolation)
FWDT;	FWD. TRANS. THRU
FWDM;	FWD. MATCH THRU
REVT;	REV. TRANS. THRU
REVM;	REV. MATCH THRU
FWDI;	FWD. ISOL'N ISOL'N STD
REVI;	REV. ISOL'N ISOL'N STD
TRLT;	THRU THRU
TRLR1;	S11 REFLECT SHORT
TRLR2;	S22 REFLECT SHORT
TRLL;	LINE 2-18 SHORT

Programming Examples

If the single standard is assigned to the class, then any of these will cause a measurement restart and the measurement of the standard. The message `WAIT - MEASURING CAL STANDARD` appears while the measurement is being made. The speed of the measurement depends on the mode (ramp or step) selected and on the number of averages. For ramp sweep mode, $n+1$ sweeps (where n is the current averaging factor) are taken.

Select Calibration Standards in Class

If two or more standards are assigned to the class (up to seven may be assigned), then the standard to be measured is selected using the instructions `STANA` through `STANG`.

Again, since the standard labels are user-definable, a special mnemonic is used to select measurement of each standard in the class. This table shows the standard labels assigned to several of the standards in a typical cal kit, and the mnemonics used to select the standard:

Mnemonic	Examples of Standard Labels	
	(S11 and S22 LOADS)	RESPONSE
<code>STANA;</code>	BROADBAND	OPEN
<code>STANB;</code>	SLIDING	SHORT
<code>STANC;</code>	LOWBAND	THRU
<code>STAND;</code>	OFFSET	(not used)
<code>STANE;</code>	(not used)	(not used)
<code>STANF;</code>	(not used)	(not used)
<code>STANG;</code>	(not used)	(not used)

Any of these except `SLIDING` and `OFFSET` will cause a measurement restart and measurement of the standard. The message `WAIT - MEASURING CAL STANDARD` appears while the measurement is being made. The speed of the measurement depends on the mode (ramp or step) selected and on the number of averages.

If a sliding-type standard is used, then the instructions `LOAO;` (load offset) and `LOAN;` (load no offset) are used to measure the device.

Send the command `DONE;` when the necessary standards in the class are measured. The message `CAUTION ADDITIONAL STANDARDS NEEDED` is displayed if the standards already measured do not cover the current frequency range.

Save the Cal Set

The `DONE` or `SAVn` instruction (depending on calibration type) initiates final error coefficient computation. Finally, issue `CALSn` to specify the cal set to receive the error coefficients. Correction is turned ON for the parameters covered by the calibration set (for both channels if “coupled channels” is selected, or for the current channel if “uncoupled channels” is selected).

Example 9: Modify Cal Kit

This example demonstrates the ability to load a user-defined cal kit. After saving the original cal kit definition for cal kit 2 to disk, the program loads and labels a new definition typical for X-band waveguide cal kits. The new definition is also stored to disk before restoring the user's original cal kit.

Example 10: Simulated Standard Measurement

The 8510C can input raw calibration standard data from a controller and perform a calibration using this data rather than actual measured data. This example performs an S11 1-port cal using this technique. First data is collected for the standards that will be input in the actual SIMS calibration portion of the example. Then the simulated cal is performed and saved. For more information, refer to the listing for SIMS in the *8510C Network Analyzer System Keyword Dictionary*.

Example 11: Using the Drive Disk

The first part of this example stores (to disk) then loads (from disk) the instrument state, formatted and raw data arrays, display memory, and cal kit files. The file transfer can be done using the network analyzer's internal drive, or a compatible external drive connected to the network analyzer's system bus. The program prompts the user to choose which drive to use (internal or external).

In the second part of the example program, the computer reads and displays the disk files (which were stored in part 1 of the program). This is done to show the CITIfile format. A disk drive must be connected *to the computer* during this part of the example program.

The network analyzer disk drive is very useful during large tests because it provides capacity to store instrument states, cal sets, calibration kits, trace data, and other types of data. Refer to the Disk menu in Chapter 7 for a complete list of data types. The menu maps in the keyword dictionary show all disk functions and GPIB commands.

Using the Internal Disk

The following example shows how to store files using the built-in disk drive.

Store Instrument State 1 to a file named "IS_INST1"

```
OUTPUT @Nwa;"STOR; INSS1; DISF ""INST1"";"
```

Notice that you do not have to include the prefix (IS_). The network analyzer does this automatically.

Load the network analyzer memory from the disk as follows:

```
OUTPUT @Nwa;"HOLD;"
OUTPUT @Nwa;"CHAN1; LOAD; DATAFORM; DISF ""CHAN1"";"
OUTPUT @Nwa;"CHAN2; LOAD; DATAFORM; DISF ""CHAN2"";"
```

The example above loads the formatted data files "FD_CHAN1" and "FD_CHAN2".

If HOLD is not programmed, the formatted data traces are overwritten by new data during the next sweep.

Programming Examples

Note that in order to use `DATAFORM`, `DATARAW`, or `DATADATA`, the channel to which the data applies must be selected. When loaded, the trace is automatically updated. `DATARAW` stores information from the raw data array for the active parameter on the Active channel. However, there is an exception to this rule: If four parameter display is turned on, `DATARAW` stores *all four* raw data arrays for the selected channel.

To load a memory trace, the memory display must be off (`DISPDATA;`). Correction must be off (`CORROFF;`) before cal sets can be loaded into network analyzer memory from disk.

Note that the `DISF` command is used for all disk operations (store, load, replace, delete). The file name must be enclosed in quotation marks, and BASIC usually requires that in order to send the quote symbol that it be doubled.

File Name Prefixes

If you examine the directory following this operation, notice that the file name is given as `FD_FILE1`. The three character filename prefix is automatically included in the directory listing: it is the way in which the network analyzer operating system keeps track of the data type. This filename prefix is never used in the filename you select for store, load, or delete disk file operations. However, if the disk is to be read by the external computer directly, the prefix is considered part of the filename and must be used. Table 7-3 shows all file name prefixes used by the network analyzer.

Printing Your Own Messages on the Network Analyzer Display

Messages of up to 50 characters are displayed using:

```
"TITL" "GOOD MORNING" ";"
```

This causes the message `GOOD MORNING` to appear in the title area of the network analyzer display. The quotation marks are required; BASIC usually requires double marks to send quotation marks.

Text and graphics information can be written to the display using a special area of network analyzer memory, with an internal HP-GL subset or the standard plotting language implemented by the computer.

Example 12: Making Plots Using COPY

This example requires that a properly addressed XY plotter be connected to the network analyzer (system bus or RS-232 port). Refer to Chapter 6 for instructions. The program measures a single sweep with autoscaling, then plots each parameter.

Measurement results are output to a plotter connected to the network analyzer system bus using a sequence of commands to specify the quadrant on the paper, the pen number, and the data to be plotted. The following sequence plots the four parameters.

```
INPUT "Load Paper, then CONTINUE"  
OUTPUT @Nwa;"S11; SING; LEFU; PLOTALL"  
OUTPUT @Nwa;"S21; SING; LEFL; PLOTALL"  
OUTPUT @Nwa;"S12; SING; RIGU; PLOTALL"  
OUTPUT @Nwa;"S22; SING; RIGL; PLOTALL"
```

`PLOTALL` causes the entire screen, except the menu, to be plotted. Other commands to specify the part of the screen to be plotted and the pen color may be used.

Example 13: List Trace Values

This example requires a printer to be connected to the network analyzer (system bus or RS-232 port) and to be properly addressed. Refer to Chapter 6 for instructions. The program prints a tabular listing of the displayed trace. The data is printed in the displayed format (linear polar). A skip factor of 7 is used, so every seventh data point is printed.

The printer connected to the system bus may be used in the same way as in manual operation.

Example 14: Print to Printer on 8510C System Bus

This example requires a properly installed printer and plotter connected to the network analyzer's system bus. This example does not work with printers or plotters connected to the network analyzer's RS-232 ports. In this program example, the computer sends commands through the network analyzer to a printer and plotter connected to the network analyzer's system bus (pass through mode). The computer sends a title to the printer, and a label to the plotter.

General Input/Output

The network analyzer can pass computer commands through to devices on the system bus. In addition, the network analyzer can allow data to flow back from the device, direct to the computer.

Passing Commands through the Network Analyzer Devices on the System Bus

The network analyzer listens to commands sent to either of two addresses:

8510 Address The "8510 Address" (specified under **LOCAL ADDRESS of 8510**) is the address of the 8510C network analyzer itself. Any commands sent to this address will cause the 8510C to perform the function.

System Bus Address The "system bus" address (specified under **LOCAL SYSTEM BUS**) is the address of the system bus. Commands sent to this address will be passed to a specified device on the system bus.

How to send pass-through commands. First, you must tell the network analyzer which device you want to access directly. To do this, send the command:

```
ADDRPASS nn
```

where *nn* is the system bus address of the desired device.

Note *Why are some addresses three-digit numbers, while others are two-digit numbers?*

When you tell the computer to control an GPIB device, you must use a three-digit address. The first number (usually 7) selects the GPIB bus and is called the "GPIB bus select code." The last two digits are the address of a specific instrument on the bus. For example, when you program the computer to send the "PLOP" command to address 705, the following happens:

1. The "7" tells the computer to select the GPIB bus I/O card which is set to bus select code 7. (The GPIB bus uses a "bus select code" because there

Programming Examples

can be more than one GPIB bus in a computer system. The select code allows you to access multiple GPIB busses independently.)

2. The computer sends the command "PLOP", along with the two-digit instrument address number (05).
3. All instruments on the bus see the "PLOP" command. But only the device set to address 05 will accept the command and perform it.

(In this example, a plotter set to address 05 would perform the PLOP command, which plots a list of network analyzer operating parameter values.)

Devices on the network analyzer's system bus only use a two-digit address. A "bus select code" is not needed because the network analyzer is designed with only one system bus. When you enter the addresses of system bus devices (in the 8510C address menu), only two digits are required.

How pass-through works. Assume for now that the system bus address (under **LOCAL SYSTEM BUS**) is still set to 17. Also assume that you have selected a printer of the system bus with the ADDRPASS 01; command.

Under these conditions, the network analyzer will accept any command sent to address 717. When such a command is received, the analyzer passes it to the system bus, to the device at address 01.

For example:

```
OUTPUT @Nwa;"ADDRPASS 01;" ! Select address 01 for pass through commands
OUTPUT @Nwa_systbus; CHR"12" ! Send a form feed command to the printer
```

Remember, "@Nwa_systbus;" and "@Nwa_systbusdata" represent the address of the system bus. You must set this up using a statement such as:

```
"ASSIGN @Nwa_systbus TO 717"
```

If the device is to output ASCII data, use:

```
ENTER @Nwa_systbusdata; String$
```

where String\$ is dimensioned to accept the ASCII string sent from the device. If the device on the system bus does not terminate its output with the CR/LF, then the program must terminate the ENTER operation.

The specified pass-through address remains in effect until changed by the programmer. Instructions and data may be sent to the network analyzer GPIB address or to the network analyzer system bus address in any sequence. When the network analyzer system bus is addressed, an automatic system bus 'Local' is issued which halts all system bus activity and places the network analyzer in Hold. When the network analyzer GPIB is addressed following a pass-through, an automatic system bus 'Remote' is issued which returns control of the system bus to the network analyzer.

The addressed device cannot handshake to the computer or respond to GPIB universal or addressed commands via the system bus.

Pass-Through to a Printer

You may print directly to the printer using the pass-through mode as follows:

```
OUTPUT @Nwa;"ADDRPASS 01;" ! Printer's system bus address is 01
PRINTER IS 717 ! (@Nwa_systbus)
PRINT "MEASUREMENT NUMBER 1"
```

This example begins with the network analyzer instruction ADDRPASS 01 that sets the state in which data addressed to 717 (the 8510C system bus address) is passed through to the device at address 01 on the 8510C system bus. Next, a computer-specific command, HP 9000 Series 200/300 in this example, specifies the hardcopy device as the printer at address 717. Finally, the computer-specific hardcopy output statement outputs the message. The string is accepted at the network analyzer system bus address 717 and passed through to the printer.

Output to a Plotter

It is generally not recommended that HP-GL commands be passed through directly to the plotter on the network analyzer system bus; the typical drivers used for this purpose require communication with the computer during the operation, a capability not handled by network analyzer pass-through. You can, however, plot graphics and text to the network analyzer user display as described later in this section, then plot the network analyzer display to the plotter. Examples of printing or plotting using pass-through are given in the paragraphs describing user display graphics, below.

User Display Graphics**Example 15: Plot User Graphics**

User display functions are demonstrated by using HP-GL commands to draw a series of boxes. The boxes have labels that correspond to areas of the measurement display, which are used by various display formats. The user display is then:

- Stored to the internal disk.
- Erased.
- Reloaded from the disk.

Example 16: Plot Using BASIC HP-GL

This example draws a simple graphic on the network analyzer User display using BASIC graphics instructions. Optionally, the graphic may be sent to a plotter on the network analyzer system bus.

Vector diagrams and text can be written to a reserved area of the network analyzer display memory via the network analyzer system bus using either an HP-GL subset internal to the network analyzer, or the standard computer language graphics commands. This reserved graphics area is output using PLOTALL; and may be recorded and subsequently reloaded into user display memory using the Disk command USED;.

Vector Diagrams

A vector diagram consists of a PA (plot absolute) display instruction followed by any number of x,y integer pairs.

```
OUTPUT @Nwa;"ADDRPASS 31"
```

Programming Examples

```
OUTPUT @Nwa_systbus;"CS; PU"  
OUTPUT @Nwa_systbus;"PA 128,384; PD; PA 3328,384, 3328,3584, 128,3584, 128,384"
```

ADDRPASS 31 sets up the pass-through mode in which data sent to the 8510C system bus address, 717, is routed to the user display area of the network analyzer display memory. The CS instruction clears the screen. The PU instruction lifts the pen, causing the following PA instruction to draw a blank vector. The PD, Pen Down, causes the following PA instruction to draw a visible line. The PA, Plot Absolute, instruction is followed by the coordinates for the other three corners of the box.

The plotting area of the network analyzer display is:

$x = 0$ to 5377 , $y = 0$ to 4095

Figure 13-2 shows internal scaling for PA vector diagrams.

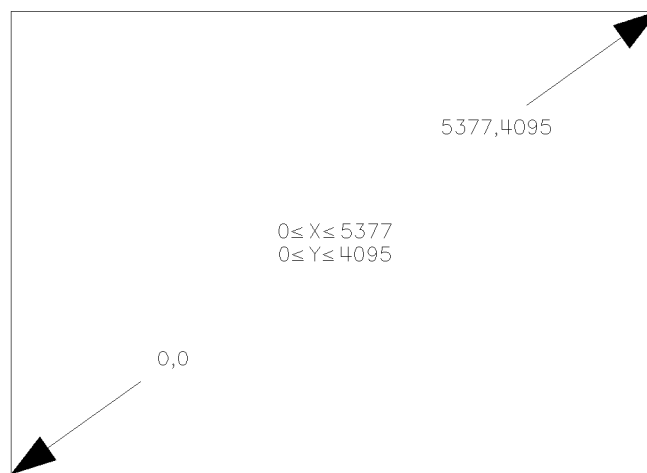

Figure 13-2. PA Vector Scaling

The PR, Plot Relative, instruction moves the pen from its present position to the new position x,y units away.

```
OUTPUT @Nwa;"ADDRPASS 31"  
OUTPUT @Nwa_systbus;"CS; PU"  
OUTPUT @Nwa_systbus;"PA 128,384; PD; PR 3200,0, 0,3200, -3200,0, 0,-3200"
```

This outlines the Menu labels area.

Text

Position standard ASCII text on the screen by addressing the text location with a PA or PR vector. Text between the LB mnemonic and the end of text character, CTRL C, is displayed beginning at the character cell position of the current vector. Figure 13-3 shows the 64 by 128 element character cell which encloses the 48 by 64 element character image area. The LB command is shown in the "PLOT TO PLOTTER ON 8510 SYSTEM BUS" example in the program examples section (at the end of this chapter).

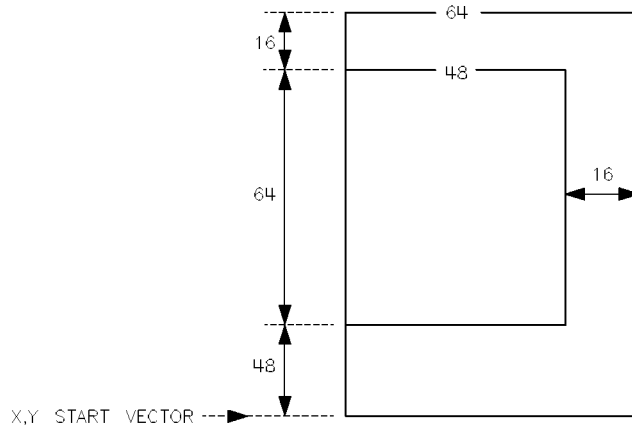

Figure 13-3. Text Character Cell

Select Pen Colors

The color selected for the current operation is specified using the `SPn;` command, where $n = 1$ to 16. The color is assigned to the pen in the same order as the colors appear in the set pen numbers menu under the define plot menu of the **COPY** hardkey.

Using the Internal Disk to Store the User Display

By storing the user display on the network analyzer disk drive, the vector diagrams and text can be recalled for display even if the computer is disconnected from the network analyzer. For example:

```
OUTPUT @Nwa;"STOR; USED; DISF ""USER1"";"
```

This stores the vector and text data presently in user display memory in user display file 1.

The user display graphics may be loaded from tape using:

```
OUTPUT @Nwa;"LOAD; USED; DISF ""USER1"";"
```

This erases the current user display, then loads and displays the previously stored graphics and text.

Summary of User Graphics Statements

The following statements are used to control plotting of vectors and text into the network analyzer user display area of internal memory.

- PA x_1, y_1 plot absolute vector. Move the pen from the current location to the location specified by the following x, y pair. Any number of x, y pairs may follow the PA instruction; each number must be separated from the previous number by a comma. $0 \leq x \leq 5377$; $0 \leq y \leq 4095$.
- PR x_1, y_1 plot relative vector. Move the pen from the current location to the relative position specified by the following x, y pair. Any number of x, y pairs may follow the PR instruction; each number must be separated from the previous number by a comma. $0 \leq x \leq 5377$; $0 \leq y \leq 4095$.
- PD Pen down. When followed by a PA or PR instruction, this instruction will cause a visible vector to be drawn to the new location.

Programming Examples

PU	Pen up. When followed by a PA or PR instruction, this instruction will cause a blank vector to be drawn to the new location.
LB	ASCII character label text. The ASCII characters following the LB command are drawn on the display beginning in the character cell at the current vector position. The string must be terminated with the end-of-text character, CNTRL C.
DF	Set to default state (PU, PA).
SPn	Select Pen (Color), 1 to 5 in the same sequence as shown in the set pen number menu (see COPY).

Summary of User Display Instructions

The following instructions control whether the standard measurement display (graticule, labels, etc.) and the user display are on or off.

KP	Turn off user display. Memory contents are not changed.
RP	Turn on user display. Memory contents are not changed.
PG	Clear (Erase) user display memory.
CS	Turn off measurement display (standard graticule, trace, and labels). User display is not affected.
RS	Turn on measurement display. User display is not changed.

Example 17: Redefine Parameter

This example redefines and displays the four user parameters. The new definitions are then saved in an instrument state register. It is possible to define both user and S-parameters specifying numerator, denominator, phase lock, and port drive.

Example 18: Read and Output Caution/Tell Message

This example prints the number and message of any error or warning shown on the network analyzer display. The user is first prompted to “Adjust” the network analyzer to force an error to be displayed. To get an error message, perform any of the following:

- Press the **Marker** key with no function active.
- Perform a disk directory (press **Disk** **DIRECTORY**) without a disk in the drive.
- Turn Calibration ON, but select an empty cal register.

Example 19: Read and Output Status Bytes

This program example displays the decimal value of the primary and extended status bytes. You are prompted to “Adjust” the network analyzer and then the status is read and displayed. Try pressing a front panel key or taking a single sweep.

The tables below show bit assignments of the network analyzer primary and secondary status bytes. These bits are set according to the current instrument state of the network analyzer system.

Important network analyzer instructions relating to the status word are:

- OUTPSTAT; Prepare the network analyzer to output the status word as two ASCII numbers, 0 to 255. Completion clears the status word to 0,0.
- CLES; Clear status bytes to 0,0; clear SRQ.
- SRQM a,b; Send two integer ASCII values, 0 to 255 to set the service request mask. Power On, TEST, and PRESET clear the service request mask to 0,0.

Read Status Bytes

Both status bytes are read using a sequence such as:

```
OUTPUT @Nwa;"OUTPSTAT;"
ENTER @Nwa; Primary,Secondary
```

where primary and secondary are variables to receive the value of each byte. You may read the status bytes in separate ENTER operations.

After the power up sequence is finished, bit 2 of the extended status byte is set, making the value of OUTPSTAT 0,4.

PRIMARY STATUS BYTE (#1)								
BIT #	7	6	5	4	3	2	1	0
Decimal Value	128	64	32	16	8	4	2	1
Function	Reason in extended byte	RQS (SRQ issued)	Syntax error	SING, NUMB, CALF, complete	Waiting for GET after reverse device	TRIG waiting for GET FASC; issued ready for external trigger	Data entry complete	CAUTION message displayed

EXTENDED STATUS BYTE (#2)								
BIT #	7	6	5	4	3	2	1	0
Decimal Value	128	64	32	16	8	4	2	1
Function	Not used	Not used	Not used	Not used	Not used	Power ON sequence finished	Key pressed	Not used

Setting the Service Request Mask

After power ON, TEST, and factory preset, the network analyzer SRQ mask is set to 0,0 and no changes in the primary or secondary status byte will generate an SRQ. To enable generation of an SRQ when one or more of the status bits changes from 0 to 1 (changes from cleared to set), specify the SRQ mask to sense the change in status. Using the network analyzer SRQM instruction, send two bytes, each having a value from 0 to 255, as follows:

```
OUTPUT @Nwa;"SRQM 16,0;"
```

Programming Examples

This will cause the network analyzer to generate an SRQ when bit 4 of the primary status byte changes from 0 to 1.

Detect and service the SRQ according to the computer protocol. Normal completion of a service cycle clears the network analyzer status bytes to 0,0 and does not change the SRQ mask.

Examples in the Example Program Listings show various interrupt service routines.

Example 20: Output Key Code

The key code (as documented in the *8510C Network Analyzer System Keyword Dictionary*) is printed for any network analyzer front panel key pressed by the user. The network analyzer is set to issue a SRQ when a key press occurs.

Example 21: Triggered Data Acquisition

External GPIB triggers are used to measure points in step sweep in this example. The 8510C is set to issue a service request when it is ready for a trigger.

Example 22: Wait Required

This example creates a continuously changing display pattern using an endless loop to update the values for electrical delay and parameter color. The main feature of this example is the "WAIT;" command that is sent to the network analyzer. This forces the display to update each time the loop is executed. Without the WAIT command, the loop might execute several times before the display updates and certain changes would be missed. Refer to the *8510C Network Analyzer System Keyword Dictionary* entry for WAIT.

Example 23: Wait Not Required

This example executes an endless loop which steps a marker to a new frequency and then reads the marker frequency, magnitude, and phase. The OUTPxxxx; commands used to read the marker value automatically hold off further program execution and ensure that the network analyzer has completed all prior instructions before the marker value is output. It is *not* necessary to send the network analyzer a WAIT; before reading the marker.

Example 24: Frequency List

This example shows how to define, manipulate, and read frequency list data. First, a three-segment frequency list is defined and activated. Next, the list and the trace data for S11 is output to the computer. Then, single segments (selected by the user) are swept, the network analyzer leaves, then re-enters, the frequency list mode.

Example 25: Output/Learn String

This example program performs a user preset, then prompts the user to change the current instrument state as desired. The learn string is then read out which includes the changes made by the user. Another user preset is done, then the learn string is loaded into the network analyzer. The network analyzer restores the modified instrument state.

The network analyzer learn string is a binary coded string which describes the current instrument state. This string may be read from the network analyzer to computer memory via the GPIB, then it may be loaded back into network analyzer memory in order to reset the system to the state represented by the string. This learn string is transferred using internal network analyzer binary format (FORM1), and it is not intended that the user attempt to decode or modify the string. Please note that each firmware revision may create learn strings of greater or smaller size (compared to learn strings created by other firmware revisions). Thus, learn strings created by one firmware version may not be compatible with earlier or later firmware revisions.

The following commands control transfer of the string.

OUTPLEAS; Output learn string to GPIB.

INPULEAS; Input learn string from GPIB; Set the network analyzer controls to that state.

The contents of the learn string is identical to the information processed by the SAVE and RECALL features for network analyzer internal storage, and the disk store and load instrument state functions for the network analyzer disk drive.

The following example shows a sequence to transfer the learn string. The learn string is 4390 bytes in length and can be read into an integer type array of length 2195.

```
DIM Integer Learn_string (4000)
OUTPUT @Nwa;"OUTPLEAS;"
ENTER @Nwa;Preamble, Size
REDIM Learn_string (1:Size/2)
ENTER @Nwa;Learn_string (*)
.
.
OUTPUT @Nwa;"INPULEAS;"
OUTPUT @Nwa_data;Preamble, Size, Learn_string (*)
```

OUTPLEAS; and INPULEAS; select FORM1 data format transfers. The data is transferred in a sequence beginning with the Preamble, #A; an integer size, that tells the number of bytes to follow, followed by the network analyzer internal binary format data which represents the control state of the network analyzer, with EOI asserted on the last byte.

Example 26: Input and Display ASCII Trace

This example writes trace data to the network analyzer in either floating point (FORM 3) or ASCII (FORM 4) formats. The data array is continuously re-written to the display with an offset added each time. Note the difference in speed between the two data formats.

Programming Examples

Example 27: Delay Table Operations

This example demonstrates how to input, output and apply table delay. The delay table is also stored and loaded using the network analyzer internal disk.

Example 28: Fast CW Data Acquisition

Fast CW setup and operation is demonstrated using an external trigger source. Once the data is collected, it is converted from FORM1 to real/imaginary data pairs.

Example 29: Test Port Power Flatness Cal

Test port power flatness cal can be performed only on a system using an 8360 Series source. If your system uses an 8350 or 8340 Series source, you must skip this example. A properly addressed power meter must also be connected to the 8510C network analyzer system bus.

After zeroing the power sensor, the user is prompted to connect it to port 1 on the test set. The calibration measures the power from 2 GHz to 20 GHz, compares the measured power to the source power setting, and calculates a power offset factor to obtain leveled power at the port. This correction array is stored in the source and applied to its output power when flatness is turned ON. When power flatness is ON, the value displayed or entered for source 1 power is the power at the test set port 1. With flatness OFF, it is the power at the source output.

Example 30: Receiver Power Cal/Power Domain

Note	Receiver calibration and power domain require 8510C firmware Rev. C.07.00 or greater.
-------------	---

This example performs a receiver calibration, which then allows the 8510C to display unratioed power measurements of the input and output power of a device connected between ports 1 and 2 on the test set, calibrated in dBm. A test port power flatness cal, valid from 2 GHz to 20 GHz, must have been performed before running this example. If you need to do a flatness calibration, run Example 29. When the calibration is finished, the display shows input power on channel 1 and output power on channel 2. The marker readout is calibrated in dBm.

Next, power domain is shown. The receiver cal performed in the frequency domain is converted automatically for use in power domain, as long as the frequency of the measurement is at a point in the original frequency domain cal. A valid frequency may be selected by placing a marker on the frequency point before entering power domain. The marker frequency is used as the frequency of measurement when power domain is selected. Once in power domain, the **NEXT PT HIGHER** and **NEXT PT LOWER** softkeys may be used to select a new frequency-of-measurement that is valid for the calibration.

Example 31: Disk Store and Load Using Cal Sets

This example performs storage and loading of data sets using the internal disk drive in the 8510C. Calibration set are used in this example, but other data types can be used by changing the intermediate commands in the sequence. The basic cal storage sequence is `STOR; , CALSn; , DISF; , filename. CALSn;` can be replaced with several other data type commands, such as: `INSSn`, `INSSALL`, `MEMOn`, `MEMALL`, `CALSALL`, `CALK1`, `CALK2`, `DATARAW`, `DATAFORM`, `DELT`, `USED`, `HARS`, `MACD`.

The `LOAD` version of the command is the same with `LOAD` replacing `STOR`. It can be switched between internal or external disk drive with `STOINT` or `STOIEXT`. External drives with multiple bays can be selected using `DISCVOL` and `DISCUNIT`. Refer to the menu structure for `DISC` in the front section of the *8510C Keyword Dictionary*.

General GPIB Programming

After the GPIB `REMOTE` command is issued, addressing the network analyzer using an appropriate `OUTPUT` statement causes the network analyzer to enter the remote mode in which the front panel hardkeys and softkeys are locked out. The only key that is not locked out is the `LOCAL` key. After the initial `OUTPUT` statement, either `ENTER` or `OUTPUT` statements are accepted.

Press the `LOCAL` key to restore front-panel control functions until the next `OUTPUT` command is received. Program the Local Lockout command, `LL0`, to lock out the front panel completely, even the `LOCAL` key. Issue the GPIB `LOCAL` command to cancel Local Lockout, then issue a `REN` command to return the network analyzer to remote command.

If the network analyzer is already addressed as a listener, a `GTL 716` (`LOCAL 716`) sets the network analyzer system to the normal manual mode without changing the current instrument state.

All GPIB Universal and Addressed Commands and the network analyzer system response to the commands are listed below. computer-specific and language considerations are discussed in the “Example Program Listings” later in this chapter.

Interface Functions

The following identification codes for the interface functions indicate the network analyzer GPIB interface capability.

SH1	Source handshake: full capability
AH1	Acceptor handshake: full capability
T6	Talker: basic talker, serial poll
TE0	No extended talker
L4	Listener: basic listener
LE0	No extended listener
SR1	Service request: full capability
RL1	Remote/local: complete capability
PP0	No parallel poll capability
DC1	Device clear: full capability
DT1	No device trigger capability
C0	No computer capability
E1	Driver electronic: tri-state drive

Response to GPIB Universal Commands

The network analyzer GPIB responds to the following universal commands from an external computer at any time, regardless of whether or not it is addressed. Refer to the language reference manual of the computer being used to find the corresponding commands allowed by the computer.

- DCL Device clear: Clears network analyzer status; no change in instrument state; system is ready to accept GPIB commands and data.
- LLO Local lockout: Disables the GPIB front panel **LOCAL** key. GTL to clear.
- SPD Serial poll disable: Disables the serial poll mode over the network analyzer GPIB.
- SPE Serial poll enable: Enables the serial poll mode over the network analyzer GPIB.
- PPU Parallel poll unconfigure: The network analyzer system does not respond.

Response to GPIB Addressed Commands

The network analyzer GPIB responds to the following addressed commands when it is addressed as a listener. Refer to the language reference manual of the computer being used to find the corresponding commands allowed by the computer.

- GET Group execute trigger: The network analyzer system, already in the triggered data acquisition mode, initiates the preprogrammed action of continuing the data acquisition process.
- GTL Go to local: Returns the network analyzer system to local control. Following GTL, the network analyzer GPIB will respond only to GPIB universal and addressed commands, not to GPIB data. Issue REN to enable data transfer using computer OUTPUT and ENTER commands.
- REN Remote enable: Enable all GPIB command and data functions.
- SDC Selected device clear: Clears network analyzer status, no change to instrument state; system is ready to accept instructions and data.

The network analyzer system does not respond to the following addressed commands.

- PPC Parallel poll configure.
- TCT Take control.

Example Program Listing

The following pages contain the program listing for the BASIC examples program. The program itself is supplied on the *Software Toolkit Disk* in LIF format for workstation BASIC (part number 85103-10002), supplied with the network analyzer. The name of the program is: EX_8510.

The program requires BASIC 5.0 or higher with the binaries IO, MAT, TRANS, and COMPLEX. The disk also contains a measurement data file (BPF_DATA) that is accessed by some of the programming example routines.

Programs in BASIC for Windows, C++, and Visual Basic can be found on the Agilent website: <http://www.agilent.com>. Enter 8510C Example Programs in the search window.

Example Programs in EX_8510

1. Syntax familiarization
2. Active function output
3. Marker output
4. Marker operations
5. Single- and dual-channel displays
6. Trace data output/input
7. FORM1 data conversion
8. S11 1-port and S21 response calcs
 - 8a. Cal error coefficients
 - 8b. Modify cal set frequency subset
9. Modify cal kit
10. Simulated standard measurement
11. Using disk and tape
12. Making Plots using COPY
13. List trace values
14. Print to printer on 8510C system bus
15. Plot user graphics
16. Plot using BASIC HP-GL
17. Redefine parameter
18. Read and output caution/tell message
19. Read and output status bytes
20. Output key code
21. Triggered data acquisition
22. WAIT required
23. WAIT not required
24. Frequency list
25. Output/learn string
26. Input and display ASCII trace
27. Delay table operations
28. Fast CW data acquisition
29. Test port power flatness cal
30. Receiver power cal
31. Disk store and load

Programming Examples

```

1      !      EXAMPLES FOR INTRODUCTION TO PROGRAMMING "EX_8510"
2      !      for revisions HP8510C.07.00: January 31, 1994 or later
3      !
4      !      Copyright @ HEWLETT-PACKARD COMPANY 1984,1994
5      !      SANTA ROSA SYSTEMS DIVISION
6      !      Copyright @ AGILENT TECHNOLOGIES COMPANY 2000
7      !      COMPONENT TEST PRODUCT GENERATION UNIT
8      !
9      ! You can view the SYNTAX of any of these examples.
10     ! Clear a line and type "EDIT ExampleXX" where X is the example number
11     !=====
12     OPTION BASE 0
13     DIM Formatted_data(200,1),Data(200,1)           ! 201 point trace I/O
14     DIM Data1(50,1),Data2(50,1),Data3(50,1)       ! 51 point trace I/O
15     INTEGER Form1_data(1:201,0:2)
16     INTEGER Learn_string(1:5000)
17     DIM Input$(200)
18     INTEGER Length,Error_number,Bytea,Byteb,Points,Trig,Segment
19     INTEGER Preamble,Size,Size_list,Mem
20     DIM Filename$(30),Current_line$(256),Response$(30)
21     REAL Freq,Freq2,Real,Imag,Mag,Phase,Log_mag,Lin_mag,Value
22     REAL Freq_list(400)
23     DIM Data_ascii$(200,1)[24]
24     ASSIGN @Nwa TO 716                          ! Network Analyzer HP-IB Address
25     ! Read ASCII Data to/from HP 8510 HP-IB (OUTPMARK, OUTPACTI, FORM4 I/O)
26     ASSIGN @Nwa_data1 TO 716;FORMAT ON          ! (OUTPERRO, OUTPSTAT, OUTPACTI)
27     ! Read non-ASCII Data to/from HP 8510 HP-IB (FORM1, FORM2, and FORM3 I/O)
28     ASSIGN @Nwa_data2 TO 716;FORMAT OFF
29     ASSIGN @Nwa_sysbus TO 717                    ! Write to 8510 System Bus
30     ASSIGN @Nwa_sysbusdata TO 717;FORMAT ON    ! Read from 8510 System Bus
31     !
32     ON TIMEOUT 7,1 GOTO No_analyzer
33     ABORT 7
34     CLEAR 716
35     PRINTER IS 1
36     CONTROL KBD,2;1                             ! Activate user softkeys
37     CLEAR SCREEN
38     OUTPUT @Nwa;"DEBUON; MKRLISTON; DATETIMEON; OUTPERRO;"
39     ENTER @Nwa_data1;Error_number                ! Clear Message
40     OFF TIMEOUT
41     !
42     PRINT
43     PRINT TAB(20);RPT$("*",37)
44     PRINT TAB(20);"*";TAB(56);"*"
45     PRINT TAB(20);"*  HP 8510C PROGRAMMING EXAMPLES  *"
46     PRINT TAB(20);"*";TAB(56);"*"
47     PRINT TAB(20);RPT$("*",37)
48     PRINT
49     PRINT "Note:   Refer to the GPIB Programming section of the 8510C Operating"
50     PRINT "       and Programming Manual for complete documentation."
51     PRINT
52     !
53     GOSUB Run_mode                               ! run All or a Single example
54     !
55     LINPUT "Example 1, Input Syntax Familiarization: Press Return",Input$
56     GOSUB Example1
57     !
58     LINPUT "Example 2, Active Function Output: Press Return",Input$
59     GOSUB Example2

```

Programming Examples

```
60                                     !
61  LINPUT "Example 3, Marker Output: Press Return",Input$
62  GOSUB Example3
63                                     !
64  LINPUT "Example 4, Marker Operations: Press Return",Input$
65  GOSUB Example4
66                                     !
67  LINPUT "Example 5, Single and Dual Channel Displays: Press Return",Input$
68  GOSUB Example5
69                                     !
70  LINPUT "Example 6, Trace Data Output / Input: Press Return",Input$
71  GOSUB Example6
72                                     !
73  LINPUT "Example 7, FORM1 Data Conversion: Press Return",Input$
74  GOSUB Example7
75                                     !
76  LINPUT "Example 8, S11 1-Port and S21 Response Cals: Press Return",Input$
77                                     ! Example8_a, Cal Error Coefficients
78                                     ! Example8_b, Modify Cal Set, Frequency Subset
79  GOSUB Example8
80                                     !
81  LINPUT "Example 9, Modify Cal Kit: Press Return",Input$
82  GOSUB Example9
83                                     !
84  LINPUT "Example 10, Simulated Standard Measurement: Press Return",Input$
85  GOSUB Example10
86                                     !
87  LINPUT "Example 11, Using Disc and Tape: Press Return",Input$
88  GOSUB Example11
89                                     !
90  LINPUT "Example 12, Plots Using Copy: Press Return",Input$
91  GOSUB Example12
92                                     !
93  LINPUT "Example 13, List Trace Values: Press Return",Input$
94  GOSUB Example13
95                                     !
96  LINPUT "Example 14, Print to Printer on 8510 System Bus: Press Return",Input$
97  GOSUB Example14
98                                     !
99  LINPUT "Example 15, Plot User Graphics: Press Return",Input$
100 GOSUB Example15
101                                     !
102 LINPUT "Example 16, Plot Using BASIC HPGL: Press Return",Input$
103 GOSUB Example16
104                                     !
105 LINPUT "Example 17, Redefine Parameter: Press Return",Input$
106 GOSUB Example17
107                                     !
108 LINPUT "Example 18, Read and Output Caution/Tell Message: Press Return",Input$
109 GOSUB Example18
110                                     !
111 LINPUT "Example 19, Read and Output Status Bytes: Press Return",Input$
112 GOSUB Example19
113                                     !
114 LINPUT "Example 20, Output Key Code: Press Return",Input$
115 GOSUB Example20
116                                     !
117 LINPUT "Example 21, Triggered Data Acquisition: Press Return",Input$
118 GOSUB Example21
```

Programming Examples

```

119      !
120  LINPUT "Example 22, WAIT Required: Press Return",Input$
121  GOSUB Example22
122      !
123  LINPUT "Example 23, WAIT Not Required: Press Return",Input$
124  GOSUB Example23
125      !
126  LINPUT "Example 24, Frequency List: Press Return",Input$
127  GOSUB Example24
128      !
129  LINPUT "Example 25, Output/Input Learn String: Press Return",Input$
130  GOSUB Example25
131      !
132  LINPUT "Example 26, Input and Display ASCII Trace: Press Return",Input$
133  GOSUB Example26
134      !
135  LINPUT "Example 27, Delay Table Operations: Press Return",Input$
136  GOSUB Example27
137      !
138  LINPUT "Example 28, FASTCW Data Acquisition: Press Return",Input$
139  GOSUB Example28140      !
141  LINPUT "Example 29, Test Port Power Flatness Cal: Press Return",Input$
142  GOSUB Example29
143      !
144  LINPUT "Example 30, Receiver Power Cal: Press Return",Input$
145  GOSUB Example30
146      !
147  LINPUT "Example 31, Cal Sets LOAD and STORE Operations: Press Return",Input$
148  GOSUB Example31
149      !
150  DISP "END OF EXAMPLES"
151  LOCAL @Nwa
152  STOP
153      !
154      ! *****
155      !
156 Example1:      ! INPUT SYNTAX FAMILIARIZATION *****
157  PRINT
158  PRINT "Example 1, Input Syntax Familiarization"
159      !
160  PRINT "  Commands"
161 Again1:      !
162  LOCAL @Nwa
163  LINPUT "TYPE 8510 INSTRUCTION, THEN RETURN; ENTER 0 TO EXIT",Input$
164  IF Input$[1,1]="0" THEN
165    PRINT "  Querys"
166    GOTO Query
167  END IF
168  OUTPUT @Nwa;Input$;" ;"
169  PRINT Input$,
170  IF BIT(SPOLL(@Nwa),5) THEN      ! Check for syntax error
171    GOSUB Syntax_error      ! Clear error
172  END IF
173  PRINT
174  GOTO Again1
175      !

```

Programming Examples

```
176 Query:                !
177 LOCAL @Nwa
178 LINPUT "TYPE 8510 QUERY OR OUTPUT INSTRUCTION, THEN RETURN; ENTER 0 TO EXIT ", Input$
179 IF Input$[1,1]="0" THEN
180     OUTPUT @Nwa;"OUTPERRO;"
181     ENTER @Nwa_data1;Error_number           ! Clear Message
182     RETURN
183 END IF
184 PRINT Input$,
185 OUTPUT @Nwa;Input$;";"
186 IF BIT(SPOLL(@Nwa),5) THEN                 ! Check for syntax error
187     GOSUB Syntax_error                     ! Clear error
188     PRINT
189 ELSE
190     ENTER @Nwa_data1;Input$
191     PRINT Input$
192 END IF
193 GOTO Query
194
195 Syntax_error:          !
196 PRINT "<< Syntax Error",
197 CLEAR @Nwa
198 OUTPUT @Nwa;"CLES; OUTPERRO;"
199 ENTER @Nwa;Error_number                 ! Clear Message
200 RETURN
201
202 Example2:              ! ACTIVE FUNCTION OUTPUT *****
203 PRINT
204 PRINT "Example 2, Active Function Output."
205
206 OUTPUT @Nwa;"USERPRES; LOGM;"
207
208 OUTPUT @Nwa;"STAR; OUTPACTI;"
209 ENTER @Nwa_data1;Value
210 PRINT " Start Frequency =";Value/1.E+6;" Mhz"
211
212 OUTPUT @Nwa;"STOP; OUTPACTI;"
213 ENTER @Nwa_data1;Value
214 PRINT " Stop Frequency =";Value/1.E+6;" Mhz"
215
216 OUTPUT @Nwa;"POWE; OUTPACTI;"
217 ENTER @Nwa_data1;Value
218 PRINT " Power Source 1 =";PROUND(Value,-2);" dbm"
219
220 OUTPUT @Nwa;"SCAL; OUTPACTI;"
221 ENTER @Nwa_data1;Value
222 PRINT "          Scale =";PROUND(Value,-2);" db/"
223
224 OUTPUT @Nwa;"REFV; OUTPACTI;"
225 ENTER @Nwa_data1;Value
226 PRINT " Refrence Value =";PROUND(Value,-2);" db"
227
228 OUTPUT @Nwa;"MAGO; OUTPACTI;"
229 ENTER @Nwa_data1;Value
230 PRINT "Magnitude Offset=";Value;" db"
231
232 OUTPUT @Nwa;"MAGS; OUTPACTI;"
233 ENTER @Nwa_data1;Value
234 PRINT "Magnitude Slope =";Value;" db/Ghz"
235 RETURN
```

Programming Examples

```

236          !
237 Example3: ! MARKER DATA OUTPUT *****
238          !
239 PRINT
240 PRINT "Example 3, Marker Data Output"
241 DISP "Initializing System"
242 OUTPUT @Nwa;"PRES;"
243 PRINT "Averaging On, Avg Factor = 4"
244 OUTPUT @Nwa;"AVERON 4; MENUFORM; POIN 51; SING;"
245 PRINT "Automatic Holdoff For Single or Number of Groups"
246          !
247 Again_3:  !
248 LOCAL @Nwa
249 LINPUT "Set 8510 to desired Domain, Format and Sweep Mode or E to Exit",Input$
250 IF UPC$(Input$)="E" THEN
251     OUTPUT @Nwa;"AVEROFF; FREQ; CONT;"
252     RETURN
253 END IF
254          !
255 OUTPUT @Nwa;"SWEM?"           ! Query sweep mode
256 ENTER @Nwa_data1;Input$
257 IF Input$[2;4]="RAMP" THEN
258     OUTPUT @Nwa;"NUMG 5;"      ! NUMG = AVER factor + 1
259 ELSE
260     OUTPUT @Nwa;"SING;"       ! 8510C automatically waits until SING or NUMG
261                               ! completes before executing further instructions
262 END IF
263          !
264 OUTPUT @Nwa;"AUTO; MARK1; MARKMAXI; OUTPMARK;"
265 ENTER @Nwa_data1;Mag,Phase    ! Read Marker Value
266 OUTPUT @Nwa;"FORM?;"         ! Query Display Format
267 ENTER @Nwa_data1;Input$
268          !
269 PRINT " Marker ";Input$;" = ";Mag;
270 IF Phase<>0 THEN PRINT Phase;
271          !
272 OUTPUT @Nwa;"MARK1; OUTPACTI;"
273 ENTER @Nwa_data1;Freq
274 OUTPUT @Nwa;"DOMA?;"         ! Query Domain
275 ENTER @Nwa_data1;Input$
276 SELECT Input$[2;3]
277 CASE "FRE"
278     PRINT " @";Freq/1.E+6;" Mhz"
279 CASE "AUX"
280     PRINT " @ ";Freq;" Volts"
281 CASE ="TIM"
282     PRINT " @ ";Freq*1.E+9;" nano Seconds"
283 CASE "PUL"
284     PRINT " @ ";Freq*1.E+6;" micro Seconds"
285 CASE "POW"
286     PRINT " @ ";Freq;" dBm"
287 END SELECT
288 GOTO Again_3
289          !
290 Example4: ! MARKER OPERATIONS *****
291          !
292 PRINT
293 PRINT "Example 4, Marker Operations"

```

Programming Examples

```
294          !
295 PRINT "Using = Marker"
296          !
297 DISP "Initializing System"
298 OUTPUT @Nwa;"PRES; POIN51; SING; AUTO; CONT;"
299          !
300 OUTPUT @Nwa;"MARK1; MARKMAXI;"
301 PRINT "Reference Value = Marker"
302 LINPUT "Press Return for REF VALUE = MARKER",Input$
303 OUTPUT @Nwa;"REFV; EQUA;"
304          !
305 OUTPUT @Nwa;"MARK1 5Ghz;"
306 PRINT "Start Frequency = Marker"
307 LINPUT "Press Return for START FREQ = MARKER",Input$
308 OUTPUT @Nwa;"STAR; EQUA;"
309          !
310 OUTPUT @Nwa;"MARK2 15Ghz;"
311 PRINT "Stop Frequency = Marker"
312 LINPUT "Press Return for STOP FREQ = MARKER",Input$
313 OUTPUT @Nwa;"STOP; EQUA;"
314          !
315 PRINT "Phase Offset = Marker"
316 LINPUT "Press Return for PHASE OFFSET = MARKER",Input$
317 OUTPUT @Nwa;"PHAS; AUTD; MARK3 10.25E9;"
318 OUTPUT @Nwa;"PHAO; EQUA;"
319          !
320 PRINT "Peak-to-Peak Measurement."
321          !
322 LINPUT "Press Return for Peak-to-Peak Measurement",Input$
323 OUTPUT @Nwa;"LOGM; MARKOFF; ENTO; SING; AUTO; MKRLISTON;"
324 OUTPUT @Nwa;"MARK2; MARKMAXI; DELR2; MARK1; MARKMINI; OUTPMARK;"
325 ENTER @Nwa_data1;Mag,Phase
326 OUTPUT @Nwa;"OUTPACTI;"
327 ENTER @Nwa_data1;Freq
328 PRINT "P-P Mag = ";Mag;"      P-P Freq = ";Freq
329 OUTPUT @Nwa;"MKRLISTON;"
330 LINPUT "Press Return for -3db Measurement",Input$
331 OUTPUT @Nwa;"DELO; MARKOFF; CONT;"
332          !
333 PRINT "-3 dB Bandwidth Measurement."
334          !
335 OUTPUT @Nwa;"S21; POIN 201; SPAN 1GHZ; CENT 10.24GHZ; SING;"
336 ASSIGN @File TO "BPF_DATA"      ! load data for band pass filter
337 ENTER @File;Preamble,Size,Data(*)
338 ASSIGN @File TO *
339 OUTPUT @Nwa;"FORM3; INPURAW1;"
340 OUTPUT @Nwa_data2;Preamble,Size,Data(*)
341          !
342 OUTPUT @Nwa;"REFP 7; SCAL 3; MARKCONT; MARK1; MARKMAXI; REFV; EQUA;"
343 OUTPUT @Nwa;"MARK2; MARKMAXI; MARK3; MARKMAXI;"
344 OUTPUT @Nwa;"DELR1; TARV -3; MARKTARG; MARK2; SEAL;"
345 OUTPUT @Nwa;"DELR2; MARK3; OUTPACTI;"
346 ENTER @Nwa_data1;Freq
347 PRINT "-3db Bandwidth      = ";Freq/1.E+6;" MHz"
348          !
349 OUTPUT @Nwa;"DELO; MARK2; OUTPACTI;"
350 ENTER @Nwa_data1;Freq
351 OUTPUT @Nwa;"MARK3; OUTPACTI;"
352 ENTER @Nwa_data1;Freq2
```

Programming Examples

```

353 PRINT "Center Frequency = ";((Freq+Freq2)/2)/1.E+9;" GHz"
354 RETURN
355 !
356 Example5: ! DISPLAY MODES *****
357 PRINT
358 PRINT "Example 5, Display Modes"
359 !
360 ! SINGLE CHANNEL DISPLAYS
361 !
362 PRINT "Single Channel, Four Parameter Split Display"
363 OUTPUT @Nwa;"COUC; CHAN1; FOUPSPLI; NUMG2;"
364 OUTPUT @Nwa;"S11; AUTO; S21; AUTO; S12; AUTO; S22; AUTO;"
365 OUTPUT @Nwa;"S11; CONT; MKRLFIVM; MARK1; MARK2; MARK3; MARK4; MARK5;"
366 PRINT "Marker List shows All Markers for Selected Parameter"
367 !
368 LINPUT "Press Return to Continue.",Input$
369 OUTPUT @Nwa;"MKRLFOUP; MARK3;"
370 PRINT "Marker List shows Active Marker for all Parameters"
371 !
372 LINPUT "Press Return to Continue.",Input$
373 OUTPUT @Nwa;"FOUPOVER;"
374 PRINT "Single Channel, Four Parameter Overlay Display"
375 !
376 LINPUT "Press Return for Channel 2 Display",Input$
377 OUTPUT @Nwa;"CHAN2; SING; AUTO; CONT; MARK1;"
378 PRINT "Single Channel, Single Parameter Display"
379 PRINT "Single or Four Parameter Display is Not Coupled"
380 !
381 LINPUT "Press Return for Channel 1 Display",Input$
382 OUTPUT @Nwa;"CHAN1;"
383 !
384 ! DUAL CHANNEL DISPLAYS
385 !
386 LINPUT "Press Return for Dual Channel Split Display",Input$
387 OUTPUT @Nwa;"SPLI;"
388 PRINT "Dual Channel, Single Parameter/Channel Split Display"
389 !
390 LINPUT "Press Return for Dual Channel Overlay Display",Input$
391 OUTPUT @Nwa;"OVER;"
392 PRINT "Dual Channel, Single Parameter/Channel Overlay Display"
393 !
394 LINPUT "Press Return to Continue",Input$
395 !
396 ! DUAL CHANNEL ALTERNATE SWEEP
397 !
398 PRINT "Dual Channel, Uncoupled Stimulus, Alternate Sweep"
399 OUTPUT @Nwa;"CONT; MARKOFF;"
400 OUTPUT @Nwa;"CHAN1; STAR 2 GHz; STOP 5 GHz; SING; CONT; UNCC;"
401 OUTPUT @Nwa;"CHAN2; S11; STAR 3 GHz; STOP 4 GHz;"
402 OUTPUT @Nwa;"SPLI; SING; CONT; MARK1 3.5 GHz; AUTO;"
403 !
404 LINPUT "Press Return to Continue",Input$
405 RETURN
406 !
407 Example6: ! TRACE DATA OUTPUT / INPUT *****
408 PRINT
409 PRINT "Example 6, Trace Data Output / Input (FORM3)."
```

Programming Examples

```

410          !
411          ! Output data from analyzer
412          !
413  OUTPUT @Nwa;"PRES;"
414  OUTPUT @Nwa;"POIN201; SPAN .5GHZ; REIP; SING; AUTO; FORM3; OUTPDATA;"
415  ENTER @Nwa_data2;Preamble,Size,Data(*)
416          !
417  PRINT "First and last data points of output corrected data array : "
418  PRINT "Point: 1";TAB(13);"Real:";Data(0,0);TAB(36);" Imag:";Data(0,1)
419  PRINT "Point: 201";TAB(13);"Real:";Data(200,0);TAB(36);" Imag:";Data(200,1)
420          !
421  OUTPUT @Nwa;"MARK1 0;"          ! set marker to first point
422  LOCAL @Nwa
423  INPUT "Corrected data array read. Press Return to Continue",Input$
424          !
425          ! Input data to analyzer
426          !
427  OUTPUT @Nwa;"ENT0; POIN201;"          ! Zero Trace for effect
428  LINPUT "Data Zeroed, Press Return To Write Data To 8510",Input$
429          !
430  OUTPUT @Nwa;"FORM3; IMPUDATA;"
431  OUTPUT @Nwa_data2;Preamble,Size,Data(*)
432  PRINT "Corrected array data Written (input) to 8510."
433  RETURN
434          !
435  Example7:          ! FORM1 DATA CONVERSION *****
436          !
437  PRINT
438  PRINT "Example 7, Form1 Data Conversion"
439  !
440  ! This example reads FORM1 data (internal binary format) and converts
441  ! it to real & imaginary, linear magnitude, log magnitude and phase.
442  ! The data arrays size will automatically adjust for any number of
443  ! measurement points. Converted values are printed for the first and
444  ! last points.
445  !
446  OUTPUT @Nwa;"SING; MARK1;"
447  OUTPUT @Nwa;"FORM1; OUTPDATA;"          ! or OUTPRAWn; OUTPDATA; OUTPFORM;
448          ! or OUTPDELA; OUTPMEMO;
449  ! note: if using OUTPFORM, Data_re(I) will be in the current display
450  ! format and Data_im(I) will = 0 for all display formats that
451  ! are not plots of real / imaginary pairs. Calculated linear,
452  ! log and phase values are not valid.
453  ENTER @Nwa_data2;Preamble,Size          ! Size/6 = number of data points
454          !
455  REDIM Form1_data(1:Size/6,2)          ! dimension 0 = imag mantissa,
456          ! 1 = real mantissa and 2 = common exponent
457          !
458  ENTER @Nwa_data2;Form1_data(*)          ! read the data
459          !
460  ! Calculate Exponent - The exponent is represented by bits 0-7 of
461  ! the 16 bit integer, Form1_data(n,2). Bit 7 is the sign bit (1="-",
462  ! 0="+"). The computed value is offset by -15 to give values which
463  ! are in a useful range for measurements. Thus, for Form1_data(n,2)
464  ! values of 0 to 127, exponents range from -15 to 112 and for values
465  ! of 128 to 255, exponents range from -143 to -16 respectively. This
466  ! gives a data range of ~ 674 to -860 db using db=20*LGT(2^(exponent)).
467  ! An alternate, table method is used to decode the exponent in example28.

```

Programming Examples

```

468 !
469 FOR I=1 TO SIZE(Form1_data,1)
470   Exponent=BINAND(Form1_data(I,2),255)      ! bits 0-7 are the exponent
471   !
472   IF Exponent<128 THEN                      ! exponent is positive
473     Exponent=2^(Exponent-15)                ! offset (-15)
474     !
475   ELSE                                       ! exponent is negative
476     Exponent=2^(BINCOMP(BINEOR(Exponent,255))-15) ! reverse [EOR],
477     ! change sign [CMP] and offset [-15] for negative going exponents
478   END IF
479   !
480   ! Calculate real and imaginary data
481   Real=Form1_data(I,1)*Exponent
482   Imag=Form1_data(I,0)*Exponent
483   !
484   ! Calculate linear magnitude data
485   Lin_mag=SQRT(Real^2+Imag^2)
486   !
487   ! Calculate log magnitude data
488   Log_mag=20*LGT(Lin_mag)
489   !
490   ! Calculate phase data
491   DEG
492   IF Imag=0 AND Real<0 THEN
493     Phase=-180
494   ELSE
495     Phase=2*ATN(Imag/(Real+Lin_mag))
496   END IF
497   !
498   IF I=1 OR I=SIZE(Form1_data,1) THEN      ! print first and last points
499     PRINT "Pt";I;"   Real = ";Real;"   Imag = ";Imag
500     PRINT "   Lin = ";Lin_mag;"   Log = ";Log_mag;"   Phase = ";Phase
501     PRINT
502   END IF
503 NEXT I
504 !
505 REDIM Form1_data(0:2,1:201)
506 !
507 PRINT
508 LOCAL @Nwa
509 RETURN
510 !
511 Example8:      ! S11 1-PORT AND S21 RESPONSE CALIBRATIONS *****
512 PRINT
513 PRINT "Example 8, S11 1-Port and S21 Response Calibrations"
514 !
515 OUTPUT @Nwa;"PRES; MENU CAL;"
516 LINPUT "Which Cal Kit is being used (ENTER 1 or 2)?",Kit$
517 PRINT "S11 1-Port Measurement Calibration USING Cal ";Kit$
518 OUTPUT @Nwa;"CLES; CAL";Kit$;" ; CALIS11;"
519 !
520 LINPUT "Port 1, Connect Shielded Open, then press Return",Input$
521 OUTPUT @Nwa;"CLASS11A;"
522 GOSUB Wait_for_meas
523 ! (Shielded Open Circuit Data Measured)
524 LINPUT "Port 1, Connect Short, then press Return",Input$

```

Programming Examples

```
525 OUTPUT @Nwa;"CLASS11B;"                ! (Short Circuit Data Measured)
526 GOSUB Wait_for_meas
527 OUTPUT @Nwa;"CLASS11C;"                ! (Uses Both LOWBAND and SLIDING)
528 LINPUT "Broadband OR Lowband, Sliding Load Cal (ENTER B or S)?",Input$
529 IF UPC$(Input$)="B" THEN
530     LINPUT "Port1, Connect Broadband Load, then press Return",Input$
531     OUTPUT @Nwa;"STANA;"
532     GOSUB Wait_for_meas
533 ELSE
534     LINPUT "Port 1, Connect Lowband Load, then press Return",Input$
535     OUTPUT @Nwa;"STANC;"                ! (LOWBAND Load Data Measured)
536     GOSUB Wait_for_meas
537     !
538     LINPUT "Port 1, Connect Sliding Load, then press Return",Input$
539     OUTPUT @Nwa;"STANB;"                ! (Select Sliding Load)
540     LINPUT "Move Element to First Index Mark, then press Return",Input$
541     OUTPUT @Nwa;"SLIS;"                ! (Sliding Load Data Measured)
542     GOSUB Wait_for_meas
543     FOR Slide=2 TO 6
544         LINPUT "Move Element to Next Index Mark, then press Return",Input$
545         OUTPUT @Nwa;"SLIS;"                ! (Sliding Load Data Measured)
546         GOSUB Wait_for_meas
547     NEXT Slide
548     OUTPUT @Nwa;"SLID;"
549 END IF
550     !
551 OUTPUT @Nwa;"DONE; SAV1; CALS4;"
552     ! (Error coefficients computed and stored;
553     ! Cal Menu displayed with CORRECTION ON;
554     ! Corrected S11 trace displayed.)
555 PRINT "S11 1-Port Cal Complete and Saved in Cal Set 4"
556 LINPUT "Press Return",Input$
557     !
558 PRINT "S21 Response Measurement Calibration."
559 OUTPUT @Nwa;"CHAN2; S21; CAL";Kit$;" CALIRESP;"
560 LINPUT "Connect Thru, then press Return",Input$
561 OUTPUT @Nwa;"STANC;"                ! (Thru Data Measured)
562 GOSUB Wait_for_meas
563 OUTPUT @Nwa;"DONE; CALS5;"
564     ! (Vector frequency response computed and stored;
565     ! Cal Menu displayed with CORRECTION ON;
566     ! Corrected S21 trace displayed.)
567 PRINT "Response Cal Complete and Saved in Cal Set 5"
568     !
569 LINPUT "Press Return",Input$
570     !
571 PRINT "Corrected Measurement Device S11 and S21."
572 LINPUT "Connect Device Under Test, then press Return",Input$
573 OUTPUT @Nwa;"SPLI; SING; AUTO; CHAN1; AUTO; CONT;"
574 LINPUT "Press Return",Input$
575     !
576 GOSUB Example8_a
577 GOSUB Example8_b
578     !
```

Programming Examples

```

579 Wait_for_meas:           ! Status Byte BIT 4 True when Standard Measured
580 REPEAT
581   Ser_poll=SPOLL(@Nwa)
582   WAIT .1
583   UNTIL BIT(Ser_poll,4)
584   OUTPUT @Nwa;"CLES;"
585   RETURN
586           !
587 Example8_a:               ! CAL ERROR COEFFICIENTS *****
588 PRINT
589 PRINT "Example 8_a, Calibration Error Coefficients"
590           !
591 OUTPUT @Nwa;"PRES;"
592 Read_response:           !
593 PRINT "Read Cal Coefficient, Cal 5 (S21 Response Cal)"
594 OUTPUT @Nwa;"S21; CORRON; CALS5; FORM3; OUTPCALCO1;"
595 ENTER @Nwa_data2;Preamble,Size,Data(*)
596           !
597 FOR N=0 TO 200
598           ! Data can be modified here
599   Formatted_data(N,0)=Data(N,0)
600   Formatted_data(N,1)=Data(N,1)
601 NEXT N
602           !
603 PRINT "Write Processed Cal Coefficients."
604 OUTPUT @Nwa;"CORROFF; CAL1; CALIRESP; FORM3; INPUCALCO1;"
605 OUTPUT @Nwa_data2;Preamble,Size,Formatted_data(*)
606 OUTPUT @Nwa;"SAVC; CALS6; CDNT;"
607           !
608 PRINT " Processed Cal saved in Cal Set 6."
609 LINPUT "Press Return",Input$
610           !
611 Read_1_port:             !
612           !
613 OUTPUT @Nwa;"DEBUOFF; HOLD; S11; CORRON; CALS4; OUTPERRO;"
614 ENTER @Nwa;Error_number           ! clear message
615           !
616 PRINT "Read and Display Cal Coefficients, Cal 4 (S11 1-Port)"
617 PRINT " Display Directivity Coefficient."
618 OUTPUT @Nwa;"FORM3; OUTPCALCO1;"
619 ENTER @Nwa_data2;Preamble,Size,Data(*)
620           !
621 OUTPUT @Nwa;"FORM3; INPUDATA;"
622 OUTPUT @Nwa_data2;Preamble,Size,Data(*)
623 OUTPUT @Nwa;"AUTO; TITL""PORT 1 DIRECTIVITY"";"
624 LINPUT "Press Return",Input$
625           !
626 PRINT " Display Source Match Coefficient."
627 OUTPUT @Nwa;"FORM3; OUTPCALCO2;"
628 ENTER @Nwa_data2;Preamble,Size,Data(*)
629           !
630 OUTPUT @Nwa;"FORM3; INPUDATA;"
631 OUTPUT @Nwa_data2;Preamble,Size,Data(*)
632 OUTPUT @Nwa;"AUTO; TITL""PORT 1 SOURCE MATCH"";"
633 LINPUT "Press Return",Input$
634           !
635 PRINT " Display Relection Tracking Coefficient."
636 OUTPUT @Nwa;"FORM3; OUTPCALCO3;"
637 ENTER @Nwa_data2;Preamble,Size,Data(*)

```

Programming Examples

```
638          !
639  OUTPUT @Nwa;"FORM3; INPUDATA;"
640  OUTPUT @Nwa_data2;Preamble,Size,Data(*)
641  OUTPUT @Nwa;"AUTO; TITL""PORT 1 REFLECTION TRACKING"";"
642          !
643  LINPUT "Press Return",Input$
644  OUTPUT @Nwa;"CONT; DEBUON;"
645  RETURN
646          !
647  Example8_b:      ! Modify Cal Set, Frequency Subset *****
648  PRINT
649  PRINT "Example 8_b, Modify Cal Set, Frequency Subset"
650          !
651  PRINT "Define Frequency Subset of Cal 4 (S11 1-Port)"
652  OUTPUT @Nwa;"CORRON; CALS4;"
653  OUTPUT @Nwa;"FRES; SUBSCENT 12 GHz; SUBSSPAN 2 GHz; CRES; CALS7;"
654          !
655  PRINT " Subset Defined, Cal Set 7."
656  LINPUT "Press Return",Input$
657  PRINT "Interactive Method to Define Frequency Subset."
658          !
659  OUTPUT @Nwa;"CORROFF; CORRON; CALS4; MENUCAL;"
660  OUTPUT @Nwa;"SOFT8; SOFT4; SOFT4;"          ! freq subset menu
661  LOCAL @Nwa
662  LINPUT "Define Frequency Subset, then Press Return.",Input$
663  OUTPUT @Nwa;"CRES; CALS8;"
664  PRINT " Subset Defined, Cal Set 8."
665  RETURN
666          !
667  Example9:      ! MODIFY CAL KIT (TYPICAL X-BAND WAVEGUIDE) *****
668  PRINT
669  PRINT "Example 9, Modify Cal Kit (Typical X-Band Waveguide)"
670          !
671  OUTPUT @Nwa;"USERPRES; MENUCAL;"
672  PRINT "Saving Current Cal Kit 2 to Disc."
673  LINPUT "Insert Initialized Disc, then Return",Input$
674  OUTPUT @Nwa;"STOIINT; STOR; CALK2; FILE2;"
675  PRINT "Old Cal Kit 2 now on File2."
676          !
677  PRINT "Defining New Cal Kit 2."
678  OUTPUT @Nwa;"MODI2; DEFS 1; STDTSHOR;"
679  OUTPUT @Nwa;"OFFD 0.018652 ns; OFFL 0; OFFZ 1;"
680  OUTPUT @Nwa;"MINF 6.557 GHz; MAXF 999 GHz;"
681  OUTPUT @Nwa;"WAVE; LABS""XSHORT 1""; STDD;"
682          !
683  OUTPUT @Nwa;"DEFS 2; STDTSHOR;"
684  OUTPUT @Nwa;"OFFD 0.055957 ns; OFFL 0; OFFZ 1;"
685  OUTPUT @Nwa;"MINF 6.557 GHz; MAXF 999 GHz;"
686  OUTPUT @Nwa;"WAVE; LABS""XSHORT 2""; STDD;"
687          !
688  OUTPUT @Nwa;"DEFS 3; STDTLOAD;"
689  OUTPUT @Nwa;"OFFD 0; OFFL 0; OFFZ 1; MINF 6.557 GHz; MAXF 999 GHz;"
690  OUTPUT @Nwa;"FIXE; WAVE; LABS""XLOAD""; STDD;"
691          !
692  OUTPUT @Nwa;"DEFS 11; STDTDELA;"
693  OUTPUT @Nwa;"OFFD 0; OFFL 0; OFFZ 1; MINF 6.557 GHz; MAXF 999 GHz;"
694  OUTPUT @Nwa;"WAVE; LABS""XTHRU""; STDD;"
```

Programming Examples

```

695      !
696  OUTPUT @Nwa;"SPECS11A 1; CLAD; SPECS11B 2; CLAD; SPECS11C 3; CLAD;"
697      !
698  OUTPUT @Nwa;"LABES11A""1/8 SHORT"";"
699  OUTPUT @Nwa;"LABES11B""3/8 SHORT"";"
700  OUTPUT @Nwa;"LABES11C""STDXLD"";"
701      !
702  OUTPUT @Nwa;"SPECS22A 1; CLAD; SPECS22B 2; CLAD; SPECS22C 3; CLAD;"
703      !
704  OUTPUT @Nwa;"LABES22A""1/8 SHORT"";"
705  OUTPUT @Nwa;"LABES22B""3/8 SHORT"";"
706  OUTPUT @Nwa;"LABES22C""STDXLD"";"
707      !
708  OUTPUT @Nwa;"SPECFWDT 11; CLAD; SPECREVT 11; CLAD;"
709  OUTPUT @Nwa;"SPECFWDM 11; CLAD; SPECREVM 11; CLAD;"
710  OUTPUT @Nwa;"SPECRESP 1, 2, 11; CLAD;"
711      !
712  OUTPUT @Nwa;"LABEFWDT"" THRU ""; LABEREVT"" THRU "";"
713  OUTPUT @Nwa;"LABEFWDM"" THRU ""; LABEREVM"" THRU "";"
714  OUTPUT @Nwa;"LABERESP""RESPONSE"";"
715      !
716  OUTPUT @Nwa;"LABK"" X BAND "";"
717  OUTPUT @Nwa;"KITD;"
718      !
719  OUTPUT @Nwa;"STOR; CALK2; FILE3; MENU CAL;"
720  PRINT "New Cal Kit now in File3."
721      !
722  LINPUT "Reload Old cal kit? (Y/N)",Input$
723  IF UPC$(Input$)="N" THEN RETURN
724  OUTPUT @Nwa;"LOAD; CALK2; FILE2; MENU CAL;"
725  PRINT "Prior Cal Kit 2 Reloaded."
726      !
727  RETURN
728      !
729  Example10:      ! SIMS CALIBRATION *****
730  PRINT
731  PRINT "Example 10, Simulated Calibration"
732      !
733  PRINT "Measure Standards Data Used For Simulated Cal."
734  OUTPUT @Nwa;"PRES; STEP; POIN51; AVERON 4; ENT0;"
735      !
736  LINPUT "Connect Short to Port 1, then Return",Input$
737  OUTPUT @Nwa;"SING; FORM3; OUTPDATA;"
738  ENTER @Nwa_data2;Preamble,Size,Data1(*)      ! std 1 data
739      !
740  LINPUT "Connect Open to Port 1, then Return",Input$
741  OUTPUT @Nwa;"SING; FORM3; OUTPRAW1;"
742  ENTER @Nwa_data2;Preamble,Size,Data2(*)      ! std 2 data
743      !
744  LINPUT "Connect Broadband Load to Port 1, then Return",Input$
745  OUTPUT @Nwa;"SING; FORM3; OUTPRAW1;"
746  ENTER @Nwa_data2;Preamble,Size,Data3(*)      ! std 3 data
747  OUTPUT @Nwa;"CONT;"
748      !
749      ! Begin SIMS S11 1-Port Calibration
750      !
751  OUTPUT @Nwa;"CLES; TRIG;"      ! Set Up FOR SIMS;
752  OUTPUT @Nwa;"CAL1; CALIS111"      ! Select Cal Type

```

Programming Examples

```

753 OUTPUT @Nwa;"CLASS11A;"           ! Select Standard (short)
754 GOSUB Wait_for_trig               ! Wait for Bit 2 then CLEAR 716
755 CLEAR @Nwa
756 OUTPUT @Nwa;"FORM3; INPRAW1;"     ! Input simulated Standard data
757 OUTPUT @Nwa_data2;Preamble,Size,Data1(*)
758 OUTPUT @Nwa;"SIMS;"               ! Input Complete
759 !
760 OUTPUT @Nwa;"CLASS11B;"           ! Select Next Standard (open)
761 GOSUB Wait_for_trig
762 CLEAR @Nwa
763 OUTPUT @Nwa;"FORM3; INPRAW1;"
764 OUTPUT @Nwa_data2;Preamble,Size,Data2(*)
765 OUTPUT @Nwa;"SIMS;"
766 !
767 OUTPUT @Nwa;"CLASS11C; STANA;"     ! Select Next Standard (broadband)
768 GOSUB Wait_for_trig
769 CLEAR @Nwa
770 OUTPUT @Nwa;"FORM3; INPRAW1;"
771 OUTPUT @Nwa_data2;Preamble,Size,Data3(*)
772 OUTPUT @Nwa;"SIMS;"
773 !
774 OUTPUT @Nwa;"DONE;"               ! Standard Class Complete
775 OUTPUT @Nwa;"SAV1; CALS3;"        ! Cal Complete and Saved
776 OUTPUT @Nwa;"FRER;"               ! Return to normal sweeping
777 !
778 PRINT "Simulated Cal Complete and Saved in Cal Set 3"
779 RETURN
780 !
781 Wait_for_trig:                    ! Bit 2, ready for trigger
782 REPEAT
783   Ser_poll=SPOLL(@Nwa)
784 UNTIL BIT(Ser_poll,2)
785 RETURN
786 !
787 Example11:                        ! USING DISC / READ CITIFILE *****
788 PRINT
789 PRINT "Example 11, Using Disc / Read CITIFile"
790 OUTPUT @Nwa;"PRES; POIN51; USER1; SING; DATI; S11; SPLI; SING;"
791 !
792 Disc:                              !
793 LINPUT "Internal or External Disc? (I or E).",Input$
794 IF UPC$(Input$)="E" THEN
795   OUTPUT @Nwa;"STOEXT;"            ! Use External Disc *****
796   LINPUT "Insert Disc in External Drive, then Return",Input$
797 ELSE
798   OUTPUT @Nwa;"STOINT;"            ! Use Internal Disc *****
799   LINPUT "Insert Disc in Internal Drive, then Return",Input$
800 END IF
801 OUTPUT @Nwa;"SAVE1;"               ! save set-up in instrument state 1
802 !
803 Initdisc:                          !
804 LINPUT "Initialize Disc? (ENTER Y or N)",Input$
805 IF UPC$(Input$)="Y" THEN OUTPUT @Nwa;"INID;"
806 !
807 Storedisc:                          !
808 PRINT "Store Data to Disc"
809 OUTPUT @Nwa;"STOR; INSS1; DISF ""IFILE1"";"
810 OUTPUT @Nwa;"CHAN1; STOR; DATARAW; DISF ""DFILE1"";"

```

Programming Examples

```

811 OUTPUT @Nwa;"CHAN2; STOR; DATARAW; DISF ""DFILE2"";"
812 OUTPUT @Nwa;"STOR; MEMO1; DISF ""MFILE1"";"
813 OUTPUT @Nwa;"STOR; CALK1; DISF ""KFILE1"";"
814 OUTPUT @Nwa;"DIRE;"
815 LOCAL @Nwa
816 LINPUT "Directory Displayed, Press Return to Load Data",Input$
817      !
818 Loaddisc:      !
819 PRINT "Load Data From Disc"
820 OUTPUT @Nwa;"LOAD; INSS1; DISF ""IFILE1"";"
821 OUTPUT @Nwa;"RECA1;"
822 PRINT "HOLD Avoids Overwriting Data Loaded From Disc."
823 LINPUT "Press Return",Input$
824 OUTPUT @Nwa;"CHAN1; LOAD; DATARAW; DISF ""DFILE1"";"
825 OUTPUT @Nwa;"CHAN2; LOAD; DATARAW; DISF ""DFILE2"";"
826 OUTPUT @Nwa;"CHAN2; DISPDATA; CHAN1; DISPDATA;"
827 PRINT "Must Turn Both Channel's Memories Off Before Loading any Memory."
828 OUTPUT @Nwa;"LOAD; MEMO1; DISF ""MFILE1"";"
829 OUTPUT @Nwa;"DISPDATM;"
830      !
831 LINPUT "Print Contents of a CITIfile? (ENTER Y or N) External Drive Required on Controller Bus",!
832 IF UPC$(Input$)<>"Y" THEN RETURN
833 OUTPUT @Nwa;"DIRE;"
834 LINPUT "Output to Printer or Controller CRT? (ENTER P or C)",Out$
835 IF UPC$(Out$)="P" THEN
836     LINPUT "Is Printer on 8510 System Bus? (ENTER Y or N)",Input$
837     IF UPC$(Input$)="Y" THEN
838         PRINTER IS 717
839         OUTPUT @Nwa;"ADDRPASS 01;"
840     ELSE
841         PRINTER IS 701      ! Connected to Controller HP-IB
842     END IF
843 ELSE
844     PRINTER IS 1      ! Print to Controller CRT
845 END IF
846      !
847 LINPUT "INSTALL DISC IN CONTROLLER DRIVE :,700,0 THEN RETURN.",Input$
848 Citiread:      !
849 LINPUT "NAME OF CITIfile to Read?",File_name$
850 ON ERROR GOSUB File_error
851 ASSIGN @Discfile TO UPC$(File_name$)&" :,700,0"
852 ON END @Discfile GOTO End_of_file
853 PRINT "DISC FILE NAME=",File_name$
854 PRINT
855 I=0
856 LOOP
857     I=I+1
858     ENTER @Discfile;Current_line$
859     PRINT Current_line$
860     IF I MOD 16=0 AND UPC$(Out$)="C" THEN INPUT "Press Return to Continue",In$
861 END LOOP
862 End_of_file:      !
863 PRINT
864 PRINT "END OF FILE"
865 PRINTER IS 1
866 LINPUT "Print Another CITIfile? (ENTER Y or N)",Input$
867 IF UPC$(Input$)="Y" THEN GOTO Citiread
868 OFF ERROR
869 OUTPUT @Nwa;"ENTO;"
870 RETURN

```

Programming Examples

```
871      !
872 File_error:      !
873 IF ERRN=56 OR ERRN=53 OR ERRN=58 THEN      ! file undefined or wrong type
874     IF ERRN=56 OR ERRN=53 THEN
875         PRINT "File ";File_name$;" Not Found.  Check Directory On 8510 Display"
876     ELSE
877         ! ERRN=58
878     PRINT "File TYPE Must Be ASC.  Check Directory On 8510 Display."
879     END IF
880     BEEP 300,.1
881     LINPUT "NAME OF CITIfile to Read?",File_name$
882     ELSE
883     OFF ERROR
884     END IF
885     RETURN
886 Example12:      ! PLOTS USING COPY *****
887     PRINT
888     PRINT "Example 12, Plots Using Copy"
889     PRINT "Requires Properly Addressed 8510C Plotter"
890     LINPUT "Skip This Example ? (ENTER Y or N)",Input$
891     IF UPC$(Input$)<>"N" THEN RETURN
892     !
893     OUTPUT @Nwa;"DEBUOFF; PRES; POIN51; MARK1; FOUPSPLI; ENTO; OUTPERRO;"
894     ENTER @Nwa;Error_number      ! clear message
895     LINPUT "Load Paper, then Return",Input$
896     PRINT "Press any 8510C key to ABORT Plot."
897     OUTPUT @Nwa;"SING; AUTO; S21; AUTO; S12; AUTO; S22; AUTO;"
898     OUTPUT @Nwa;"FULP; PLOTALL;"
899     !
900     INPUT "Wait until Plotter has finished Plotting, then Press Return",Input$
901     RETURN
902     !
903 Example13:      ! TRACE LIST TO PRINTER *****
904     PRINT
905     PRINT "Example 13, List Trace Values to System Printer."
906     !
907     PRINT "Requires Properly Addressed 8510C Printer"
908     LINPUT "Skip This Example ? (ENTER Y or N)",Input$
909     IF UPC$(Input$)="Y" THEN RETURN
910     !
911     PRINT "Printing 51 Point Trace, with Skip Factor of 7"
912     OUTPUT @Nwa;"SINC; S21; LINP; POIN51; SING; AUTO;"
913     OUTPUT @Nwa;"LISSKIP 7; LIST;"
914     RETURN
915     !
916 Example14:      ! PRINT TO PRINTER ON 8510 SYSTEM BUS ***
917     PRINT
918     PRINT "Example 14, Print / Plot To 8510C System Bus"
919     PRINT "Requires Printer and Plotter on HPIB System Bus"
920     LINPUT "Skip This Example ? (ENTER Y or N)",Input$
921     IF UPC$(Input$)<>"N" THEN RETURN
922     !
923     PRINT "Print Title via Pass-Thru."
924     OUTPUT @Nwa;"ADDRPASS 01;"
925     PRINTER IS 717      ! (Nwa_systbus)
926     PRINT
927     PRINT "MEASUREMENT NUMBER 1"
```

```

928 PRINT
929 OUTPUT @Nwa;"ENTO;"
930 PRINTER IS 1
931 LINPUT "Press Return",Input$
932 !
933 Example14a: ! PLOT TO PLOTTER ON 8510 SYSTEM BUS *****
934 !
935 PRINT "Plot Label via Pass-Thru."
936 OUTPUT @Nwa;"ADDRPASS 05;"
937 OUTPUT @Nwa_systbus;"CS;PU;SP1;PA 2500,2500;PD;LB PASS-THRU^C;PU;SPO;"
938 OUTPUT @Nwa;"ENTO;"
939 LINPUT "Press Return",Input$
940 RETURN
941 !
942 Example15: ! PLOT USER DISPLAY USING HP-GL SUBSET (8510C) *****
943 !
944 ! 8510C: X=0-5733 Y=0-4095
945 !
946 Plot_absolute: !
947 PRINT
948 PRINT "Example 15, User Display."
949 OUTPUT @Nwa;"ADDRPASS 31;"
950 OUTPUT @Nwa_systbus;"PG; CS; DF;" ! User display on and clear
951 !
952 OUTPUT @Nwa_systbus;"SP1; PA 0,0; PD;"
953 OUTPUT @Nwa_systbus;"PA 0,4095, 5733,4095, 5733,0, 0,0;"
954 OUTPUT @Nwa_systbus;"PU; PA 2475,3950; PD; LBFULL SCREEN^C;"
955 OUTPUT @Nwa_systbus;"PU;"
956 LINPUT "Press Return",Input$
957 !
958 OUTPUT @Nwa_systbus;"SP2; PA 180,384; PD;"
959 OUTPUT @Nwa_systbus;"PA 180,3585, 4660,3585, 4660,384, 180,384;"
960 OUTPUT @Nwa_systbus;"PU; PA 2420,1980; PD;" ! Polar Center
961 GOSUB Draw_cross
962 OUTPUT @Nwa_systbus;"PU; PA 2000,3300; PD; LBSINGLE CHANNEL^C;"
963 OUTPUT @Nwa_systbus;"PU;"
964 LINPUT "Press Return",Input$
965 !
966 OUTPUT @Nwa_systbus;"SP3; PA 180,1180; PD;"
967 OUTPUT @Nwa_systbus;"PA 180,2780, 2420,2780, 2420,1180, 180,1180;"
968 OUTPUT @Nwa_systbus;"PU; PA 1300,1980; PD;" ! Polar Center
969 GOSUB Draw_cross
970 OUTPUT @Nwa_systbus;"PU; PA 250,1500; PD; LBDUAL, CHANNEL 1^C;"
971 OUTPUT @Nwa_systbus;"PU;"
972 LINPUT "Press Return",Input$
973 !
974 OUTPUT @Nwa_systbus;"SP4; PA 2465,1180; PD;"
975 OUTPUT @Nwa_systbus;"PA 2465,2780, 4705,2780, 4705,1180, 2465,1180;"
976 OUTPUT @Nwa_systbus;"PU; PA 3585,1980; PD;" ! Polar Center
977 GOSUB Draw_cross
978 OUTPUT @Nwa_systbus;"PU; PA 2665,1500; PD; LBDUAL, CHANNEL 2^C;"
979 OUTPUT @Nwa_systbus;"PU;"
980 LINPUT "Press Return",Input$
981 !
982 OUTPUT @Nwa_systbus;"SP5; PA 180,210; PD;"
983 OUTPUT @Nwa_systbus;"PA 180,1760, 2335,1760, 2335,210, 180,210;"
984 OUTPUT @Nwa_systbus;"PU; PA 1255,980; PD;" ! Polar Center
985 GOSUB Draw_cross
986 OUTPUT @Nwa_systbus;"SP6; PU; PA 180,2260; PD;"

```

Programming Examples

```
987 OUTPUT @Hwa_systbus;"PA 180,3805, 2335,3805, 2335,2260, 180,2260;"
988 OUTPUT @Hwa_systbus;"PU; PA 1255,3030; PD;"          ! Polar Center
989 GOSUB Draw_cross
990 OUTPUT @Hwa_systbus;"SP7; PU; PA 2510,2260; PD;"
991 OUTPUT @Hwa_systbus;"PA 2510,3805, 4665,3805, 4665,2260, 2510,2260;"
992 OUTPUT @Hwa_systbus;"PU; PA 3590,3030; PD;"          ! Polar Center
993 GOSUB Draw_cross
994 OUTPUT @Hwa_systbus;"SP9; PU; PA 2510,210; PD;"
995 OUTPUT @Hwa_systbus;"PA 2510,1760, 4665,1760, 4665,210, 2510,210;"
996 OUTPUT @Hwa_systbus;"PU; PA 3590,980; PD;"          ! Polar Center
997 GOSUB Draw_cross
998 OUTPUT @Hwa_systbus;"SP5; PU; PA 250,500; PD; LBFOUR PARAMETER^C;"
999 OUTPUT @Hwa_systbus;"PU;"
1000 LINPUT "Press Return",Input$
1001      !
1002 OUTPUT @Hwa_systbus;"SP10; PA 4870,0; PD;"
1003 OUTPUT @Hwa_systbus;"PA 4870,4095, 5733,4095, 5733,0, 4870,0;"
1004 OUTPUT @Hwa_systbus;"PU; PA 4930,2000; PD; LBMENU AREA^C;"
1005 OUTPUT @Hwa_systbus;"PU;"
1006      !
1007 LINPUT "Press Return For Measurement Display On",Input$
1008      !
1009 OUTPUT @Hwa;"SINC; MENUDOMA; ENT0;"
1010 OUTPUT @Hwa_systbus;"RS;"          ! measurement display on
1011      !
1012 LINPUT "Insert Initialized Disc in 8510C Drive: Press Return",Input$
1013 PRINT "Store User Display to Disc."
1014 OUTPUT @Hwa;"STOIINT; STOR; USED; FILE1;"
1015      !
1016 LINPUT "Press Return For Measurement Display Off",Input$
1017 OUTPUT @Hwa_systbus;"CS;"          ! measurement display off
1018      !
1019 LINPUT "Erase User Display: Press Return",Input$
1020 OUTPUT @Hwa_systbus;"PG;"
1021      !
1022 LINPUT "Press Return For Measurement Display On",Input$
1023 OUTPUT @Hwa_systbus;"RS;"
1024      !
1025 LINPUT "Load User Display from Disc: Press Return",Input$
1026 PRINT "Load User Display from Disc."
1027 OUTPUT @Hwa;"STOIINT; LOAD; USED; FILE1;"
1028      !
1029 LINPUT "Next Example: Press Return",Input$
1030 OUTPUT @Hwa_systbus;"PG; RS;"
1031 RETURN
1032      !
1033 Draw_cross:          !
1034 OUTPUT @Hwa_systbus;"PR -200,0, 400,0, -200,0;"
1035 OUTPUT @Hwa_systbus;"PR 0,-200, 0,400, 0,-200;"
1036 RETURN
1037      !
1038 Example16:          ! PLOT TO USER DISPLAY USING BASIC HP-GL *****
1039 PRINT
1040 PRINT "Example 16, Plot Using BASIC HP-GL"
1041      !
1042 OUTPUT @Hwa;"SINC; FULP; ADDRPASS 31;"
1043 OUTPUT @Hwa_systbus;"PG; CS;"
```

Programming Examples

```
1044 PLOTTER IS 717,"HPGL"
1045 WINDOW 0,4095,0,4095
1046      !
1047      ! HP-GL PLOTTING STATEMENTS
1048      !
1049 FRAME
1050 MOVE 100,100
1051 DRAW 3995,3995
1052 MOVE 3995,100
1053 DRAW 100,3995
1054 MOVE 1600,800
1055 LABEL "BASIC HP-GL"
1056      !
1057 LINPUT "Output Display To 8510C Plotter ? (ENTER Y or N)",Input$
1058 IF UPC$(Input$)="Y" THEN
1059     OUTPUT @Nwa;"FULP; PLOTALL;"
1060 END IF
1061      !
1062 OUTPUT @Nwa_systbus;"PG; RS;"
1063 RETURN
1064      !
1065 Example17:      ! REDEFINE PARAMETER *****
1066 PRINT
1067 PRINT "Example 17, Redefine Parameter"
1068      !
1069 OUTPUT @Nwa;"PRES; POIN51; FOUPSPLI; DEBUOFF; ENTO;"
1070 OUTPUT @Nwa;"USER1; USER2; LOCKA2; DRIVPORT2; REDD;"
1071 OUTPUT @Nwa;"USER3; LOCKA2; DRIVPORT2; REDD; USER4;"
1072 OUTPUT @Nwa;"SAVE5;"
1073 PRINT "Redefined USER Parameters now Saved in INST STATE 5."
1074      !
1075      ! PRESET selects standard User parameter definition.
1076      ! RECALL 5 selects saved user parameter definitions.
1077      !
1078 RETURN
1079      !
1080 Example18:      ! READ AND OUTPUT CAUTION/TELL MESSAGE *****
1081 PRINT
1082 PRINT "Example 18, Read and Output Caution/Tell Message"
1083      !
1084 LOOP
1085     LOCAL @Nwa
1086     LINPUT "Adjust 8510C & Press Return to Read Caution/Tell (E to Exit)",Input$
1087     EXIT IF UPC$(Input$)="E"
1088     OUTPUT @Nwa;"OUTPERRO;"
1089     ENTER @Nwa_data1;Error_number,Input$
1090     PRINT Error_number,Input$
1091 END LOOP
1092 RETURN
1093      !
1094 Example19:      ! READ AND OUTPUT STATUS BYTES *****
1095 PRINT
1096 PRINT "Example 19, Read and Output Status Bytes"
```

Programming Examples

```
1097 LOOP
1098   OUTPUT @Nwa;"cles;"
1099   LOCAL @Nwa
1100   LINPUT "Adjust 8510C & Press Return to Read Status (E to Exit)",Input$
1101   EXIT IF UPC$(Input$)="E"
1102   OUTPUT @Nwa;"OUTPSTAT;"      ! output and clear status
1103   ENTER @Nwa_data1;Bytea,Byteb
1104   PRINT "Primary =" ;Bytea,"Extended =" ;Byteb
1105   END LOOP
1106   RETURN
1107   !
1108 Example20:  ! OUTPUT KEY CODE *****
1109   PRINT
1110   PRINT "Example 20, Output Key Code"
1111   !
1112   OUTPUT @Nwa;"DEBUON; CLES; SRQM 128,2;" ! set mask for key press
1113   ON INTR 7 GOSUB Key_code
1114   ENABLE INTR 7;2
1115   GOSUB Blank_keys
1116   ON KEY 5 LABEL " NEXT EXAMPLE" GOTO Exit_example20
1117   DISP "PRESS 8510 Front Panel Key. (f5 to EXIT.)"
1118   GOTO Wait_loop
1119   !
1120 Exit_example20:  !
1121   DISABLE INTR 7
1122   GOSUB Keys_off
1123   PRINT ""
1124   RETURN
1125   !
1126 Key_code:      !
1127   Ser_poll=SPOLL(@Nwa)
1128   OUTPUT @Nwa;"OUTPKEY;"
1129   ENTER @Nwa_data1;A
1130   PRINT A;
1131   ENABLE INTR 7
1132   RETURN
1133   !
1134 Example21:  ! TRIG Mode, TRIGGERED DATA ACQUISITION *****
1135   PRINT
1136   PRINT "Example 21, TRIG Mode, Triggered Data Acquisition"
1137   !
1138   DISP "Initializing System"
1139   OUTPUT @Nwa;"PRES;"
1140 Start_21:  !
1141   LINPUT "Press Return to start Triggered sweep.",Input$
1142   !
1143   OUTPUT @Nwa;"CLES; SRQM 4,0;"      ! ready for trigger bit
1144   OUTPUT @Nwa;"POIN; OUTPACTI;"
1145   ENTER @Nwa_data1;Points      ! number of points in sweep
1146   OUTPUT @Nwa;"ENTO;"
1147   ON INTR 7 GOTO Next_point
1148   ENABLE INTR 7;2
1149   Trig=0
1150   OUTPUT @Nwa;"STEP; TRIG;"      ! triggered step sweep mode
1151   GOTO Wait_loop
1152   !
1153 Next_point:  !
1154   Ser_poll=SPOLL(716)
```

Programming Examples

```

1155 IF Trig=Points THEN GOTO End_of_sweep
1156 TRIGGER 716      ! measure a point
1157 Trig=Trig+1
1158 DISP "Trigger =" ;Trig
1159 ENABLE INTR 7
1160 GOTO Wait_loop
1161      !
1162 End_of_sweep:  !
1163 OFF INTR 7
1164 PRINT "End Of Sweep," ;Trig;" points measured"
1165 LINPUT "Another Sweep? (ENTER Y or N)",Input$
1166 IF UPC$(Input$)="Y" THEN GOTO Start_21
1167 DISABLE INTR 7
1168 OUTPUT @Nwa;"FRER;"
1169 OUTPUT @Nwa;"CLES; SRQM 0,0"
1170 RETURN
1171      !
1172 Example22:      ! WAIT Required *****
1173 PRINT
1174 PRINT "Example 22, WAIT Required for display updates."
1175      !
1176 GOSUB Blank_keys
1177 ON KEY 5 LABEL " NEXT EXAMPLE" GOTO Exit_example22
1178      !
1179 OUTPUT @Nwa;"DEBUOFF; FOUPOVER; STEP; POIN101; SING;"
1180 OUTPUT @Nwa;"S11; LIMP; DATI; DISPMATH; PHAO 0;"
1181 OUTPUT @Nwa;"S21; LIMP; DATI; DISPMATH; PHAO 90;"
1182 OUTPUT @Nwa;"S12; LIMP; DATI; DISPMATH; PHAO 180;"
1183 OUTPUT @Nwa;"S22; LIMP; DATI; DISPMATH; PHAO 270;"
1184 OUTPUT @Nwa;"OUTPERRO;"
1185 ENTER @Nwa;Error_number      ! clear message
1186      !
1187 T=0                          ! initial tint increment value
1188 M=2.5E-11                    ! electrical delay increment
1189      !
1190 Eled:      !
1191 FOR N=0 TO 1 STEP M
1192   FOR P=1 TO 4
1193    SELECT P                    ! Choose Parameter
1194     CASE 1
1195      OUTPUT @Nwa;"S11; COLRS11D;"
1196      T1=T+0
1197     CASE 2
1198      OUTPUT @Nwa;"S21; COLRS21D;"
1199      T1=T+25
1200     CASE 3
1201      OUTPUT @Nwa;"S12; COLRS12D;"
1202      T1=T+50
1203     CASE 4
1204      OUTPUT @Nwa;"S22; COLRS22D;"
1205      T1=T+75
1206     END SELECT
1207     IF T1>100 THEN T1=T1-100
1208     OUTPUT @Nwa;"TINT";INT(T1);"      ! Change Color
1209     OUTPUT @Nwa;"ELED";P*N;"s;"      ! Increment Delay
1210     !
1211     OUTPUT @Nwa;"WAIT; ENT0;"      ! This WAIT insures that the 8510C updates
1212     ! the display before executing more commands
1213     !

```

Programming Examples

```
1214     T=T+.25 ! tint value increment
1215     IF T>100 THEN T=0
1216     NEXT P
1217 NEXT N
1218 GOTO Eled
1219     !
1220 Exit_example22: !
1221 OUTPUT @Nwa;"DEFC;" ! Default Colors
1222 GOSUB Keys_off
1223 RETURN
1224     !
1225 Example23: ! WAIT Not Required (holdoff included in OUTPxxxx) *****
1226 PRINT
1227 PRINT "Example 23, Wait Not Required (OUTPUxxxx holds off further execution)"
1228     !
1229 GOSUB Blank_keys
1230 ON KEY 5 LABEL " NEXT EXAMPLE" GOTO Exit_example23
1231     !
1232 OUTPUT @Nwa;"USERPRES; LOGM; SING; AUTO; STAR; OUTPACTI;"
1233 ENTER @Nwa;Freq1
1234 OUTPUT @Nwa;"STOP; OUTPACTI;"
1235 ENTER @Nwa;Freq2
1236     !
1237 OUTPUT @Nwa;"MARK1"
1238 LOOP
1239     FOR N=Freq1 TO Freq2 STEP (Freq2-Freq1)/50
1240         OUTPUT @Nwa;N;" " ! move marker to new frequency
1241         OUTPUT @Nwa;"OUTPACTI;"
1242         ENTER @Nwa;Freq ! read current marker frequency
1243         OUTPUT @Nwa;"OUTPMARK;"
1244         ENTER @Nwa;Mag,Phase
1245         DISP "Marker is ";Mag,Phase;" @ ";Freq;"Ghz"
1246     NEXT N
1247 END LOOP
1248     !
1249 Exit_example23: !
1250 GOSUB Keys_off
1251 OUTPUT @Nwa;"CONT;"
1252 RETURN
1253     !
1254 Example24: ! FREQUENCY LIST *****
1255 PRINT
1256 PRINT "Example 24, Frequency List"
1257     !
1258 OUTPUT @Nwa;"S21;"
1259 OUTPUT @Nwa;"EDITLIST; CLEL;"
1260 OUTPUT @Nwa;"SADD; STAR 2 GHz; STOP 4 GHz; STPSIZE 100 MHz; SDON;"
1261 OUTPUT @Nwa;"SADD; STAR 4 GHz; STOP 8 GHz; STPSIZE 200 MHz; SDON;"
1262 OUTPUT @Nwa;"SADD; STAR 8 GHz; STOP 16 GHz; STPSIZE 400 MHz; SDON;"
1263 OUTPUT @Nwa;"DUPD; EDITDONE;"
1264 OUTPUT @Nwa;"LISFREQ; SING; AUTO; CONT; SAVE7;"
1265     !
1266 PRINT "Frequency List set-up Complete and Saved in Instrument State 7."
1267 LINPUT "Press Return to Read Frequency List and Data.",Input$
1268     !
1269 OUTPUT @Nwa;"POIN; OUTPACTI;"
1270 ENTER @Nwa_data1;Points
1271 REDIM Freq_list(Points-1),Data(Points-1,1)
```

Programming Examples

```

1272  !
1273 PRINT "Read Frequency List and Data from 8510C."
1274 OUTPUT @Nwa;"FORM3; OUTPFREL;"
1275 ENTER @Nwa_data2;Preamble,Size_list,Freq_list(*)
1276 OUTPUT @Nwa;"FORM3; OUTPDATA;"
1277 ENTER @Nwa_data2;Preamble,Size,Data(*)
1278  !
1279 PRINT "Selected Unformatted Data from";Points;" Point Frequency List"
1280 FOR I=0 TO Points-1 STEP INT(Points/2)
1281   PRINT "Point";I+1;" is ";Data(I,0);Data(I,1);" @ ";Freq_list(I)
1282 NEXT I
1283  !
1284 LOOP
1285   INPUT "Enter Segment to Sweep (1-3) (0 to Exit).",Segment
1286 EXIT IF Segment=0
1287   OUTPUT @Nwa;"CONT; SSEG";Segment;"
1288   OUTPUT @Nwa;"SEG?;"
1289   ENTER @Nwa_data1;Input$
1290   OUTPUT @Nwa;"SEGM; OUTPACTI;"
1291   ENTER @Nwa_data1;Segment
1292   PRINT "Sweeping ";Input$;Segment
1293 END LOOP
1294  !
1295 REDIM Data(200,1)
1296 RETURN
1297  !
1298 Example25:      ! Learn String *****
1299 PRINT
1300 PRINT "Example 25, Learn String"
1301  !
1302 DISP "Initializing System"
1303 OUTPUT @Nwa;"PRES;"
1304 LOCAL @Nwa
1305 LINPUT "Set State to Save then Press Return.",Input$
1306 OUTPUT @Nwa;"OUTPLEAS;"          ! Always FORM1
1307 ENTER @Nwa_data2;Preamble,Size
1308 PRINT "Learn String Length=";Size;"Bytes"
1309 REDIM Learn_string(1:Size/2)     ! Size Depends Upon Firmware Version
1310 ENTER @Nwa_data2;Learn_string(*)
1311 OUTPUT @Nwa;"PRES;"
1312  !
1313 LINPUT "Press Return to Recall Previous Instrument State.",Input$
1314 OUTPUT @Nwa;"INPULEAS;"
1315 OUTPUT @Nwa_data2;Preamble,Size,Learn_string(*)
1316 RETURN
1317  !
1318 Example26:      ! Input Floating Point or ASCII Data *****
1319 PRINT
1320 PRINT "Example 26, Input Floating Point or ASCII Data"
1321  !
1322 GOSUB Blank_keys
1323 ON KEY 5 LABEL " NEXT EXAMPLE" GOSUB Finish
1324  !
1325 OUTPUT @Nwa;"HOLD; POIN201; SINC; S11; LIMP; ENT0;"
1326  !
1327 OUTPUT 716;"FORM3; OUTPDATA;"    ! Get Preamble and Size for Form 3 Input
1328 ENTER @Nwa_data2;Preamble,Size
1329 OUTPUT @Nwa;"ENT0;"

```

Programming Examples

```
1330  !
1331  DEG
1332  Again26:  !
1333  Finish=0
1334  Offset=0
1335  !
1336  LINPUT "ASCII OR FLOATING POINT? (Enter A or F)",Input$
1337  IF UPC$(Input$)="A" THEN
1338    PRINT "Input ASCII (FORM4;) Data"
1339    GOTO Input_ascii
1340  ELSE
1341    PRINT "Input Floating Point (FORM3;) Data"
1342  END IF
1343  !
1344  Input_fp:      ! Input Floating Point
1345  IF Finish=1 THEN GOTO Exit_example26
1346  GOSUB Compute_trace
1347  !
1348  OUTPUT @Nwa;"FORM3; INPUDATA;"
1349  OUTPUT @Nwa_data2;Preamble,Size,Data(*)
1350  GOTO Input_fp
1351  !
1352  Input_ascii:   ! Input ASCII
1353  IF Finish=1 THEN GOTO Exit_example26
1354  GOSUB Compute_trace
1355  !
1356  OUTPUT @Nwa;"FORM4; INPUDATA;";
1357  OUTPUT @Nwa_data1;Data_ascii$(*)
1358  !
1359  GOTO Input_ascii
1360  !
1361  Finish:  !      Must Finish ASCII Trace Before Exit
1362  Finish=1
1363  RETURN
1364  !
1365  Exit_example26:  !
1366  LINPUT "Repeat Example? (Enter Y or N)",Input$
1367  IF UPC$(Input$)="Y" THEN GOTO Again26
1368  GOSUB Keys_off
1369  RETURN
1370  !
1371  Compute_trace:  !
1372  Offset=Offset-10
1373  FOR I=0 TO 200
1374    Data(I,0)=SIN(2*I+Offset)
1375    Data(I,1)=COS(2*I)
1376  NEXT I
1377  FOR I=0 TO 200
1378    Data_ascii$(I,0)=VAL$(Data(I,0))
1379    Data_ascii$(I,1)=VAL$(Data(I,1))
1380  NEXT I
1381  RETURN
1382  !
1383  Example27:  !  DELAY TABLE OPERATIONS *****
1384  PRINT
1385  PRINT "Example 27, Delay Table Operations"
1386  !
1387  DISP "Initializing System"
1388  OUTPUT @Nwa;"PRES; LIMP; SING; AUTO; DATI; DISPMATH; MARK1;"
```

Programming Examples

```

1389 OUTPUT @Nwa;"FORM3; OUTPDATA;" ! current trace data is used for delay tbl.
1390 ENTER @Nwa_data2;Preamble,Size,Data(*) ! Get Data for Example
1391 !
1392 LINPUT "Press Return to Input Delay Table",Input$
1393 PRINT "Input Delay Table Data"
1394 OUTPUT @Nwa;"HOLD; FORM3; IMPUDELA;"
1395 OUTPUT @Nwa_data2;Preamble,Size,Data(*)
1396 !
1397 LINPUT "Press Return to Turn On Table Delay",Input$
1398 OUTPUT @Nwa;"TABD;"
1399 !
1400 LINPUT "Press Return to Turn Off Table Delay",Input$
1401 OUTPUT @Nwa;"COAD;" ! Or "WAVD;"
1402 !
1403 LINPUT "Press Return to Output Table Delay",Input$
1404 PRINT "Output Delay Table Data"
1405 OUTPUT @Nwa;"FORM3; OUTPDELA;"
1406 ENTER @Nwa_data2;Preamble,Size,Data(*)
1407 !
1408 LINPUT "Press Return to Store Delay Table to Disc",Input$
1409 PRINT "Store and Load Delay Table to Disc"
1410 OUTPUT @Nwa;"STOIINT; STOR; DELT; DISF""DELT"";"
1411 !
1412 LINPUT "Press Return to Load Delay Table form Disc",Input$
1413 OUTPUT @Nwa;"STOIINT; LOAD; DELT; DISF""DELT"";"
1414 RETURN
1415 !
1416 Example28: ! FASTCW Data Acquisition *****
1417 PRINT
1418 PRINT "Example 28, FASTCW Data Acquisition"
1419 !
1420 PRINT "Pulse Generator or External Trigger Source Required"
1421 LINPUT "Skip This Example? (Y or N)",Input$
1422 IF UPC$(Input$)<>"N" THEN GOTO Exit_example28
1423 LINPUT "Connect Pulse Gen or an external trigger source to 8510 EXT TRIGGER IN.",Input$
1424 !
1425 OUTPUT @Nwa;"PRES; CONT; SINP;"
1426 OUTPUT @Nwa;"CENT 10 GHz;" ! measurement frequency
1427 Again28: !
1428 GOSUB Blank_keys
1429 ON KEY 5 LABEL " NEXT EXAMPLE" GOSUB Exit_example28
1430 OUTPUT @Nwa;"FASC;"
1431 REPEAT ! WAIT UNTIL 8510 IS READY TO TAKE DATA.
1432 WAIT .001
1433 UNTIL BIT(SPOLL(@Nwa),2)
1434 !
1435 LINPUT "START PULSE GEN. OR EXTERNAL TRIGGER SOURCE THEN PRESS RETURN",Input$
1436 TRIGGER @Nwa ! ISSUE A SINGLE HPIB TRIGGER TO BEGIN FAST MODE.
1437 DISP "Collecting data, please wait..."
1438 !
1439 REDIM Form1_data(1:100,2) ! THE SIZE OF THIS ARRAY DETERMINES THE NUMBER
1440 ! OF POINTS MEASURED
1441 ENTER @Nwa_data2;Form1_data(*)! GET THE DATA, Continues when array is full
1442 !
1443 Data_collected: ! COLLECT DATA IN FORM 1 FORMAT.
1444 OUTPUT @Nwa;"SINP;" ! EXIT FROM FAST DATA MODE.
1445 OUTPUT @Nwa;"OUTPERRO;" ! CHECK ERROR STATUS.
1446 ENTER @Nwa_data1;Error_number,Input$

```

Programming Examples

```
1447 PRINT "8530A ERROR STATUS: ";Error_number,Input$
1448 PRINT SIZE(Form1_data,1);"Points Data Collected"
1449 !
1450 LINPUT "Press Return to Convert Data",Input$
1451 !
1452 ! This table is used to convert the exponent value from form1 data
1453 REAL Exp_tbl(0:255)
1454 Exp_tbl(0)=2^(-15) ! BUILD EXPONENT TABLE FOR DATA CONVERSION
1455 FOR I=0 TO 126
1456   Exp_tbl(I+1)=Exp_tbl(I)+Exp_tbl(I)
1457 NEXT I
1458 Exp_tbl(128)=2^(-143)
1459 FOR I=128 TO 254
1460   Exp_tbl(I+1)=Exp_tbl(I)+Exp_tbl(I)
1461 NEXT I
1462 !
1463 FOR N=1 TO SIZE(Form1_data,1) ! CONVERT THE DATA.
1464   Exponent=Exp_tbl(BINAND(Form1_data(N,2),255))
1465   Real=Form1_data(N,1)*Exponent
1466   Imag=Form1_data(N,0)*Exponent
1467   Lin_mag=20*LGT(SQRT(Real^2+Imag^2))
1468   IF N/20=INT(N/20) THEN PRINT "Point";N;") ";Lin_mag
1469 NEXT N
1470 !
1471 Exit_example28: !
1472 GOSUB Keys_off
1473 LINPUT "Repeat Example? (Enter Y or N)",Input$
1474 IF UPC$(Input$)<>"Y" THEN
1475   RETURN
1476 ELSE
1477   GOTO Again28
1478 END IF
1479 !
1480 Example29: ! Test Port Power Flatness Cal *****
1481 PRINT
1482 PRINT "Example 29, Test Port Power Flatness Cal"
1483 PRINT "8360 Series Source and Power Meter On System Bus Required"
1484 INPUT "Skip this example? (Enter Y or N)",Input$
1485 IF UPC$(Input$)<>"N" THEN RETURN
1486 !
1487 DISP "Initializing System"
1488 OUTPUT @Nwa;"PRES; POWE 0; POIN51; STAR 2GHZ; STOP 20GHZ; ENT0;"
1489 PRINT "Frequency Range, Number of Points and Leveled Power Set"
1490 INPUT "Zero Power Meter and Connect to Port 1 (Press Return)",Input$
1491 !
1492 OUTPUT @Nwa;"CLES; CALF;" ! Bit 4 Set When Complete
1493 DISP "Flatness Calibration in Progress ..."
1494 REPEAT
1495   WAIT .5
1496   Ser_poll=SPOLL(@Nwa)
1497   UNTIL BIT(Ser_poll,4) ! flatness cal complete
1498 !
1499 OUTPUT @Nwa;"POWE -15; FLATON;" ! set test port power
1500 PRINT "Flatness On, Source 1 Power is now power at Port 1"
1501 !
1502 OUTPUT @Nwa;"USER1; STEP; SING; DATI; MAGO -15;"
1503 OUTPUT @Nwa;" DISPMATH; MARK1; SCAL 5; CONT;"
1504 OUTPUT @Nwa;"DWET .5; POWE;" ! dwell slows sweep for power meter
```

Programming Examples

```

1505 PRINT "Change Source Power while Observing Trace AND Power Meter."
1506 LOCAL @Nwa
1507 RETURN
1508 !
1509 Example30: ! Receiver Power Cal *****
1510 PRINT
1511 PRINT "Example 30, Receiver Power Cal"
1512 PRINT "A Valid 2-20 Ghz Test Port Power Flatness Cal (Example 29)"
1513 PRINT "And 8510C Firmware >= Rev.C.07.00 Required."
1514 INPUT "Skip this example? (Enter Y or N)",Input$
1515 IF UPC$(Input$)<>"N" THEN RETURN
1516 DISP "Initializing System"
1517 OUTPUT @Nwa;"PRES; POIN101; STEP; STAR 2GHZ; STOP 20GHZ; MARK1; POWE -5; USER1;"
1518 INPUT "Connect Thru between Port 1 and Port 2 for Receiver Cal (Press Return)",Input$
1519 OUTPUT @Nwa;"CALRCVR; RCVO; RCVI; SAVR; CALS2;"
1520 OUTPUT @Nwa;"CHAN2; USER2; SPLI; MENUSTIM; SOFT1; SOFT8"
1521 LOCAL @Nwa
1522 PRINT "Calibrated DUT Input and Output Power now displayed (dbm)."

```

Programming Examples

```
1563 IF Input$="1" THEN GOSUB Example1
1564 IF Input$="2" THEN GOSUB Example2
1565 IF Input$="3" THEN GOSUB Example3
1566 IF Input$="4" THEN GOSUB Example4
1567 IF Input$="5" THEN GOSUB Example5
1568 IF Input$="6" THEN GOSUB Example6
1569 IF Input$="7" THEN GOSUB Example7
1570 IF Input$="8" THEN GOSUB Example8
1571 IF Input$="9" THEN GOSUB Example9
1572 IF Input$="10" THEN GOSUB Example10
1573 IF Input$="11" THEN GOSUB Example11
1574 IF Input$="12" THEN GOSUB Example12
1575 IF Input$="13" THEN GOSUB Example13
1576 IF Input$="14" THEN GOSUB Example14
1577 IF Input$="15" THEN GOSUB Example15
1578 IF Input$="16" THEN GOSUB Example16
1579 IF Input$="17" THEN GOSUB Example17
1580 IF Input$="18" THEN GOSUB Example18
1581 IF Input$="19" THEN GOSUB Example19
1582 IF Input$="20" THEN GOSUB Example20
1583 IF Input$="21" THEN GOSUB Example21
1584 IF Input$="22" THEN GOSUB Example22
1585 IF Input$="23" THEN GOSUB Example23
1586 IF Input$="24" THEN GOSUB Example24
1587 IF Input$="25" THEN GOSUB Example25
1588 IF Input$="26" THEN GOSUB Example26
1589 IF Input$="27" THEN GOSUB Example27
1590 IF Input$="28" THEN GOSUB Example28
1591 IF Input$="29" THEN GOSUB Example29
1592 IF Input$="30" THEN GOSUB Example30
1593 IF Input$="31" THEN GOSUB Example31
1594 GOTO Choice
1595 END IF
1596 STOP
1597 !
1598 Wait_loop:WAIT .01
1599 GOTO Wait_loop
1600 ! *****
1601 Blank_keys: ! erases all the softkeys
1602 FOR I=1 TO 8
1603 ON KEY I LABEL "" GOSUB Do_nothing
1604 NEXT I
1605 RETURN
1606 ! *****
1607 Do_nothing: !
1608 WAIT .01
1609 RETURN
1610 ! *****
1611 Keys_off: !
1612 FOR I=1 TO 8
1613 OFF KEY I
1614 NEXT I
1615 RETURN
1616 ! *****
1617 No_analyzer: !
1618 DISP " *** 8510 Not Responding *** Check HPIB. Program Terminated."
1619 BEEP 200,.2
1620 END
```

Operator's Check and Routine Maintenance

Operator's Check

The following system operation checks confirm that the system is functional and ready for performance verification or operation or both. These simple checks are optional and primarily serve to establish confidence in the integrity of the system.

Agilent 8510 Self-Test

Press the analyzer front panel TEST activator to run the self-test sequence. Observe the LCD/CRT for the following sequence:

TESTING

LOADING OPERATING SYSTEM

SYSTEM INITIALIZATION IN PROGRESS *(flashes quickly)*

SYSTEM INITIALIZATION IN PROGRESS

RECALLING INSTRUMENT STATE

The Instrument State recalled is exactly the same as a *factory preset* with the addition of resetting the display colors to their default values.

The LCD/CRT should show a trace similar to the figure below.

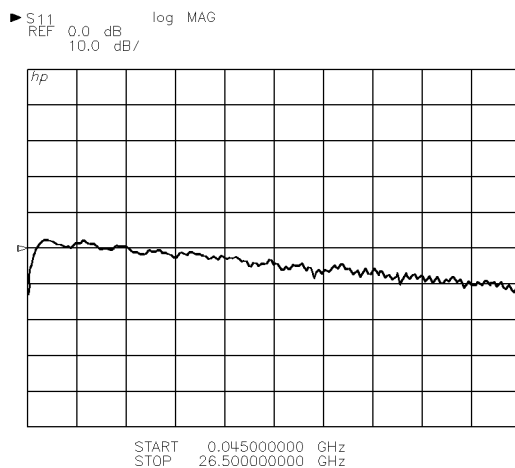

Figure 14-1. Typical Preset State Display

Programming Examples

S-Parameter Test Set Check

1. Press **(S12)** (PARAMETER area) to further confirm that the system is ready for performance verification or operation. The trace should drop to the bottom graticule of the display.
2. Press **(AUTO)** (RESPONSE area). The trace should reappear near the center of the display, probably with a change in scale.
3. Connect an RF cable to ports 1 and 2 of the test set. The trace should rise toward the top of the display.
4. Press **(AUTO)** again. The trace should reappear near the center of the display, probably with another change in scale.

This concludes the basic system tests. To thoroughly check the performance of the system, refer to the “Performance Verification” procedures. To operate the system, refer to the operating manual.

In Case of Difficulty

Incorrect operation can be indicated by:

- Error messages or error codes on the analyzer LCD/CRT.
- Abnormal system response or operation.

The most likely causes of problems for newly installed systems are poor cable connections or System Bus address errors.

Switch off the line power to all instruments and carefully recheck all cable connections and GPIB addresses, refer to the Installation section of the *On-Site Service Manual*. Then power-up the system instruments again in the correct sequence.

If the problem still exists, refer to the troubleshooting chapter of the *On-Site Service Manual* or contact your local Agilent customer engineer.

Routine Maintenance

Routine Maintenance consists of five tasks that should be performed at least every six months. If the system is used daily on a production line or in a harsh environment, the tasks should be performed more often. The tasks are:

- Maintain proper air flow.
- Inspect and clean connectors.
- Clean the glass filter and CRT (for CRT only).
- Degauss the display (for CRT only)
- Clean the LCD (for LCD only).
- Inspect the error terms.

Note The original 8510C Display/Processor incorporated a cathode ray tube (CRT).
 The current design incorporates a liquid crystal display.

Maintain Proper Air Flow

It is necessary to maintain constant air flow in and around your analyzer system. If the message, **CAUTION: Test Set is Too Hot!** is displayed, immediately inspect for items (a piece of paper for example) on the test set fan. Items on top of the test set or around the system may also impede the air flow. The test set *will not* shut down if it becomes too hot! If the Agilent 85101 or 85102 overheat, the system will shut down until the temperature drops to the operating range.

Additionally, it is recommended that the source fan filter (if any) be inspected once a week and cleaned as necessary.

Inspect and Clean Connectors

For accurate and repeatable measurement results, it is essential that connectors on calibration and verification devices, test ports, cables and other devices be cleaned and gaged regularly. It is also necessary that standard devices are handled and stored properly, and that all connectors are regularly inspected for signs of damage. This not only ensures the best performance from the connectors, but also extends their life. Refer to the calibration kit operating and service manuals and the *Microwave Connector Care Manual* shipped with the calibration kits, for a detailed description of microwave connector care techniques. These manuals also describe proper techniques for making connections.

Visually inspect the test port connectors. They should be clean and the center pin centered. If so, gage the microwave connectors (gages are supplied in Agilent calibration kits). Confirm that the recession is correct. Refer to the “Specifications” section in the test set manual for connector specifications.

Also inspect, clean, and gage the connectors of the calibration and verification kit devices. Refer to the kit manuals for center pin recession specifications.

Programming Examples

Cleaning the Test Set Rear-Panel Extensions

Over a period of time, the test set rear extensions can affect the performance of the analyzer system unless they, and the corresponding bulkhead connectors they are connected to, are kept clean. Use a foam swab and alcohol to clean the rear extensions and the bulkhead connectors. Be careful not to damage the center conductors of the bulkhead connectors.

Notice that these bulkhead connectors provide a direct path to the samplers. The appropriate static precautions, as outlined in the test set manual, should be used to prevent damage to the static-sensitive samplers.

Cleaning the Glass Filter and CRT

A gasket between the CRT and glass filter limits air dust infiltration between them. Therefore, cleaning the outer surface of the glass filter is usually sufficient. Use a soft cloth and, if necessary, a cleaning solution recommended for optical coated surfaces: part number 8500-2163 is one such solution.

If, after cleaning the outer surface of the glass filter, the CRT appears dark or dirty or unfocused, clean the inner surface of the filter and the CRT.

1. Remove the softkeys cover (a plastic cover through which the front panel softkeys protrude): *carefully* insert a thin, flat screwdriver blade (or your fingernail) between the upper left corner of the softkeys cover and the glass filter. See Figure 14-2. Be extremely careful not to scratch or break the glass. Carefully pull the cover forward and off.
2. Remove the two screws that are now uncovered.

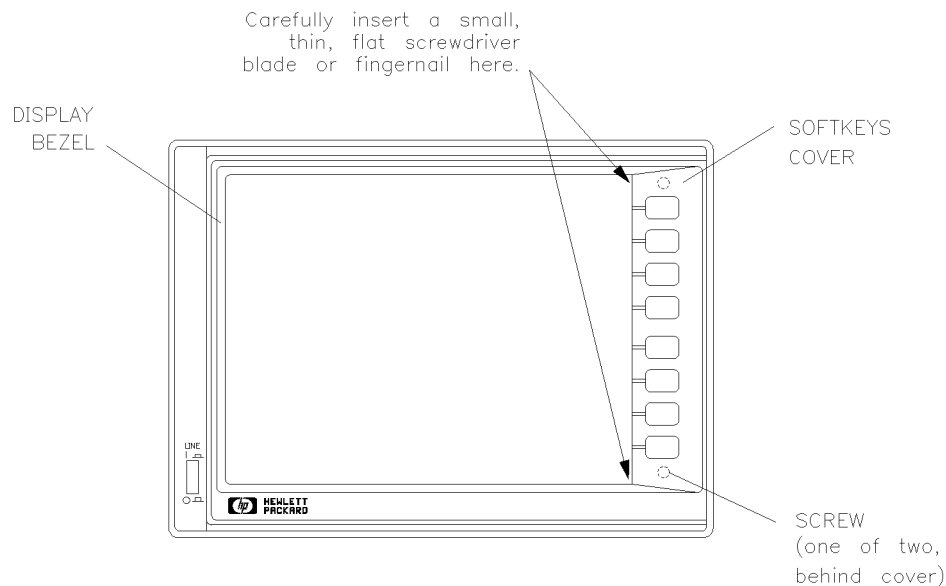

Figure 14-2. Removing the Glass Filter

3. Remove the display bezel assembly by pulling out the end that is now free. Pivot the bezel around its left edge until it is released.
4. Clean the CRT surface and the inner glass filter surface gently, as in step 1.
5. Allow the surfaces to dry and then reassemble the instrument.

4 Operator's Check and Routine Maintenance

Cleaning the LCD

Use a soft cloth and, if necessary, a cleaning solution recommended for optical coated surfaces. Agilent part number 8500-2163 is one such solution.

Degauss (Demagnetize) the Display (CRT Only)

If the display becomes magnetized, or if color purity is a problem, cycle the power several times. Leave the instrument off for at least 15 seconds before turning it on. This activates the automatic degaussing circuit in the analyzer display. If this is insufficient to achieve color purity, a commercially available demagnetizer must be used (either a CRT demagnetizer or a bulk tape eraser can be used). Follow the manufacturer's instructions keeping in mind the following: it is imperative that at first it be placed no closer than 4 inches (10 cm) from the face of the CRT while demagnetizing the display. If this distance is too far to completely demagnetize the CRT, try again at a slightly closer distance until the CRT is demagnetized. Generally, degaussing is accomplished with a slow rotary motion of the degausser, moving it in a circle of increasing radius while simultaneously moving away from the CRT.

Caution Applying an excessively strong magnetic field to the CRT face can destroy the CRT.

Like most displays, the CRT can be sensitive to large magnetic fields generated from unshielded motors. In countries that use 50 Hz, some 10 Hz jitter may be observed. If this problem is observed, remove the device causing the magnetic field. Figure Figure 14-3 shows the motion for degaussing the display.

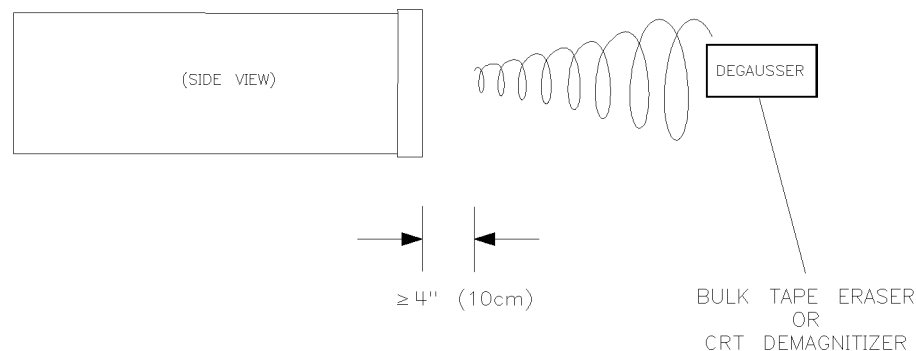

Figure 14-3. Motion for Degaussing the Display

Inspect the Error Terms

Error terms (E-terms or calibration coefficients) are an indication of the condition of the instrument, its calibration kits, and cables. When tracked over a period of time, error terms can signal and identify system component and performance degradation. Error term comparisons are best made with data generated periodically by the same system and calibration kit (the kit normally used with the analyzer). For this reason, generating error terms at the time of installation and at regular intervals thereafter is recommended.

A log book can be a helpful to store the error term plots. Error term plots are generated by performing the verification procedure.

Programming Examples

Refer to the Measurement Calibration chapter for information on how to perform a full 2-port or TRL 2-port calibration. To inspect the error terms or compare them to typical values, refer to “Error Terms” in the *8510C On-Site Service Manual*.

Index

1

- 1-Port calibration, performing, 8-19
- 1-port calibration, S11, program example, 13-22

3

- 35741/42 external monitor, 4-9

7

- 7550B or 7550 Plus plotters, how to make them function properly, 6-23

8

- 8510
 - description of, 3-3
 - how it makes measurements, 3-4
 - system description, 1-1
- 8511 test set, 3-10

A

- a_1 , 3-4
- a_2 , 3-4
- accessories, 3-11
 - extension lines, 3-11
 - source output to test set input signal cable, 3-11
 - test port return cables, 3-11
- accuracy
 - and connection quality, 2-4
- accuracy errors
 - caused by worn or unstable cables and connectors, 3-11
- accuracy, power, and dynamic range considerations, 4-57
- acquisition cycle of data, 4-68
- active function output, program example, 13-19
- adapters, 3-13
- addresses, assignment of, 5-8
- address menu, 1-16
- adjust colors, 4-6
- admittance display format, 4-25
- admittance measurement, 10-5
- air flow, 14-3
- always coupled, definition of, 1-9
- always uncoupled, definition of, 1-9
- annotations, 1-6

- annotations, adding to the screen, 6-3
- aperture, 9-11
 - and phase slope, 9-12
 - and smoothing, 9-12
 - versus resolution and noise, 9-12
- applying connector compensation, 8-37
- array, corrected data, 13-6
- array, formatted data, 13-7
- array, raw data, 13-6
- ASCII data format (CITIfile), 7-2
- attenuator, changing attenuation setting, 4-59
- attenuator port 1 and 2, 4-59
- attenuator, test set, 4-59
- audio annunciator (beeper), 5-5
- auto feed on/off, 6-23
- AUTO FEED ON/OFF softkey, 6-23
- automatic display reference feature, 2-6
- automatic display scale feature, 2-6
- automatic recall of instrument settings, 3-15
- averaging, 4-50
- averaging, recommended values, 4-51

B

- b_1 , 3-4
- b_2 , 3-4
- background intensity, 4-6
- BACKSPACE** key, 1-8
- balancing the reference and test signal paths, 3-11
- beeper, 5-5
- binary data format, 7-2
- blocked air flow, 14-3

C

- cable
 - for external monitor, 4-9
- cal coefficients, inspection of, 14-5
- calibration, **8-1**
 - coupling or uncoupling channels, 8-3
 - doing a measurement cal, 8-5
 - main menu structure, 8-4
 - measurement correction data creation, 8-2
 - measuring in time domain, time lowpass frequencies, 8-6
 - performing a 1-Port calibration, 8-19
 - performing a Full 2-Port calibration, 8-22

- performing a Response and Isolation calibration, 8-18
- performing a TRL 2-Port calibration, 8-24
- performing Frequency Response calibrations, 8-16
- principles and care of calibration standards, 8-27
- reflection/transmission test set calibration, 8-25
- requirements, 8-2
- saving/storing and register capacity, 8-14
- settings that should not be changed, 8-2
- transmission frequency (S_{21}) response calibration, 2-8
- turning on an existing calibration, 8-4
- tutorial, 2-7
- types applicable to reflection measurements, 10-1
- types applicable to transmission measurements, 9-3
- types of calibrations and their uses, 8-6
- using averaging, 8-3
- using connector compensation, 8-37
- using required standards, 8-9
- using **RESUME CAL SEQUENCE**, 8-5
- verifying your calibration, 8-29
- calibration coefficient data arrays, 13-7
- calibration, IF, 5-5
- calibration kit (cal kit), 2-7
- calibration kits, 3-13
- calibration standards, principles and care of, 8-27
- CAL KITS softkey, 7-4
- CAL SET 1-8 softkey, 7-4
- CAL SET ALL softkey, 7-4
- cal type change, 8-36
- Cartesian display formats, 4-25
- caution message
 - test set too hot, 14-3
- caution/tell messages, reading and outputting, program example, 13-32
- central processing unit and memory description, 3-5
- change cal type, 8-36
- change ca; set, 8-32
- channel 1 and 2 data processing, **13-5**
- channel coupling, 1-9
- channel coupling, stimulus settings, 4-66
- channel selection, 1-9
- chirp-Z transform, 3-5
- CITIfile data format, 7-2
- cleaning connectors, 14-3
- cleaning the CRT, 14-4
- cleaning the LCD, 14-5
- clock adjust, 1-13, 5-6

- codes, GPIB programming, 13-2
- color, 4-6
- color of plotter pens, selecting, 6-23
- color printing, 6-13
- COLOR softkey, 6-13
- compatible instruments and peripherals, 1-1
- configuring a printer
 - laser printer, 6-6
- connecting the 8510C to a computer, 13-4
- connector care and use, proper, 3-13
- connector compensation, cal set modifications, 8-36
- connector pairs for compensation, 8-36
- connector savers, 3-13
- connectors, care of, 2-4
- connectors, maintenance of, 14-3
- connector torque, 3-13
- CONSTANT FREQUENCY softkey, 5-13
- contacting Agilent, v
- controlling LO sources, 5-11
- controlling multiple sources, 5-11
- conventions, typeface, vii
- copolar and crosspolar measurements, problems
 - with (IF overload error), 5-20
- corrected data array, 13-6
- corrected measurement data arrays, 13-5
- correcting entry errors, 4-56
- correction, IF, 5-5
- coupling stimulus settings between channels, 4-66
- crosspolar and copolar measurements, problems
 - with (IF overload error), 5-20
- CRT, cleaning of, 14-4
- CRT colors, 4-6
- CRT, demagnetizing of, 14-5
- CRT intensity, 4-5
- CRT OFF softkey, 5-7
- custom test set, 3-10
- custom test sets, using, 4-41
- cycle of data acquisition, 4-68

D

- D1191A cable for external monitors, 4-9
- data acquisition cycle, 4-68
- data array, corrected, 13-6
- data array, formatted, 13-7
- data array, raw, 13-6
- data arrays, 3-5
- data file formats, 7-2
- DATA RAW softkey, 7-5
- DATA softkey, 7-5
- data transfer formats (Form 1 through 5), 13-8
- date/time clock, adjust, 1-13, 5-6
- DATE/TIME FUNCTIONS softkey, 5-6

- date/time plot, 6-22
- date/time printout, 6-4
- DEFAULT PEN NUMBERS softkey, 6-24
- DEFAULT softkey, 5-13
- DEFINE PLOT softkey, 6-23
- DEFINE PRINT softkey, 6-6, 6-10, 6-12, 6-14
- DEFINE RECEIVER softkey, 5-15
- DEFINE SOURCE 1 softkey, 5-15
- DEFINE SOURCE 2 softkey, 5-13
- degauss CRT, 14-5
- delay display format, 4-25
- delay, electrical, 4-53
- delay table data array, 13-7
- delay table, program example, 13-36
- DELAY TABLE softkey, 7-5
- deleting disk files, 7-8
- delta marker modes, program example, 13-21
- delta markers, 4-33
- demagnetize the display, 14-5
- DeskJet family printers, using, 6-10
- Deviation from Linear Phase, 3-2
- deviation from linear phase measurement, 9-12
- difficulties in operation, 14-2
- digital signal processing, 3-5
- directory, viewing disk files, 7-7
- discs, compatible types, 7-1
- discs, formatting, 7-3
- discs, initializing, 7-3
- disk drive (external) unit and volume number, 7-9
- disk drive operation, 7-1
- disk drive, using an external drive, 7-8
- disk files
 - deleting, 7-8
 - directory function, 7-7
 - loading, 7-6
 - storing, 7-4
 - un-deleting, 7-8
- disk storage capacity, 7-1
- disk storage, program example, 13-25
- disk store and load, program examples, 13-37
- disk utilities
 - initializing a hard disc, 7-9
- display
 - change colors, 4-6
 - marker lists, 4-31
- display features, 1-3
- display format, changing, 2-6
- display functions, 4-1ff
- display messages, 1-5
- display modes, 4-2
- display modes, program example, 13-22
- display scale and reference, automatic, 2-6
- display scale and reference, changing, 2-6
- display titles, 1-5

- DOS and LIF disk formats, 7-3
- DOS disk format, changing to, 7-3
- dual channel displays, 4-3
- dual channel mode, 4-67
- duplicate frequency list points, eliminating, 4-71
- dwelt time, 4-64
- dynamic range considerations, 4-46
- dynamic range, power, and accuracy considerations, 4-57

E

- EDIT MULT. SRC. softkey, 5-11
- EIA standard RS-330, 4-9
- electrical delay, 4-53
 - auto, 4-54
 - automatically balancing test and reference inputs, 4-54
 - coaxial mode, 4-54
 - entering delay values over GPIB, 4-54
 - purpose of, 4-54
 - setting velocity factor, 4-54
 - waveguide mode, 4-54
- Electrical Delay and Electrical Length, 3-2
- enhancement labels (symbols and annotations), 1-6
- entry block, description, 1-7
- error messages
 - IF OVERLOAD, 5-20
- errors, correcting entry errors, 4-56
- error terms, inspection of, 14-5
- estimating test port signal level, 4-57
- extension cables, test port, 3-11
- extension lines
 - description of, 3-11
 - using with reflection/transmission test sets, 3-13
 - using with S-parameter test sets, 3-13
- external disk drive, using, 7-8
- EXTERNAL DISPLAY connector, 4-9
- external trigger, 4-68
- external video , 4-9

F

- factory preset
 - definition of, 1-15
 - how to do, 1-13
- fast CW, program examples, 13-36
- fault location measurement using time band pass, 11-5
- files
 - deleting, 7-8
 - directory function, 7-7
 - un-deleting, 7-8
- flatness calibration in receiver cal, 12-4
- flatness correction, 4-60

flow of air, 14-3
 FORM 1 data conversion, program example, 13-22
 Form 1 data transfer format, 13-8
 Form 2 data transfer format, 13-8
 FORM 3 and FORM 4, program example, 13-35
 Form 3 data transfer format, 13-8
 Form 4 data transfer format, 13-8
 Form 5 data transfer format, 13-8
 FORMAT
 selecting display format, 2-6
 format functions, 4-25-28
 FORMAT, keys, 1-11
 formatted data array, 13-7
 formatted measurement data arrays, 13-5
 FORMATTED softkey, 7-5
 formatting discs, 7-3
 formatting (initializing) a hard disc., 7-9
 FORM FEED softkey, 6-23
 Fourier Transform, 3-2
 four parameter displays, 4-5
 frequency domain example measurement sequence, 2-3
 frequency domain measurements, 2-9
 frequency list
 deleting duplicate measurements, 4-71
 frequency list, program example, 13-34
 frequency list, save and recall, 4-71
 frequency lists, creating and editing, 4-69
 frequency list sweep mode, 4-63
 FREQUENCY OFF softkey, 5-7
 frequency parameters, setting of, 4-56
 Frequency Response calibration, performing, 8-16
 frequency zoom, 8-32
 Full 2-Port calibration performing, 8-22

G

G/n key, 1-8
 GPIB addresses, 5-8
 GPIB address menu, 1-16
 GPIB address settings, 13-4
 GPIB interface (system bus), selecting for printer or plotter, 6-2
 GPIB interface, use with printers and plotters, 6-2
 GPIB programming, 13-1
 active function output, 13-19
 caution/tell messages, reading and outputting, 13-32
 codes, 13-2
 debugging, 13-17
 delta marker modes, 13-21
 disk storage, 13-25
 disk store and load, 13-37

display modes, 13-22
 dynamic array allocation, 13-10
 example programs, 13-18
 fast CW modes, 13-36
 FORM1 data conversion, 13-22
 FORM 3 and FORM 4, 13-35
 format of data output to the computer, 13-16
 frequency list, 13-34
 GPIB triggered data acquisition, 13-34
 HP-GL graphics, 13-29
 key code output, 13-34
 learn string, 13-35
 listener-only commands, 13-39
 list of executable examples, 13-40
 marker data output, 13-20
 mnemonics, 13-2
 numeric entries and units terminators, 13-3
 order of commands, 13-2
 outputting the current active function value, 13-16
 outputting the current system state, 13-16
 pass-through mode, 13-27
 pass-through to
 system bus instruments/peripherals, 13-27
 plotting, 13-26
 printing, 13-26
 printing tabular data, 13-27
 printing your own messages on the display, 13-26
 reading marker values in dual channel modes, 13-21
 receiver power cal, 13-36
 redefine parameters, 13-32
 S11 1-port and S21 response calibrations, 13-22
 status bytes, 13-32
 syntax information, 13-18
 table delay, 13-36
 test port power flatness calibration, 13-36
 timing considerations, 13-3
 trace data output and input, 13-22
 transferring trace data to network analyzer memory, 13-14
 universal commands, 13-39
 user display graphics, 13-29
 user graphics, 13-29
 using =MARKER, 13-21
 wait not required, 13-34
 wait required, 13-34
 GPIB triggered data acquisition, program example, 13-34
 GPIB USES FACTORY PRESET softkey, 5-9
 GPIB USES USR PRESET softkey, 5-9
 graphics (user) plotting, program example, 13-29

Group Delay, 3-2
group delay aperture, 9-11
 and phase slope, 9-12
 and smoothing, 9-12
 versus resolution and noise, 9-12
group delay, measuring, 9-10

H

hard disc, initializing, 7-9
hardware state defined, 3-17
HARDWARE STATE softkey, 7-5
harsh environments and maintenance, 14-3
hierarchical memory of instrument settings, 3-15
HP 7550B or 7550 Plus plotters, how to make
 them function properly, 6-23
HP DeskJet 500C or 550C Printer, trouble when
 attempting to print, 6-10
HP DeskJet family printers, using, 6-10
HP-GL graphics, plotting, program example,
 13-29
HP PaintJet, and PaintJet XL printers, using,
 6-11
HP PaintJet, and PaintJet XL printer switch
 settings, 6-11
HP QuietJet and QuietJet Plus printer switch
 settings, 6-11
HP QuietJet and QuietJet Plus, using, 6-11

I

IF calibration, 5-5
IF calibration (correction) controls, 5-5
IF correction, 5-5
IF CORRECTION softkey, 5-5
IF Gain, 5-20
IF Gain controls, automatic and manual, 5-20
IF GAIN softkey, 5-20
IF OVERLOAD, error message, 5-20
imaginary display format, 4-25
Impedance, 3-2
impedance measurement, 10-5
initializing a hard disc, 7-9
initializing discs, 7-3
input channels, 3-4
insertion loss and phase angle, measuring, 2-10
Insertion Loss or Gain, 3-2
insertion loss or gain, measuring, 9-6
insertion phase, measuring, 9-8
installation, printer, 6-4
instrument factory preset conditions, 3-16
instruments, compatible, 1-1
instrument settings, automatic recall of, 3-15
instrument state, limited, 4-49
instrument states, saving and recalling, 1-15
INST STATE 1-8 softkey, 7-4
INST STATE ALL softkey, 7-4

intensity, CRT, 4-5
intensity, LCD, 4-5
internal trigger, 4-68
introduction to basic network measurements,
 3-1
inverted Smith chart display format, 4-25

K

key code output, program example, 13-34
(k/m) key, 1-8

L

landscape printer mode, 6-17
landscape printing orientation, 6-16, 6-17
laser printer configuration, 6-6
laser printers, using, 6-6
LCD, cleaning of, 14-5
LCD intensity, 4-5
learn string (using), program example, 13-35
learn sweep, defined, 4-62
LEFT LOWER softkey, 6-27
LEFT UPPER softkey, 6-27
leveling power, 5-9
LIF and DOS disk formats, 7-3
LIF disk format, changing to, 7-3
limited instrument state, 1-14, 4-49
limited instrument state memory, 3-15
limit points, 4-11
limits, 4-11
linear magnitude display format, 4-25
lines of limits, 4-11
LIST ALL PARAMETERS softkey, 6-18
listing, programming examples, 13-40
LIST ONE PARAMETER softkey, 6-18
LIST PARAMETERS softkey, 6-20
list skip factor, 6-19
LIST SKIP FACTOR softkey, 6-19
lists, markers display of, 4-31
LIST TRACE VALUES softkey, 6-18
loading disk files, 7-6
loading instrument data from disk, 7-1
loading the network analyzer operating system
 from disc, 5-19
(LOCAL) key, 1-16
LOCAL menu, 5-8
lock and roll, 3-6
lock speed, 5-4
LOCK SPEED FAST softkey, 5-4
LOCK SPEED NORMAL softkey, 5-4
lock type, 5-3
LOCK TYPE EXTERNAL softkey, 5-3
LOCK TYPE INTERNAL softkey, 5-3
LOCK TYPE NONE softkey, 5-3
log magnitude display format, 4-25

LO source configuration, 5-11

M

MACHINE DUMP softkey, 7-5

magnitude offset, 4-55

magnitude slope, 4-55

maintenance of the analyzer system, 14-3

making connections properly, 2-4

marker data output, program example, 13-20

marker functions, 4-29-37

marker list plots, 6-22

marker list prints, 6-4

marker lists, 4-31

markers

continuous, 4-31

delta markers, 4-33, **4-36**

discrete, 4-31

making a marker the active marker, 4-29

marker to maximum, 4-34

marker to minimum, 4-34

marker to target, 4-34

moving the marker continuously or by discrete measurement points, 4-31

search modes, 4-34

search right and left, 4-35

setting the reference to the value at the active marker, 1-8

setting the sweep with markers, 4-57

units, 4-30

using, 4-29

markers, removing all markers from the display, 4-30

math co-processor, 3-5

maximum value, finding, 9-7

may be uncoupled, definition of, 1-9

measurement display custom titles, 1-5

measurement inputs, selecting, 2-6

measurement (**RESTART**), 1-12

measurement sequence, tutorial, 2-1

measurement signal processing, 3-5

measuring 3 dB frequencies, 9-6

measuring admittance, 10-5

measuring deviation from linear phase, 9-12

measuring group delay, 9-10

measuring impedance, 10-5

measuring insertion loss and gain, 9-6

measuring insertion phase, 9-8

measuring maximum and minimum values, 9-7

measuring reflection S-parameters, 10-4

measuring return loss, 10-3

measuring SWR, 10-3

measuring transmission S-parameters, 9-9

MEMORY 1-8 softkey, 7-4

MEMORY ALL softkey, 7-4

memory data array, 13-7

memory description, 3-5

memory of instrument settings, automatic, 3-15

memory, previous settings, 1-14

menu keys (in each functional group), description of, 1-10

menus, plotting of, 6-22

menus, printing of, 6-4

message areas, 1-3

Microwave Design System, 7-2

minimum value, finding, 9-7

(M/μ) key, 1-8

mnemonics, GPIB programming, 13-2

modify cal sets, 8-32

modify display colors, 4-7

monitors, external video, 4-9

multiple source menu, 5-11

multiple source mode, 5-11

multiple sources, controlling, 5-11

MULTIPLIER DENOM. softkey, 5-13

MULTIPLIER NUMER. softkey, 5-13

MULT. SRC ON / SAVE softkey, 5-13

N

network analyzer principles of operation, 3-1

network analyzer system description, 1-1

network measurements, introduction to, 3-1

noise reduction techniques, 4-50

non-HP printers, using, 6-15

normal step mode, 5-3

number of groups, purpose of, 4-66

number of points and frequency resolution, 4-61

number of points, selecting, 4-61

numeric keys, description, 1-7

O

OFFSET FREQUENCY softkey, 5-13

OPERATING PARAMETERS softkey, 6-20

operating system, loading from disc, 5-19

operating system, storing to disc, 5-19

operation difficulties, 14-2

overheating, 14-3

overlay displays

dual channel, 4-3

four parameter, 4-5

P

PaintJet, and PaintJet XL printers, using, 6-11

PaintJet, and PaintJet XL printer switch settings, 6-11

parameter

four parameters display of, 4-5

single display of, 4-2

PARAMETER

selecting, 2-6

- parameter functions, 4-38–47
- PARAMETER, keys, 1-11
- parameter, redefining, 4-41
- parameters, redefining, program example, 13-32
- parameters, user, 4-40
- pass-through mode, program example, 13-27
- Peek/Poke, 5-23
- pen color, selecting, 6-23
- periodic maintenance, 14-3
- peripherals, compatible, 1-1
- phase display format, 4-25
- phaselock controls, 5-3
- phase offset, 4-54
- PLOT ALL FOUR PARAMETERS softkey, 6-26
- PLOT ALL softkey, 6-26
- plot buffer, 6-3
- PLOT DATA softkey, 6-26
- PLOT GRATICULE softkey, 6-26
- PLOT MARKERS(S) softkey, 6-26
- PLOT MEMORY softkey, 6-26
- plot menus, 6-22
- PLOT PARAMETERS softkey, 6-20
- plotter interfaces, supported, 6-2
- plotter pen color, selecting, 6-23
- plotters, using the HP 7550B or 7550 Plus properly, 6-23
- PLOT TEXT softkey, 6-26
- plotting, 6-25
- plotting a 1/4 size snapshot in a selected page quadrant, 6-26
- plotting categories, 2-11
- plotting four snapshots per page, 6-26
- plotting individual display components, 6-26
- plotting options, 6-23
- plotting, program example, 13-26
- plotting the entire display, 6-26
- plotting user graphics, program example, 13-29
- PLOT TITLE softkey, 6-26
- PLOT TO PLOTTER softkey, 6-26
- PLOT TYPE COLOR softkey, 6-23
- PLOT TYPE MONOCHROME softkey, 6-23
- points of limits, 4-11
- Poke, 5-23
- polar display formats, 4-25
- portrait printer mode, 6-17
- portrait printing orientation, 6-16, 6-17
- power, accuracy, and dynamic range considerations, 4-57
- power, compensating for power loss at high frequencies with power slope, 4-59
- power domain, **12-1**
 - completing a receiver cal, 12-4
 - flatness calibration procedure, 12-4
 - function description, 12-1
 - measurement units and parameter labels, 12-6
 - receiver calibration, 12-2
 - using the menu keys, 12-3
- power leveling, 5-9
- power on sequence, 2-2
- power, setting, 4-57
- power slope, using, 4-59
- precautions when changing addresses of System Bus Instruments, 5-8
- precautions when changing RF or LO sources on the System Bus, 5-8
- PRES command, 5-9
- preset
 - factory, definition of, 1-15
 - factory how to do, 1-13
- presetting the 8510, 2-5, 3-16
- principles of operation, network analyzer, 3-1
- print buffer, 6-3
- printer configuration
 - HP DeskJet, DeskJet Plus, or DeskJet 500 or 550 Series printers, 6-10
 - HP PaintJet and PaintJet XL printers, 6-11
 - HP QuietJet and QuietJet Plus printers, 6-11
 - HP ThinkJet printer, 6-13
 - laser printer, 6-6
 - laser printers, 6-6
 - non-HP printers, 6-15
- printer installation, 6-4
- printer interfaces, supported, 6-2
- PRINTER RESOLUTION of Analyzer, 6-12
- PRINTER RESOLUTION softkey, 6-6, 6-10, 6-14
- printing
 - landscape, 6-16, 6-17
 - portrait, 6-16, 6-17
- printing in color, 6-13
- printing instrument settings and system configuration, 6-20
- printing one snapshot per page, 6-17
- printing tabular measurement data, 6-18
- printing two snapshots per page, 6-17
- PRINT LANDSCAPE softkey, 6-16, 6-17
- PRINT PORTRAIT softkey, 6-16, 6-17
- print resolution setting
 - for HP DeskJet family printers, 6-10
 - for HP PaintJet and PaintJet XL Printers, 6-12
 - for HP QuietJet and QuietJet Plus Printers, 6-12
 - for HP ThinkJet printer, 6-14
 - for laser printers, 6-6
- problems in operation, 14-2
- programming codes, 13-2
- programming example listing, 13-40
- programming examples

- active function output, 13-19
- caution/tell messages, reading and outputting, 13-32
- delta marker modes, 13-21
- disk storage, 13-25
- disk store and load, 13-37
- display modes, 13-22
- fast CW modes, 13-36
- FORM1 data conversion, 13-22
- FORM 3 and FORM 4, 13-35
- frequency list, 13-34
- GPIB triggered data acquisition, 13-34
- HP-GL graphics, 13-29
- key code output, 13-34
- marker data output, 13-20
- pass-through mode, 13-27
- plotting, 13-26
- printing tabular data, 13-27
- receiver power cal, 13-36
- redefine parameters, 13-32
- S11 1-port and S21 response calibrations, 13-22
- status bytes, 13-32
- syntax information, 13-18
- table delay, 13-36
- test port power flatness calibration, 13-36
- trace data output and input, 13-22
- user graphics, 13-29
- using =MARKER, 13-21
- using the learn string, 13-35
- wait not required, 13-34
- wait required, 13-34
- programming mnemonics, 13-2
- programming over GPIB, 13-1

Q

- query system state, 13-16
- quick step mode, 5-4
- QuietJet and QuietJet Plus printer switch settings, 6-11
- QuietJet and QuietJet Plus, using, 6-11

R

- ramp sweep, definition of, 3-4
- ramp sweep, description of, 3-6
- ramp sweep mode, 4-62
- ramp sweep, sampling during, 3-4
- ratio measurements, description of, 3-4
- raw data, 13-6
- raw data array, 13-6
- raw measurement data arrays, 13-5
- real display format, 4-25
- real-time annotations and plots, 6-22
- real-time annotations and printouts, 6-4
- recalling instrument states, 1-15

- receiver power cal, program examples, 13-36
- redefine parameter, 3-10, 4-41
- redefine parameters, program example, 13-32
- Reflection Coefficient, 3-2
- reflection measurement examples, 10-1
- reflection measurements
 - description of, 3-1
 - types of measurement results, 3-2
- reflection/transmission test set, 3-8
- reflection/transmission test set calibration, 8-25
- reloading the network analyzer operating system
 - from disc, 5-19
- repeatability and connection quality, 2-4
- RESET IF CORRECTION softkey, 5-5
- resolution setting
 - for HP DeskJet family printers, 6-10
 - for HP PaintJet and PaintJet XL Printers, 6-12
 - for HP QuietJet and QuietJet Plus Printers, 6-12
 - for HP ThinkJet printer, 6-14
 - for laser printers, 6-6
- RESPONSE
 - changing display scale and reference, 2-6
- Response and Isolation calibration, performing, 8-18
- response calibration, S21, program example, 13-22
- response functions, 4-48-55
- RESPONSE, keys, 1-11
- restart, measurement, 1-12
- RESTORE DISPLAY softkey, 6-20
- return cables, test port, 3-11
- Return Loss, 3-2
- return loss and phase angle, measuring, 2-9
- return loss measurement, 10-3
- RF power, accuracy, and dynamic range
 - considerations, 4-57
- RF sources, 3-6
- RF source, setting power, 4-57
- RIGHT LOWER softkey, 6-27
- RIGHT UPPER softkey, 6-27
- RS-232 interface, use with printers and plotters, 6-2
- RS-232 PORT #1 softkey, 6-4, 6-22
- RS-232 PORT #2 softkey, 6-4, 6-22

S

- S₁₁, 3-8, 3-9
- S11 and S21 calibrations, program example, 13-22
- S₁₁ key, 4-38
- S₁₂, 3-8, 3-9
- S₁₂ key, 4-38

- S₂₁, 3-8, 3-9
- S₂₁ key, 4-38
- S₂₂, 3-8, 3-9
- S₂₂ key, 4-38
- sampling details, 3-4
- save and recall feature, added benefit over the automatic settings memory (limited instrument state), 3-15
- Saving instrument data to disk, 7-1
- saving instrument states, 1-15
- screen annotations, adding to the screen, 6-3
- search modes, markers, 4-34
- security features, 5-7
- select quadrant, 6-23
- SELECT QUADRANT softkey, 6-27
- selftest, 14-1
- self-test and initialization, 2-3
- serial interface, 6-2
- serial interface, selecting for printer or plotter, 6-2
- service functions, 5-18
- SERVICE FUNCTIONS softkey, 5-18
- service test menu, 5-18
- SET DAY softkey, 5-6
- SET MONTH softkey, 5-6
- SET PEN NUMBERS softkey, 6-23, **6-23**
- settings, automatic memory of measurement settings, 1-14
- settings, automatic recall of, 3-15
- setting test port signal level, 4-57
- setting the time and date, 5-6
- SET YEAR softkey, 5-6
- signal levels at test ports, estimating, 4-57
- signal levels at test ports, setting, 4-57
- signal processing, 3-5
- single channel displays, 4-2
- single point sweep mode, 4-62
- skip factor, 6-19
- Smith chart display format, 4-25
- smoothing, 4-50, **4-52**
- snapshot, plotting, 6-26
- snapshot, printing, 6-17
- softkey menu general description, 1-6
- softkey menus, general description and explanation of special markings, 1-10
- SOFTWARE REVISION softkey, 5-23
- SOURCE 1 EXT. LEVEL softkey, 5-9
- SOURCE 1 INTERNAL softkey, 5-9
- SOURCE 1 MM MODULE softkey, 5-9
- source, setting power, 4-57
- S-parameters, definitions and conventions, 4-38
- S-parameters, measuring reflection, 10-4
- S-parameters, measuring transmission, 9-9
- S-parameter test set, 3-9
- speed comparison, step and frequency list versus ramp mode, 4-63
- split displays
 - dual channel, 4-3
 - four parameters, 4-5
- SRQ, 13-16
- Standing Wave Ratio (SWR), 3-2
- start frequency, setting, 2-5
- static discharge, consequences of, 2-4
- status bytes, program example, 13-32
- step attenuator, changing attenuation setting, 4-59
- step attenuator, test set, 4-59
- step sweep, definition of, 3-4
- step sweep mode, 4-62
- step sweep mode, description of, 3-7
- step sweep, sampling during, 3-4
- step type, 5-3
- STEP TYPE NORMAL softkey, 5-3
- STEP TYPE QUICK softkey, 5-3
- step (up and down) keys, description, 1-7
- STIMULUS
 - coupling settings between channel 1 and 2, 4-66
 - examples of use, 2-5
 - settings than can be uncoupled between channels, 4-67
 - settings than cannot be uncoupled between channels, 4-66
 - uncoupling settings between channel 1 and 2, 4-66
- stimulus functions, 4-56-59
- STIMULUS, keys, 1-11
- stimulus power, setting, 4-57
- stop frequency, setting, 2-5
- storing disk files, 7-4
- storing the network analyzer operating system to disc, 5-19
- storing to disc
 - cal kit definitions, 7-4
 - cal sets (calibration data), 7-4
 - hardware state (configuration settings), 7-4
 - instrument state registers (measurement settings), 7-4
 - machine dump (all registers and states), 7-4
 - measurement data (raw, corrected or formatted), 7-4
 - memory registers, 7-4
- sweep frequency, 4-56
- sweep modes
 - frequency list, 4-63
 - ramp, 4-62
 - single point, 4-62
 - step, 4-62
- sweep time

- changing, 2-5, 4-64
- default settings with different number of points, 4-64
- determining optimum, 4-64
- measurement distortion caused by, 4-64
- switch settings
 - HP PaintJet and PaintJet XL, 6-11
 - HP QuietJet and QuietJet Plus, 6-11
 - HP ThinkJet Printer, 6-13
- SWR display format, 4-25
- SWR measurement, 10-3
- symbols and annotations (enhancement labels), 1-6
- synchronization with external monitors, 4-9
- syntax information, program example, 13-18
- SYS/OPER PARAMETERS softkey, 6-20
- system bus, 2-1
- system bus address menu, 1-16
- SYSTEM BUS 'LOCAL' softkey, 5-19
- SYSTEM BUS 'REMOTE' softkey, 5-19
- system bus, selecting for printer or plotter, 6-2
- system description, network analyzer, 1-1
- system functions, 5-2
- SYSTEM** key, 5-2
- system menu, 5-2
- system messages, 1-5
- SYSTEM PARAMETERS softkey, 6-20
- system state query, 13-16
- system status information, getting over GPIB, 13-16

T

- table delay data array, 13-7
- table delay, program example, 13-36
- tabular data, printing, program example, 13-27
- terminator keys, description of, 1-8
- TEST button, 2-3
- test menu, 5-18
- TEST MENU softkey, 5-18
- test port power flatness cal, program examples, 13-36
- test port return cables, 3-11
- test port signal level, estimating, 4-57
- test port signal level, setting, 4-57
- TEST, recessed button, 14-1
- test set check, 14-2
- test sets, 3-7
 - 8511, 3-10
 - custom, 3-10
 - reflection/transmission, 3-8
 - S-parameter, 3-9
- test sets, custom, using, 4-41
- test set too hot message, 14-3
- ThinkJet printer configuration, 6-13
- ThinkJet printer switch settings, 6-13

- ThinkJet printer, using, 6-13
- time/date, setting, 5-6
- time domain
 - advanced concepts, 11-14
 - advantages of step sweep mode over ramp sweep mode, 11-23
 - band pass mode, description, 11-3
 - basic principles of operation, 11-1
 - fault location measurements, 11-5
 - gating, 11-19
 - low pass mode, description, 11-3
 - masking, 11-14
 - measurement considerations, 11-22
 - range, 11-17
 - range resolution, 11-19
 - reflection measurements using time band pass, 11-4
 - response resolution, 11-18
 - source considerations, 11-23
 - test set considerations, 11-23
 - transmission measurements using time band pass, 11-6
 - windowing, 11-15
- time domain band pass mode, description, 11-3
- time domain low pass mode
 - analyzing reflections, 11-9
 - avoiding noise, 11-9
 - description, 11-8
 - interpreting reflection horizontal axis, 11-10
 - interpreting reflection vertical axis, 11-10
 - reflection measurements, 11-9
 - setting frequency range, 11-8
 - trace bounce, 11-12
- time domain measurements
 - introduction to, 2-13
- time domain reflectometry, simulating, 11-3
- title
 - creating, 1-13, 5-5
 - deleting, 1-13, 5-6
- title area, definition of, 1-5
- trace data output and input, program example, 13-22
- Transmission Coefficient, 3-2
- transmission measurement examples, 9-1
- transmission measurements
 - description of, 3-1
 - types of measurement results, 3-2
- transmission/reflection test set calibration, 8-25
- trigger delay, 4-68
- trigger modes, 4-68
- trim sweep, adjusting, 8-29
- TRL 2-Port calibration, performing, 8-24
- typeface conventions, vii

U

uncoupling stimulus settings between channels, 4-66
un-deleting disk files, 7-8
unit number, for external disk drive, 7-9
units keys, description of, 1-8
USER DISPLAY softkey, 7-5
user flatness correction, 4-60
user graphics, plotting, program example, 13-29
user parameters, 4-40
USER PRESET
 definition of, 1-15
using a plotter, 6-22
using =MARKER, program example, 13-21
using receiver calibration, 12-2

V

verification kits, 3-14
verifying your calibration, 8-29
video monitors, 4-9
volume number, for external disk drive, 7-9

W

wait not required, program example, 13-34
wait required, program example, 13-34

X

(x1) key, 1-8

Z

zoom, frequency subset, 8-32

